

HUGO GERNSBACK, Editor

# RADIO CRAFT



RADIO  
ROBOT  
PLANE  
SEE PAGE 694

ALEX  
SCHOMBURG

AUGUST  
1945

25c

RADIO-ELECTRONICS IN ALL ITS PHASES

MADE IN U.S.A.



Motorola Control Control Station located in Redoubt No. 4, Revolutionary War Fortification, overlooking West Point and Hudson River Valley.

**Motorola**  
2-WAY F-M RADIO

## Serves West Point

From left to right, photographs above tell the story of how Motorola two-way radiotelephone is used by West Point “—for all normal police activities, post security and such additional duties as it may be called upon to perform—”.

Sergeant in auto uses Motorola mobile unit to broadcast message which is picked up by antenna on tower and relayed by telephone lines to Sergeant in Military Police Barracks facing Motorola Remote Control unit on desk.

Numerous Motorola mobile units, including one installed on a police cabin cruiser on the Hudson River, provide instant contact with Headquarters, and vice versa, for two-way vocal radio communication.



**FREE** Write today for detailed Motorola Radiotelephone Directory listing more than 1,000 Motorola two- and three-way F-M systems now operating in United States, the Canal Zone and Hawaii.

**GALVIN** MFG. CORPORATION • CHICAGO 51

F-M & A-M HOME RADIO • AUTO RADIO • AUTOMATIC PHONOGRAPHS • TELEVISION • F-M POLICE RADIO • RADAR • MILITARY RADIO



**J. E. SMITH, President  
National Radio Institute**

Our 31st Year of Training Men  
for Success in Radio

# I WILL SEND A SAMPLE LESSON FREE to PROVE I can Train You at Home in Spare Time to BE A RADIO TECHNICIAN

## I Trained These Men



**\$35 to \$45 a Week  
In Own Shop**  
"Previous to enrolling for your radio training I made \$12 per week in a hardware store. Now I operate my own repair shop, and often clear \$35 to \$45 a week." — **FREDERICK BELL**, 70 Golf Ave., St. Johns, Newfoundland.



**\$600 a Year in Spare Time**  
"At present I am doing spare time radio work. I earned money in radio before graduating. My profits for the last twelve months were \$600." — **ERWIN F. BOETTCHER**, Marinette, Wisconsin.



**Chief Engineer  
in Radio Station**  
"When I signed up with N.R.I. I had no other radio experience. I am now Chief Engineer for Station WJBG, and have supervised installation of new modern broadcasting studios and equipment." — **JOHN HENNINGER**, 4744 Meridian Street, Philadelphia, Penna.



**Gets Good Job  
in Civil Service**  
"Since completing your course, I have taken a job with Civil Service as a Radio Mechanic. My work is of confidential nature, but I can tell you the salary is good." — **WALTER R. PRATT**, 418 Margaret Street, Key West, Fla.



I want to give every man who's interested in Radio, either professionally or as a hobby, a copy of my Lesson, "Getting Acquainted with Receiver Servicing" — absolutely FREE! It's a valuable lesson. Study it—keep it—use it—without obligation! And with it I'll send my 64-page, illustrated book, "Win Rich Rewards in Radio," FREE. It describes many fascinating jobs in Radio, tells how N.R.I. trains you at home in spare time, how you get practical experience with **SIX KITS OF RADIO PARTS I send.**

The "Sample" Lesson will show you why the easy-to-grasp lessons of the N.R.I. Course have paved the way to good pay for hundreds of other men. I will send it to you without obligation. **MAIL THE COUPON!**

### Future for Trained Men IS Bright in Radio, Television, Electronics

The Radio Repair business is booming NOW. There is good money fixing Radios in your spare time or own full time business. And trained Radio Technicians also find wide-open opportunities in Police, Aviation and Marine Radio, in Broadcasting, Radio Manufacturing, Public Address work, etc. Think of the boom coming when new Radios can be made! And think of even greater opportunities when Television, FM, Electronics, can be offered to the public! Get into Radio NOW.

### Many Beginners Soon Make \$5, \$10 a Week EXTRA in Spare Time

The day you enroll I start sending **EXTRA MONEY JOB SHEETS** to help you make **EXTRA** money fixing Radios in spare time while learning. You **LEARN** Radio principles from my easy-to-grasp Lessons—**PRACTICE** what you learn by building real Radio Circuits with the six kits of Radio parts I send—**USE** your knowledge to make **EXTRA** money while getting ready for a good full time Radio job.

### Find Out What N.R.I. Can Do for YOU

**MAIL COUPON** for Sample Lesson and **FREE 64-page book**. It's packed with facts about opportunities for you. Read the details about my Course. Read letters from men I trained, telling what they are doing, earning. Just **MAIL COUPON** in an envelope or paste it on a penny postal. **J. E. SMITH, President, Dept. 5HX, National Radio Institute, Pioneer Home Study Radio School, Washington 9, D. C.**

## You Build These and Many Other Radio Circuits with 6 Kits of Parts I Supply

By the time you've conducted 60 sets of Experiments with Radio Parts I supply, made hundreds of measurements and adjustments, you'll have had **PRACTICAL** Radio experience valuable for a good full or part-time Radio job!

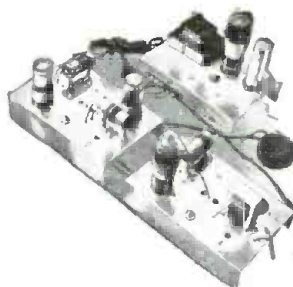

You build the **SUPERHETERODYNE CIRCUIT** (left) containing a preselector oscillator-mixer-first detector, i.f. stage, diode detector-a.v.c. stage and audiotape. It will bring in local and distant stations. Get the thrill of learning at home evenings in spare time while you put the set through fascinating tests!

You build **MEASURING INSTRUMENT** (right) early in Course, useful for Radio work to pick up **EXTRA** spare time money. It is a vacuum tube multimeter, measures A.C., D.C., R.F. volts, D.C. currents, resistance, receiver output.



Building the **A.M. SIGNAL GENERATOR** at left will give you valuable experience. It provides amplitude-modulated signals for test and experimental purposes.

## SAMPLE LESSON FREE

Mail coupon for your **FREE** copy of Lesson, "Getting Acquainted With Receiver Servicing," to see how practical it is to train for Radio at home in spare time. Study it—keep it—use it—without obligation! Tells how Superheterodyne Circuits work, gives hints on Receiver Servicing, Locating Defects, Repair of Loudspeaker, I.F. Transformer, Gang Tuning Condenser, etc. 31 Illustrations.



**My Radio Course Includes  
TELEVISION • ELECTRONICS  
FREQUENCY-MODULATION**

## GOOD FOR BOTH 64 PAGE BOOK SAMPLE LESSON FREE

Mr. J. E. Smith, President, Dept. 5HX  
NATIONAL RADIO INSTITUTE, Washington 9, D. C.

Mail me **FREE**, without obligation, Sample Lesson and 64-page book, "Win Rich Rewards in Radio." (No salesman will call. Please write plainly.)

Name ..... Age .....

Address .....

City ..... Zone ..... State ..... ZIP



**AFTER THE WAR—  
MORE THAN BEFORE!**  
... FROM NATIONAL UNION TO YOU ...



**MORE** instruments, meters and tools... an improved version of the famous N. U. Equipment Plan that was OK'd 60,000 times by service dealers before the war.

**MORE** dealer advertising... newspaper mats, telephone book advertising, mailing pieces, road signs, window displays to make your business prosper!

**MORE** technical data... in the form of Service Engineering Bulletins, manuals, charts and other up-to-date information prepared by N. U. scientists.

**MORE** business helps... new and tested ideas for store layout, stock arrangements, workbench plans, inventory record keeping, and business forms.

**MORE** tubes and parts... to capitalize on the increased use of radio, television and electronic appliances and equipment in homes and industries.

**MORE** sales appeal... through a striking new package design styled to make National Union a recognized emblem for quality merchandise.

**Y**ES, a greater peacetime profit plan is coming... to build new business for radio service dealers and parts jobbers. This plan to build more business for you is backed by the resources of a great and growing company, with front rank engineering and production facilities. National Union can and does assure you...  
"After the War, More than Before!"

NATIONAL UNION RADIO CORPORATION  
NEWARK 2, NEW JERSEY



**NATIONAL UNION  
RADIO AND ELECTRON TUBES**

Transmitting, Cathode Ray, Receiving, Special Purpose Tubes • Condensers • Volume Controls • Photo Electric Cells • Panel Lamps • Flashlight Bulbs

# I'LL SHOW YOU HOW TO SUCCEED IN RADIO

Here's the right training for Big Post-War Pay!

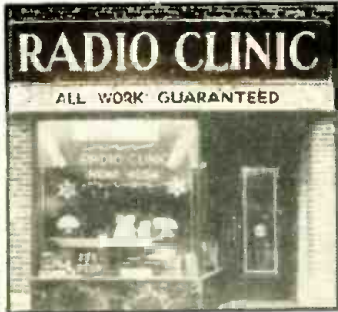

A RADIO SERVICE BUSINESS OF YOUR OWN

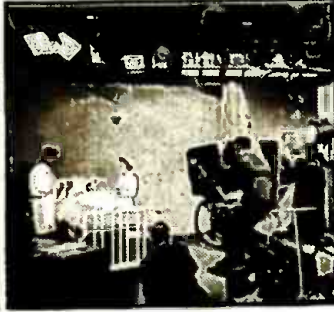

A GOOD JOB IN RADIO & TELEVISION BROADCASTING

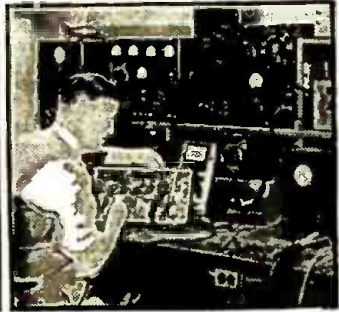

RADIO-ELECTRONIC SERVICE ENGINEER



F. L. Sprayberry, one of the country's foremost Radio Teachers.

## BE A RADIO-ELECTRONICIAN

### NOW! YOU CAN PREPARE AT HOME IN YOUR SPARE TIME FOR THE AMAZING OPPORTUNITIES AHEAD IN RADIO — ELECTRONICS — TELEVISION

The offer I make you here is the opportunity of a lifetime. It's your big chance to get ready for a wonderful future in the swiftly expanding field of Radio-Electronics INCLUDING Radio, Television, Frequency Modulation and Industrial Electronics. Be wise! NOW'S the time to start. Opportunities ahead are tremendous! No previous experience is necessary. The Sprayberry Course starts right at the beginning of Radio. You can't get lost. It gets the various subjects across in such a clear, simple way that you understand and remember. And, you can master my entire course

in your spare time. It will not interfere in any way with your present duties. Along with your Training, you will receive my famous BUSINESS BUILDERS which will show you how to make some nice profits while learning.

#### Prepares You for a Business of Your Own or Good Radio Job

My training will give you the broad, fundamental principles so necessary as a background, no matter which branch of Radio you wish to specialize in. I make it easy for you to learn Radio Set Repair and Installation Work. I teach you how to install and repair Electronic Equipment. In fact, you'll be a fully qualified RADIO-ELECTRONICIAN, equipped with the skill and knowledge to perform efficiently and to make a wonderful success of yourself.



I SUPPLY A FULL RADIO SET for practical easy LEARNING

### SPRAYBERRY TRAINING GIVES YOU BOTH TECHNICAL KNOWLEDGE • SKILLED HANDS

There's only one right way to learn Radio Electronics. You must get it through simplified lesson study combined with actual "shop" practice under the personal guidance of a qualified Radio Teacher. It's exactly this way that Sprayberry trains you . . . supplying real Radio parts for learn-by-doing experience right at home. Thus, you learn faster, your understanding is clear-cut, you acquire the practical "know how" essential to a good-paying Radio job or a Radio business of your own.

#### I'll Show You a New, Fast Way to Test Radio Sets Without Mfg. Equipment

The very same Radio Parts I supply with your Course for gaining pre-experience in Radio Repair work may be adapted through an exclusive Sprayberry wiring procedure to serve for complete, fast, accurate Radio Receiver troubleshooting. Thus, under Sprayberry meth-

ods, you do not have one cent of outlay for manufactured Test Equipment which is not only expensive but scarce.

#### Read What Graduate Says "One Job Nets About \$26.00"

"Since last week I fixed 7 radios, all good-paying jobs and right now I am working on an amplifier system. This job alone will net me about \$26.00. As long as my work keeps coming in this way, I have only one word to say and that is, "Thanks to my Sprayberry training" and I am not afraid to boast about it."—ADRIEN BENJAMIN, North Grosvendale, Conn.

#### • DON'T PUT IT OFF!

Get the facts about my training—now! Take the first important step toward the money-making future of your dreams. All features are fully explained in my big, illustrated FREE Catalog which comes to you along with another valuable FREE book you'll be glad to own. Mail Coupon AT ONCE!

#### Just Out! FREE!

"How to Read Radio Diagrams and Symbols" . . . a valuable new book which explains in simple English how to read and understand any Radio Set Diagram. Provides the quick key to analyzing any Radio circuit. Includes translations of all Radio symbols. Send for this FREE book now, and along with it I will send you another big FREE book describing my Radio-Electronic training.

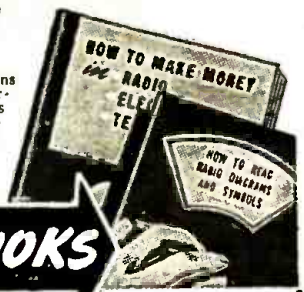

### GET FREE BOOKS

SPRAYBERRY ACADEMY OF RADIO  
F. L. Sprayberry, Pres.  
11000 2085  
Pueblo, Colorado

Please rush my FREE copies of "HOW TO MAKE MONEY IN RADIO, ELECTRONICS and TELEVISION," and "HOW TO READ RADIO DIAGRAMS and SYMBOLS."

Name  Age

Address

City  State

Tear off this coupon, mail in envelope or paste on penny postcard.

# RADIO CRAFT

AND POPULAR ELECTRONICS

Incorporating  
SHORT WAVE CRAFT TELEVISION NEWS  
RADIO & TELEVISION



**HUGO GERNSBACK**, *Editor-in-Chief*  
**FRED SHUNAMAN**, *Associate Editor*  
**I. QUEEN**, *Editorial Associate*  
**ELMER FULLER**, *Shortwave Editor*  
**E. A. WITTEN**, *Technical Editor*  
**A. PASCALE**, *Production Manager*  
**G. ALIQUO**, *Circulation Manager*  
**JOHN J. LAMSON**, *Advertising Director*  
**ALFRED STERN**, *Promotion Manager*

## IN THE NEXT ISSUE

A Simple Low-Volt-Ohmmeter  
Gyrosyn Flux-Gate Compass  
Voltage-Dropping Condensers  
Will the Radioman Gyp You?

Published by Radercraft Publications, Inc.  
Publication Office: 29 Worthington Street,  
Springfield 3, Mass.  
Editorial and Advertising Offices: 25 West  
Broadway, Tel. RE2-9690, New York 7, N. Y.  
Chicago Advertising Office: Radio-Craft, 308  
W. Washington Street, Suite 1413, Chicago 6,  
Ill. Tel. Randolph 7363.  
Cleveland Advertising Office: 405 Erie Bldg.,  
Cleveland, Ohio. Burdette Phillips, Manager.  
Tel. Main 9645.  
Los Angeles Advertising Office: 606 South  
Hill Street, Los Angeles 14, Calif. Ralph W.  
Harker, Manager.  
San Francisco Advertising Office: 582 Market  
St., San Francisco 4, Calif. Ralph W. Harker,  
Manager. Tel. Garfield 2481.  
New England Office: Bridgewater, Conn.,  
W. D. Ward, Manager.  
RADIO-CRAFT is published monthly on the  
25th of the month preceding that of date.  
Subscription rates: United States and pos-  
sessions, Mexico, Central and South American  
countries, \$2.50 a year, \$4.00 for two years,  
\$6.00 for three years. Canada, \$3.00 a  
year, \$5.00 for two years, \$7.50 for three  
years. All other foreign countries, \$3.25 a year,  
\$5.50 for two years, \$8.25 for three years.  
Special rates for members of the Armed Forces  
in U. S., or those addressed by A.P.O. or F.P.O.  
mail, \$2.00. Entered at the post office at  
Springfield as second-class matter under the  
Act of March 3, 1879. All communications  
about subscriptions should be addressed to:  
Circulation Manager, Radio-Craft, 29 Worth-  
ington St., Springfield 3, Mass.

Notice of **CHANGE** of **ADDRESS** should  
reach us at least one month in advance. When  
ordering a change, please furnish an address  
stencil impression from a recent wrapper if  
you can. Address changes cannot be made  
without the old address as well as the new.

### Foreign Agents

London—Atlas Publishing and Distributing  
Co., Ltd., 18 Bride Lane, Fleet St., London,  
E.C. 4.  
Melbourne—McGill's Agency, 179 Elizabeth  
St., Australia.

Text and illustrations of this magazine are  
copyright and must not be reproduced without  
permission of the copyright owners.  
Copyright, 1945, Radercraft Publications, Inc.

## Contents August, 1945 Volume XVI, No. 11

Editorial: The Radio Alarm.....by Hugo Gernsback 689  
Radio-Electronics Monthly Review..... 690

### ELECTRONICS

Television and the Serviceman.....by Gene Conklin 692  
Factory Radiomen.....by E. A. Witten 693  
New Ideas in Receivers.....by Fred Shunaman 695  
New Automatic Radio Compass.....by J. M. Lee and Fred W. Heden 696  
Microwaves, Part II.....by Capt. E. F. Skinner 698  
Electronic Metronome.....by C. C. Gray 699  
Parasitic Oscillations, Part II.....by Dean Stockett Edmonds, Jr. 700

### WAR-TIME RADIO

Cover Feature: Radio Robot Plane.....by Louis Bruchiss 694

### RADIO TRAINING

Negative Feedback.....by J. W. Straede 702  
Power Supply Design.....by James E. Dolan 703  
Detector Circuits, Part I.....by Robert F. Scott 704

### TEST INSTRUMENTS

Unbalanced-Bridge Checker..... 726

### SERVICING

Tube Replacements, Part II.....by I. Queen 701  
Planning the Service Shop.....by Robert Dixon 705  
Radio Voltage Tests.....by Jack King 706  
More on Battery Set Conversions.....by Gerald Evans 710

### CONSTRUCTION

Save the Battery Sets.....by Earl T. Hartline 708  
New Shortwave Converter.....by Wm. Nimmons 710

### DEPARTMENT

Why Not..... 708  
World-Wide Station List.....by Elmer R. Fuller 712  
New Radio-Electronic Devices..... 717  
Radio-Electronic Circuits..... 718  
Try This One!..... 720  
Progress in Invention.....by I. Queen 724  
Available Radio-Electronic Literature..... 744  
Communications..... 745  
Book Reviews..... 747

### ON THE COVER

Our cover this month illustrates the artist's idea  
of future bombing with long-trajectory flying tor-  
pedoes directed by radio. Such precision-type aerial  
bombs could be released a safe distance away  
from the target, then guided to their objectives  
with the precision of a "Kamikaze" suicide bomber.



**"YOO HOO, BABY... YOU AND I  
AND ECHOPHONE GOTTA DATE  
IN THE NEAR FUTURE ON THE  
CITIZENS' RADIOPHONE BAND"**\*



### HOGARTH MAKES A DATE

Hogarth's date with the future embraces new possibilities for Echophone. There will be Echophone equipment for use on the citizens' radio communications service band. It is certain to be low in price, high in performance and completely dependable. The present EC-1 covers from 550 kc. to 30 Mc. on three bands . . . electrical bandspread on all bands . . . self-contained speaker . . . 115-125 volts AC or DC.

**ECHOPHONE**  
*"The Ears of the World"*

\*Citizens' radio communications service band, 460-470 Mc., recently proposed by the F.C.C.

**ECHOPHONE RADIO CO., 540 NORTH MICHIGAN AVE., CHICAGO 11, ILLINOIS**

# SPRAGUE TRADING POST

A FREE Buy-Exchange-Sell Service for Radio Men



## SPRAGUE TC TUBULARS

The most famous, most widely used by-pass capacitors in the entire history of Radio. Ask for them by name!

**"Not a Failure in a Million!"**

**URGENTLY NEEDED**—70LGT. 50L6GT tubes. Cash or will trade parts. Wayne Van Driest, Cedar Grove Wis.

**FOR SALE OR TRADE**—New radio chassis jacks: G-E FM radio; 200' home wire; 400' No. 14 house wire; 175' 2-wire BX (armored cable). Need six gen. tube radio; electrical appliances or sell for cash. Herman Grossman, 5015 Wayne Avenue, Philadelphia 44, Pa.

**WILL TRADE**—Philco 41-83 less batteries for usable 16mm movie projector. Gerald Miller, Washington St. Extension, St. Mary's, Pa.

**WANTED**—Rider manuals and books by Rider. Pfc. Joseph Geviado, 913077, U.S.M.C., M.N.F.O.T.D., N.A.S., Vero Beach, Fla.

**FOR SALE**—Readrite set tester No. 710-A, has three meters, plug with five adapters, test brods. F. C. Davis, Pipersville, Pa.

**WANTED**—Wireless phono oscillator. Guy P. Jennings, 230 Washington Ave., Covington, Va.

**FOR SALE OR TRADE**—All-wave oscillator No. OS-3, complete with instructions. What have you? Urgently need tubes. Send list. Gehlen's Radio Service, 74 East First St., Clifton, N. J.

**FOR SALE**—Weston 772 in A-1 condition. Want RCA 150 test oscillator VTVM in poor condition or inoperative. C. W. Chaplin, Bird Island, Minn.

**WANTED**—Neon sign—"Radio Service." State size and price. JayCee Radio Shop, 11613 Mansfield St., Detroit 27, Mich.

**URGENTLY NEEDED**—117Z4GT, 1N5, 1H5 and 1Q5 tubes. Have 35Z5, 7C6, 7B7, 1B5-25N, 6K7 and 76 used tubes to trade. Sgt. R. D. Serra, 260th BU, Box 401, Strother Field, Winfield, Kans.

**FOR SALE OR TRADE**—2051, 2A4G, 6H4, 38, 59, 53, 6B8, 6SD7, 11H4, 7H7, 1C5, etc., new tubes. What have you? Radio Electronic Shop, 985 Barret Ave., Louisville 4, Ky.

**FOR SALE**—New tubes in sealed cartons at OPA list. L. Stein, 456 Bedford Ave., Mt. Vernon, N. Y.

**URGENTLY NEEDED**—Dumont 3" scope No. 164E or 3" RCA No. 153C or equivalent; good V-O-M; late model tube tester and 1A7, 1Q5, 1H5, 1N5, 50L6 and 80 tubes. Joseph Albricht, 415 S. Main St., Tipton, Ind.

**FOR SALE**—RCA ehanalyst; Jackson universal oscillator; Racon Giant units; Pioneer geno-motor type E; tubes, condensers, and radio parts. Want professional recorder with mike and amplifier from 8 to 30 watts. John J. Levine, 625 Main St., Worcester 8, Mass.

**WANTED**—Riders 3, 4, 11 and up; capacity tester; VTVM; scarce types of tubes; chassis holder frame and other shop fixtures. Everett L. Sawyer, 521 Grinnell St., Key West, Fla.

**WILL TRADE**—HY-75 in original carton for new HY-615; will pay cash for UHF equipment and high voltage tubes. Richard Cass, 18 Shoreacille Rd., Newton 58, Mass.

**WANTED**—New or used radio parts and equipment, also 78 rpm constant speed motor and pickup. What have you? Edward Howell, Dillon, S. C.

**FOR SALE OR TRADE**—Over 100 tubes and adapters, transformers, radio chassis and other parts. S. R. Smeltzer, Red Lion, Pa.

**WANTED**—RME LF90 converter and Super-rider tube checker No. 1240. John Lininger, 3942 Drexel Drive, Toledo, Ohio.

**FOR SALE**—R.C.P. No. 803 portable tube and set tester with No. 506 analyzer unit in cover. Also Philco audio sig. gen. or will exchange for Supreme 562 audolyzer. S. S. Schilssel, 3957 Gouverneur Ave., New York 63, N. Y.

**FOR SALE**—New tubes, send for list; also phono motor; VTVM for tele. testing and other radio parts. John D'Alessandro, 2223 S. Juniper St., Philadelphia 48, Pa.

**FOR SALE**—Surplus tubes, send for list; auto aertials; J.F.D. adjustable ballast tubes types "B"; 5 lbs. spools soldering, etc.; 35 watt P.A. system, complete with speakers, microphone, steel baffles and cable, either 100v A.C. or 6v D.C. current. What have you? Dill's Radio Service, Union, S. C.

**WILL TRADE**—Transmitting parts from power transformers to meters. Want Stanco transmitter. E. L. Thompson, W4FJC, 1531 Charon Rd., Jacksonville 5, Fla.

**FOR SALE**—4-203-A Taylor Tubes \$10 ea., 75-6F6G, 30-6D6, 25-12SR7, 25-6SL7, 12-6J5 tubes 40% off list. 100-20x20 mfd. 150v. condensers with mounting strap 78c ea. L. S. Flannery, Spring and Silver Sts., New Albany, Ind.

**WANTED**—Auto radios any quantity any type; also auto antennas concealed or cowl type. Bonded Service, 27 W. 170th St., New York 52, N. Y.

**WANTED**—Wireless phono oscillator with input for crystal pickup. 110v. A.C. Glenn S. Pidge, 199 C. St., Brawley, Calif.

**WILL TRADE**—Transmitter equipment tubes RK-829; CRP-72; CTL705A; RK807; 1B18; 3AP1-906P1 cathode ray tube. Need six ken.; oscillator tube checker for all type tubes and other test equipment. R. W. Quillian, Box 714, Somerville, S. C.

**FOR SALE**—Kato converter changing 32v D.C. to 110v A.C., 60 cycle, 150 watt output. Almost new. L. P. Johnston & Son, Omro, Wis.

**WANTED**—Radio parts and 76, 70L7GT, 25B8GT tubes. Jimmy Lovett, 823 W. Third St., El Dorado, Kans.

**FOR SALE**—New Meissner sig. splitter and new No. 101 Rollindex unit for Radio City tube testers. John Connel, Jr., 1163 Oak St., S.W., Warren, Ohio.

**WANTED**—Altee Lansing duplex speaker. Pvt. Chas. Richter, No. 33794791, Squadron C-3, Smyrna Army Air Field, Smyrna, Tenn.

**WILL TRADE**—Triplet 1200A, multi-range, D.C.-A.C., with test cords and batteries. Want 8 x 10 view camera. E. C. Welch, 411 N. Main, Hutchinson, Kans.

**FOR SALE OR TRADE**—Day-Rad tube tester No. 48-381. Want Riders, VTVM or what have you? Bernard DePrimo, 178 E. Ave., Norwalk, Conn.

**FOR SALE**—EC-3 communications receiver and Emerson portable h.c. receiver. F. F. Knapf, 6508 Montgomery Rd., Cincinnati, Ohio.

**WILL TRADE**—Riders manual abridged 1-5. Want 10 or 11. Frank Way, 406 S. 7th St., Newark, N. J.

**FOR SALE OR TRADE**—Clough Brengle 3" oscilloscope; Thompson-Levering Wheatstone bridge; 1 to 60 high speed drills; polished flutes in Hault Index; aero chassis cradle. Want Riders, RCA Voltinimyst, Jr., new tubes and other salable merchandise. Radio and Music Shop, 4520 S. Western Ave., Los Angeles 37, Calif.

**WANTED**—Long list of tubes and radio parts. What have you? James Bernord, 302 E. 2nd St., Elmira, N. Y.

**FOR SALE**—2-024, 2-1H5, 2-12SQ7 tubes. Want 12J7 and 12A7. Fred Schultz, 3573 Fincastle, Louisville 4, Ky.

**URGENTLY NEEDED**—Readrite No. 432A tube tester, RCP No. 506C or 504C analyzer and other test equipment for service lab. Joe Kishiyama, 3305A, Newell, Calif.

**WANTED**—Communications type radio to operate on 115v A.C. Should have broadcast and SW to 25 m.c. to be used overseas as morale builder. 1st Lt. James W. Brumbaugh, Bldg. 2013, C.C. Area, Ft. Monmouth, N. J.

**FOR SALE**—New and used tubes, wire, condensers, etc. Send for list. Anton Gonzalez, 603 Prospect Ave., Bronx 55, N. Y.

**URGENTLY NEEDED**—25Z5 or 25Y5 tube. Daryl Davis, Rt. 2, Box 285, Sabastopol, Calif.

**WANTED**—6" pm speaker with output transformer and 5 prong plug in coils adapted to 360 variable condenser or equivalent. Dallas L. Barrett, Jr., Kentfield, Calif.

**FOR SALE OR TRADE**—0 to 5; 0 to 10 milliamper meters; Readrite capacity meter; 2-0 to 50 D.C. voltmeters and parts from 150 radios. What do you need? Want good tube tester. E. R. Smith, RFD No. 3, Kenton, Ohio.

**FOR SALE OR TRADE**—6G6G, 6T7G, 6B7, 6H7GT, 6U7G, 6B8G, 6K6GT/G tubes; General Cement Co. belts; Majestic parts; volume controls. Want Gernsbaek manuals 3 and 5 and Magnaformer 29 or 30. C. E. Peters, 2925 Apple St., Lincoln, Neb.

**FOR SALE**—Lot of 244 tubes. Cash's Radio Service, Aldrich, Minn.

**WANTED**—Tube tester and multi-meter. L. Aubrey, 125 Fifth Ave., Butler, Pa.

**WILL TRADE**—#088 Philco six gen. battery-operated, for small ac-de radio or what have you? S. Brzek, 1424 Venoy Rd., Wayne, Mich.

**FOR SALE**—Transmitting and receiving apparatus. H. F. Southwick, 251 Bank St., Fall River, Mass.

**WILL TRADE**—Hard-to-get tubes and new electric Telaphy with taps and instructions. New speed key and other parts. What have you? Parker Radio Service, 416 Market St., Logansport, Ind.

**WANTED**—Riders manuals 7 to 13; RF oscillator and other test equipment. J. Tabaczynski, P. O. Box 99, Milwaukee Junction Station, Detroit, Mich.

**FOR SALE**—Zenith radio nurse; G-E FM receiver; new and used tubes; 2v. farm radio; 32v table model Silver-tone; Day-Rad tester; ac-de meters; Ohms, etc. Gouma Electric Service, Dorchester, N. J. P. O. Box 38.

**FOR SALE OR TRADE**—Latest Superior speedometer multimeter PB200 or G-E umimeter. Want 50L6, 35Z5, 25Z5, 12v., 1H5, 35L6 new tubes. Ray Viglione, 276 Washington St., Perth Amboy, N. J.

### YOUR OWN AD RUN FREE!

This is Sprague's special wartime advertising service to help radio men get needed parts and equipment, or dispose of radio materials they do not need. Send your ad today. Write PLAINLY or PRINT—hold it to 40 words or less. Due to the large number received, ads may be delayed a month or two, but will be published as rapidly as possible.

Sprague reserves the right to reject ads which do not fit in with the spirit of this service.

HARRY KALKER, Sales Manager

Dept. RC-85, SPRAGUE PRODUCTS CO., North Adams, Mass.  
Jobbing Sales Organization for Products of the Sprague Electric Co.



# SPRAGUE CONDENSERS KOOLOHM RESISTORS

T.M. REGISTERED U. S. PATENT OFFICE

Obviously, Sprague cannot assume any responsibility, or guarantee goods, services, etc., which might be exchanged through the above advertisements



**THE  
MODERN  
A-B-C  
DeFOREST  
WAY!**

# Learn RADIO ELECTRONICS quicker·easier AT HOME



The famous Dr. Lee DeForest supervised the preparation of DeForest's Training

**You GET **A**  
LOOSE-LEAF LESSONS**

DeFOREST'S TRAINING includes 90 loose-leaf lessons, prepared under the supervision of one of the world's foremost Radio authorities, Dr. Lee DeForest—inventor of the audion tube which has helped make modern radio possible... holder of over 300 radio patents... and often called "Father of Radio."



**YOU CAN BUILD 133 FASCINATING EXPERIMENTS WITH THIS EQUIPMENT**

**FOR A BETTER OPPORTUNITY TODAY — PLUS A BETTER POST-WAR FUTURE**  
Get into Radio and Electronics—a billion dollar OPPORTUNITY FIELD OF TODAY that promises such a THRILLING POST-WAR FUTURE. See how you may get ready for a GOOD JOB... or a BUSINESS OF YOUR OWN... BETTER PAY and HIGHER RATING in military service. Read how DeFOREST'S prepares you for your start in Radio-Electronics in your spare-time at home—easier, quicker because it includes BOTH "Learn-by-Seeing" Movies and "Learn-by-Doing" Radio Parts and Assemblies. You'll find all these answers, and more, in DeFOREST'S big, illustrated book, "VICTORY FOR YOU!" It's FREE.

**You Get This Exclusive 3-WAY Combination of Radio Training Advantages**

You READ... you SEE... you DO! (A) You get well-illustrated lessons prepared the modern loose-leaf way to help keep your training up-to-date. (B) You get real, practical RADIO EXPERIENCE from eight big kits of standard Radio parts and assemblies. (C) You get the use of a 16 mm. MOVIE PROJECTOR AND 12 TRAINING FILMS. You S-E-E "hidden actions" of Radio circuits from fascinating, easy-to-learn-from ACTION MOVIES. You get what we think are the major Radio training aids—AT HOME!

**You Get EMPLOYMENT SERVICE**

DeFOREST'S Training includes an effective EMPLOYMENT SERVICE that has long-established contacts with many companies employing trained Radio men. You enjoy this valuable assistance once you are trained. DeFOREST'S is affiliated with the DeVRY CORPORATION—well known manufacturer of Motion Picture Sound Equipment.

****B** You WORK AT HOME WITH PRACTICAL EQUIPMENT**

You enjoy a "Home Laboratory." You get valuable Radio experience by building modern Radio circuits that operate; also, "Electric Eye" devices, Light Beam Transmitter, Public Address System, Wireless Microphone, etc. 133 fascinating experiments in all—in spare time, at home.

****C** You SHOW MOVIES AT HOME**

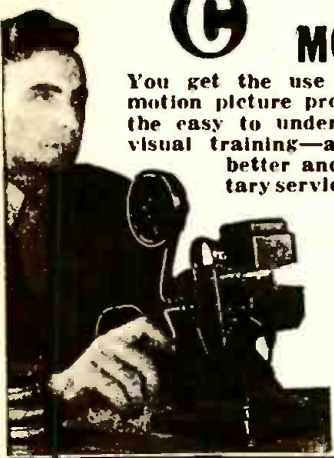

You get the use of a genuine DeVry 16 mm. motion picture projector and films which provide the easy to understand, highly effective modern visual training—a method used today to train better and faster in war plants and military service. Radio principles come to life! ... you see electricity in action, electronics made CLEAR the EASIER DeForest way. Get DeForest's BIG FREE BOOK, "VICTORY FOR YOU"—a key to a good pay job in the electronics industry, to a business of your own or to better military rating and pay. Act now. Mail the coupon today!

**SEND FOR FREE BOOK!**

## DeFOREST'S TRAINING INC., Chicago, Ill

DeFOREST'S TRAINING, INC.  
2535-41 N. Ashland Ave., Dept. RC-B8  
Chicago 14, Illinois, U. S. A.

Please send me—FREE and WITHOUT OBLIGATION—illustrated book, "VICTORY FOR YOU," showing how I can prepare for Radio with your Home Movies and Laboratory Kits.

Name..... Age.....  
Address.....  
City..... Zone..... State.....  
 If under 16, check here for special information.  If a veteran of World War II, check here.





## LONG SCALE, WIDE RANGE VOLT-OHM-MILLIAMMETER

### DOUBLE SENSITIVITY D. C. VOLT RANGES

0-1.25-5-25-125-500-2500 Volts,  
at 20,000 ohms per volt for greater accuracy on  
Television and other high resistance D.C. circuits.  
0-2.5-10-50-250-1000-5000 Volts,  
at 10,000 ohms per volt.

### A. C. VOLT RANGES

0-2.5-10-50-250-1000-5000 Volts,  
at 10,000 ohms per volt.

### OHM-MEGOHMS

0-400 ohms (60 ohms center scale)  
0-50,000 ohms (300 ohms center scale)  
0-10 megohms (60,000 ohms center scale)

### DIRECT READING OUTPUT LEVEL DECIBEL RANGES

-30 to +3, +15, +29, +43, +55, +69 DB

TEMPERATURE COMPENSATED CIRCUIT FOR  
ALL CURRENT RANGES D. C. MICROAMPERES  
0-50 Microamperes, at 250 M.V.

### D. C. MILLIAMPERES

0-1-10-100-1000 Milliamperes, at 250 M.V.

### D. C. AMPERES

0-10 Amperes, at 250 M.V.

### OUTPUT READINGS

Condenser in series with A.C. Volts for output  
readings.

### ATTRACTIVE COMPACT CASE

Size: 2½" x 5½" x 6". A readily portable, completely  
insulated, black, molded case, with strap handle.  
A suitable black, leather carrying case (No. 629)  
also available, with strap handle.

### LONG 5" SCALE ARC

For greater reading accuracy on the Triplet  
RED • DOT Lifetime Guaranteed meter.

### SIMPLIFIED SWITCHING CIRCUIT

Greater ease in changing ranges.

Write for descriptive folder giving full technical details



# Triplet

ELECTRICAL INSTRUMENT CO. BLUFFTON, OHIO

RADIO-CRAFT for AUGUST, 1945

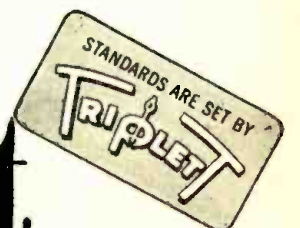



# KEEP UP WITH RADIO TELEVISION and ALLIED ELECTRONICS

Get in on the new developments in the fast expanding Radio Industry. Take your place in the field of Television. Make more money as a Modern Service Expert. Own and operate Your Own Business. Learn the latest Trade Secrets and Short Cuts through

## SHOP METHOD HOME TRAINING

Don't waste time! Radio, F.M., Video (television), and the whole field of Electronics is changing fast. If you are in the radio business now you know what you are up against—new methods, new techniques, new equipment. Today you must solve NEW problems in servicing and repairing F.M. receivers. Tomorrow there will be thousands of Television Receivers to handle. Right after the war science promises NEW Electronic devices for household, factory and business.

**THIS MEANS NEW OPPORTUNITY FOR YOU IF YOU ARE READY**  
The thing to do is to GET READY. Find out about the marvelous new method of preparation—SHOP METHOD HOME TRAINING. Fill out and send in the coupon now.

### Keep in Step With Shop Progress

Here is the truly modern system of training. It matches the RAPID PROGRESS CONSTANTLY BEING MADE in Radio, Television and Electronics. It is up to date in every way because it comes right from the busy radio training shops of National Schools where experiments and developments are being carried on—where discoveries are being made all the time.

It is based on real shop methods—on the handling of real shop jobs. Only National can offer you SHOP METHOD HOME TRAINING because only National has the big busy shops to develop this method.

And it is time tested too. National Schools has been training men for industry, for government, for business for more than a third of a century. In essence you get at home

—in your free time—the very same kind of instruction that has helped thousands upon thousands of ambitious men to more pay and greater opportunity—that has set thousands of men up in business with little or no capital. You owe it to yourself to read the book, "Your Future in Radionics"—sent to you FREE if you fill out and mail the coupon.

### Make Extra Money Right from the Start

You get ahead fast with National Training. Many beginners make good money on the side fixing radios and doing service work. You can turn your knowledge into cash after the first few lessons. Progress is rapid. You can actually SEE YOURSELF GET AHEAD, because the National Shop Method is so sound and practical.

### All This Modern Electronic Equipment and More Comes to You as Part of Your National Course



### NATIONAL TRAINED MEN NOW MAKING THE BEST MONEY IN HISTORY

The real value of National training shows up in the quick progress our men make on the job. Joe Grumlich of Lake Hiawatha, N. J., turned down a job most men would welcome. He writes: "My latest offer was \$5,800.00 as radio photo engineer, but I am doing well where I am now engaged. I am deeply indebted to National."

Ely Bereman, now on Station WOR, told us: "My salary has been boosted considerably and at the present time I am making over \$3,000.00 per year, thanks to National Training." And from the far-off Hawaiian Islands, Wallace Choi sends this: "I am averaging \$325.00 a month. I will say that I honestly owe all this to the excellent training I had at National."

National is proud of the progress graduates are making all over the world. Read about their records yourself in the books we send you FREE.

### Get this FREE Lesson

Get a FREE lesson from National.

Study it over at your convenience. See for yourself how thorough, how sound and how practical — yet how amazingly easy it is to learn and understand. NO SALESMAN WILL CALL ON YOU FROM NATIONAL SCHOOLS. National points out the opportunity—offers you the training and experience, prepares you for greater things in life. But it is up to you to act for yourself. And the first step is to fill out the Coupon and mail it. Get FREE lesson, the big Radio Book, and then decide.



### Get the Real Experience Before You Tackle a Job

Walk into a brand new job and go to work with assurance—the assurance that comes with knowing how—that comes with handling the tools—with working with and operating actual electronic equipment sent to you from the laboratories and shops of National Schools. There's nothing to equal learning by doing. In your National training you build real sets—a super-heterodyne receiver, a signal generator—literally scores of various electronic devices with your National equipment.

Learn basic principles—FIRST THINGS FIRST. Get your knowledge and experience first hand under the personal guidance of seasoned, practical National instructors working personally with you. You know the very how and why of Radio—Television, Electronics.

Not only do you gain marvelous actual experience by this method of learning but you have valuable equipment you will use on the job in the practice of your profession as an electronics expert. Mail the coupon and learn what this means to you.

### After the War What?

Face realities now! Is the job you're doing going to last? What is its future and yours? How are you going to meet conditions when the world returns to civilian production? There's no use in fooling yourself. Radio is a BIG, SOUND, WELL ESTABLISHED BUSINESS.

There are millions of sets in the Country that need reconditioning right now. There is a big demand for millions more that have to be built—largely by trained men. F.M. is here to stay. BUT RADIO IS ONLY ONE FIELD OF ELECTRONICS. Television is sure to come. Sets must be built, installed, serviced and repaired. Who's going to do it? Make up your mind that you are—and at a great big profit—for years to come.

When you hang up your uniform—when your war job folds up will you step out proudly into a new field—an essential established industry—perhaps into a business of your own?

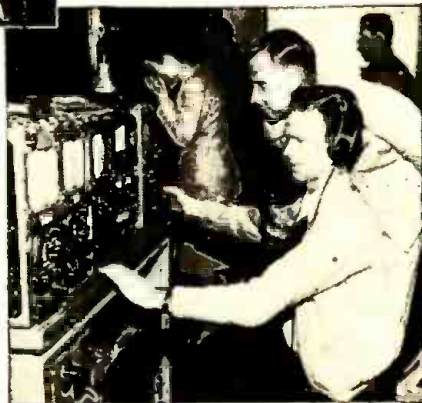

The above pictures were made in and around a modern television studio. Think what new opportunity is open to you in this great new field if you are ready for it. Prepare now. National training includes a good foundation in Television and F.M. Get the facts. Send the Coupon.

## NATIONAL SCHOOLS

LOS ANGELES 37, CALIFORNIA EST. 1905



### MAIL OPPORTUNITY COUPON FOR QUICK ACTION

National Schools, Dept. 8-RC  
4000 South Figueroa Street, Los Angeles 37, California.

(Mail in envelope or paste on penny post card)

Mail me FREE the two books mentioned in your ad, including a sample lesson of your course. I understand no salesman will call on me.

NAME ..... AGE.....

ADDRESS .....

CITY ..... STATE .....

Include your zone number

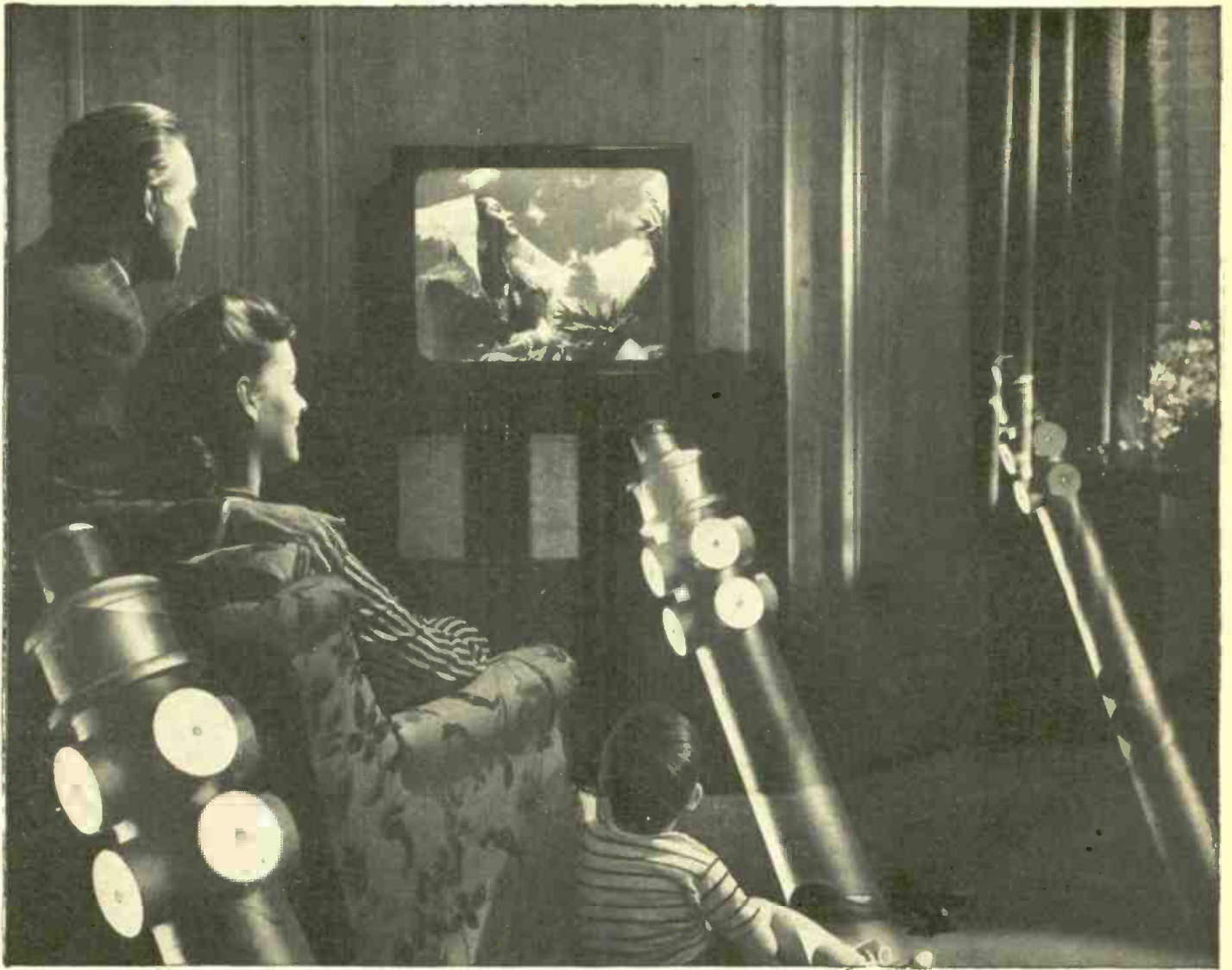

RCA radio-relay towers—like those phantomed above—will leap the hurdle of *distance* in post-war television.

## ***Coast-to-Coast Television...through "Radio-Relay"***

For a long time it looked as though post-war television might be confined to local stations. Only persons within a fifty-mile radius of New York, for example, would see the important television broadcasts from NBC's pioneer station WNBT, atop the Empire State Building.

That was because the ultra short waves that carry television do not bend with the curvature of the earth. They go in a straight line out to the horizon—and then keep on going into the sky.

But today, television's big handicap of short range has been completely overcome—by RCA scientists and engineers.

The *radio-relay* was developed—a tower that "bounces" television programs to the

next tower 30 to 50 miles away. Through a network of these automatic, unattended, radio-relays, coast-to-coast television is made practical.

This is but one more example of how RCA research constantly "makes things better." Such research is reflected in *all* RCA products. And when you buy a television set, or radio-phonograph, or anything made by RCA, you enjoy a unique pride of ownership. For if it's an RCA you can be sure it is one of the finest instruments of its kind that science has achieved.



C. W. Hansell, RCA specialist in transmitters and relays, is shown here with a radio-relay reflector that can "bounce" radio messages, radiophotos and Frequency Modulation programs at the same time that it relays television!

## **RADIO CORPORATION of AMERICA**

PIONEERS IN PROGRESS



# THE RADIO ALARM

... Postwar radio developments urgently require a device which will make it possible to notify owners of radio sets by means of visual or aural signals ...

HUGO GERNSBACK

**O**WNERS of radio sets for some years past, have felt the urgent need for a device which would automatically turn on their receiver when important news occurs.

The death of President Roosevelt demonstrated the potential importance of such a device. Many people did not know of the President's death until hours after the news had been broadcast. In time of impending disastrous floods, earthquakes, tornadoes, great fires, sudden war (such as Pearl Harbor), our radio sets should be equipped with a simple and sure device whereby it will be possible for a broadcast station to turn them on if such an emergency should arise.

During the next few years we will have handie-talkies and other portable radios coming into use. These will not function unless they are equipped with a positive radio alarm. The person afield must have a means of knowing that he is wanted and should listen in. It is obvious that he cannot listen in continuously. For war purposes there is not such a great necessity for a radio alarm. When a soldier carrying a walkie-talkie, or handie-talkie, wants to talk to headquarters or to a command post, someone there listens in at all times. Obviously this is impossible for handie-talkies as well as walkie-talkies under peace conditions.

Here then we require either a visual signal such as a flashing lamp, a red or other colored disk that would suddenly appear, or a bell or buzzer. In our home radio sets the problem is not so very difficult, it merely requires a special radio pilot tube which is turned on continuously. Then when the alarm signal comes in the signal will trip the relay and the set is automatically turned on.

The *modus-operandi* at the broadcast station will be that a special tone or musical note of a specified characteristic is emitted. Such a special signal will be broadcast only during an emergency where it is of utmost urgency that all radio listeners shall be informed of the news about to be heard. There are no technical difficulties in all this and we have the means to do it today. There only remains the economic problem that the special pilot tube must be kept turned on—24 hours a day. That means a certain amount of current will be used right along and further that the life of such tubes—constantly operating for months and years—will be

comparatively short. It also follows that such tubes or devices must be replaced periodically. The cost of replacing them would not be a great burden. Most listeners will be willing to pay for it, because it will be their insurance that if news of national or international importance occurs, they will be informed instantly.

When it comes to portables such as walkie-talkies, handie-talkies and others the problem becomes more complicated because these use batteries. If the batteries have to be kept in the circuit continuously they will soon wear out. Here then, we require a different type of radio alarm, which should draw very little or no electric current from the batteries. This problem is not insoluble either. We can, for instance, with good results resurrect the old-time coherer, which was superseded by the radio tube and became obsolete at that time. The coherer is a simple device which uses almost no current at all, except when electro-magnetic waves strike it and make it operative. The regulation coherer is not a sure device but the Marconi vacuum-exhausted coherer is pretty rugged, even against shocks. Moreover, even in Marconi's days it was possible to eliminate extraneous waves, such for instance as those created by lightning and other stray charges. A number of patents on such weeding-out circuits were taken out by the Marconi people almost a generation ago. It should be possible to further perfect the vacuum coherer and make it completely reliable under all circumstances. This does away with using an electronic tube. Practically no battery current is used until the special signal energizes it, which trips a simple relay and puts the receiver into operation.

It is quite possible that the coherer idea will be brought up to date in such a way that it can be used universally and with the efficiency of a modern radio tube.

The coherer, furthermore, has a certain advantage in that it can be manufactured much cheaper than a radio tube. A simplified relay can also be manufactured at a very low cost today. It will be seen that by this combination of an old-time device, radio may get an efficient alarm that works under all circumstances.

There may be many other ideas as to how the problem can be solved in an equally efficacious manner, by other radio-electronic means (Continued on page 730)

## Radio Thirty-Five Years Ago

In Gernsback Publications

FROM the July and August 1910, issues of MODERN ELECTRICS:

- The Gernsback Detectorium, by A. C. Austin, Jr.
- Image (Television) Transmitting Devices, by A. C. Marlowe.
- New Receiving Condenser, by Louis Driggs.
- Poulsen System of Wireless Telephone, by C. F. Ewell.
- High Frequency Oscillations, by Moore Stuart.
- The Oscillation Transformer, by M. A. Deviny.

### HUGO GERNSBACK Founder

Modern Electrics	1908
Electrical Experimenter	1913
Radio News	1919
Science & Invention	1920
Radio-Craft	1929
Short-Wave Craft	1930
Wireless Association of America	1908

Automatic Key and Aerial Switch.  
Transmitters (microphones) Using  
Flame and Liquids.

Some of the larger libraries in the country still have  
copies of Modern Electronics on file for interested readers.

Instrument for Measuring Condenser Capacities.

- Electric Violin Player.
- Railroad Wireless Communication, by Dr. Lee DeForest.
- Notes on Wireless Interference, by Bernadotte Anderson.
- High Frequency Wave Apparatus.
- A New Wireless Telephone.
- Detector (break in) Condenser.
- A Non-Inductive Potentiometer, by H. W. Secor.
- The Construction of an 80-Foot Mast, by L. J. Nadan Du Treil.

**T**ONE signals and Radiotype apparatus as a means of combatting crime were demonstrated at the recent visit of the New York State chapter of the Associated Police Communications Officers to Schenectady, G-E reported last month.

The Radiotype equipment uses a standard electromatic typewriter applied to communications apparatus. In full automatic operation, copy is typed on a sending typewriter which perforates a tape. This tape is "read" by an automatic transmitting head which keys the electronic communications unit, sending out a tone signal. This tone signal is sent over a radio circuit, the same as a voice signal. At the receiving end the tone is fed into an electronic unit which selects the proper keys on the receiving typewriter which prints the message. The G-E boys caught the tones on a magnetic recorder, later running the wire off again to actuate the receiving apparatus which typed out the message. Transmission by Radiotype over regular FM circuits was also demonstrated to the visiting police communications men. At the Helderberg mountain site of G.E., 50 police officers were shown a one-way demonstration of Radiotype when messages were sent from the company's plant, about 13 miles away. This operated on 35.46 megacycles. The engineers had voice communication between the mountain and plant by standard FM emergency equipment and used the same equipment to transmit the Radio type.

While no attempt was made to multiplex voice and Radiotype over the same carrier in this demonstration, the engineers explained that this has already been done without interference on either channel.

Voice communication was also demonstrated on a frequency of 161.775 megacycles using experimental mobile FM equipment. (FM voice communication by police radio systems have heretofore been in operation on frequencies between 30-40 megacycles and between 116-119 megacycles.) This new frequency (161.775 megacycles) is in that part of the radio spectrum which the Federal Communications Commission has proposed for new emergency communication uses by police and fire departments.

A car was equipped with 4-watt experimental FM radio apparatus which enabled the engineers in the car to talk from various parts of the Capital District to engineers and their guests at the G.E. transmitter site in the Helderberg Mountains. The car transmitter was heard at various distances up to 50 miles away. The channel from the Helderbergs to the car was conventional 30-40 megacycles equipment; the talk-back was on 161.775 megacycles.

# Radio-Electronics

## Items Interesting

**A**GREEMENT for international cooperation to eliminate radio interference was reached last month between the American Standards Association, the British Standards Institution and the Australian Standards Association.

Increasing use of such electronic devices as diathermy machines, which can create interference clear round the world, has made interference an international rather than a local problem. Electrical systems of long-range aircraft, if improperly designed, can seriously interfere with radio reception over a wide pathway.

Europe has been more keenly aware of interference problems in the past than has the United States. Thus certain types of electrical apparatus manufactured here are not acceptable on the other side of the Atlantic, due to the interference they cause. American exporters will therefore benefit from an international set of standards.

**C**O-OPERATION between the various groups of the broadcasting industry was held by J. L. Fly, former FCC head, to be essential if prospective postwar radio users were not to be scared off by claims and counter-claims of FM television, AM, and even facsimile, as to their respective places in the radio world. Speaking last month before the American Marketing Association, he pointed out that the radio listener would not clutter up his rooms with a variety of machines, each one designed to pick up a special type of emission, but would want one receiver, which would take care of all his needs.

Underscoring the importance of finding a solution to this problem, he reminded the radio group of the heavy plant investment and heavier operating costs faced by the industry in pushing new broadcasting developments. "What will the broadcaster use for money," he asked, "if at the same time he is dividing his own audience into halves or even into thirds?" A single unified service will enable the broadcaster to serve a continuing audience without competing with himself, Mr. Fly said.

**M**AINTENANCE of present radio receivers will take precedence over production of new sets in the allotment of new radio tubes, the War Production Board stated last month. When new tubes are made in quantity, strict priority will be given to repairmen for the purpose of keeping existing radios in service, over manufacturers who would use them in new receivers.

WPB officials suggested that authorization of 4,000,000 civilian radio tubes per month might soon be forthcoming, but were silent as to just how soon that might be.

Army spokesmen reported that cancellations of military tube orders were being made in small numbers, and stated that the Army's present stockpile was now being re-examined and might possibly reveal stocks which would make further cancellations possible.

According to WPB estimates, it will take an average of 1½ tubes per set to put the "silent 9%" of America's receivers back into action. Thus the first million tubes would restore 660,000 sets, where the same number would spread over only 200,000 five-tube, and a smaller number of larger new receivers.

**F**M ALLOCATIONS were fixed between 88 and 106 megacycles by the Federal Communications Commission on June 27. Twenty of these channels, between 88 and 92 megacycles, are reserved for non-commercial educational FM stations.

Six channels are assigned to television, one between 44 and 50 megacycles, three between 54 and 72 and two between 76 and 88. Amateurs will occupy the frequencies between 50 and 54 megacycles allotted to them by the Commission early in the year. This will continue the old "5-meter band" which formerly ran from 56 to 60 megacycles.

The remaining space in the spectrum between 44 and 108 megacycles was allotted as  
(Continued on page 730)



Left—Equipment used in the G-E demonstrations. Below—Making Radiotype tapes.



# Monthly Review

## to the Technician

**T**ELEVISION will appear as an executive force in the postwar world, holding large companies together and permitting a closer-knit management than is now possible, reported International Business Machines last month, announcing its intention of providing television relay facilities on a common carrier basis for business use.

With the help of television, a chain store with branches in all parts of the country could maintain a daily or hourly checkup on receipts, inventories, sales, etc. All the bookkeeping could be handled in a central office. Such organizations as railroads, with their widely-scattered equipment and centralized organization, would also benefit greatly by the use of television.

**F**RANCE will move to present her public with high-definition television at the earliest possible moment, according to a report released last month by International Telegraph and Telephone Co. A cable from their French associate states that the Administration plans to order experimental equipment in 1945, with the object of setting up television standards in about a year.

The French Broadcasting Administration considers that the public will insist on a television service having a quality as comparable as possible to the movies—according to the cablegram—and feels bound to make such service available at the earliest possible moment. Experiments will be made on both 750- and 1,000-line images. Low-power transmitters will be ordered to enable field tests on 150, 600 and 1,500 megacycles. Meanwhile, the pre-war Eiffel-Tower station working on 455 lines with 30 kw peak power will temporarily resume operation in order to build up experience in studio technique which is now lacking.

**A** PHANTOM regiment of radio-men and cryptographers was responsible for the super-efficient communications service which was a determining factor in the invasion of France, a last month's report from Paris reveals.

The mixed British and American complement of the regiment were divided into patrols and accompanied all units, thus making communications from all parts of the front a continuous process and cutting out the traditional delay in movement of information from frontline companies to command headquarters.

Effectiveness of the regiment was increased by the system of coding. This was handled with a special coding machine, invention of a British signal officer. The "coder" scrambled the messages at one end and a duplicate machine unscrambled them at the other. Messages handled through this system were unbreakable, as code symbols were used only once.

The name "Phantom" was no war correspondent's dream. Men of the regiment wore a black patch with a white "P" on their right sleeves. The youngest of all types of regiments, they set a proud record, casualties in the European invasion amounting to over 50% of their total strength.

**D**EALERS interviewed by *McCall's* Magazine expressed opinions differing in many instances from those of the nation's customers, according to a survey whose results were announced last month.

Better radio furniture for the postwar radio is the first requisite for sales, according to the 376 dealers interviewed. The three most popular models will be the table radio, the console combination and the table combination, not necessarily in that order. Dealers saw no future for the console radio without phonograph, and suggested that manufacturers would be well-advised to discontinue the model.

Among console radios, the type in which the record player pulls out was the favorite, with 253 votes out of 329, the remainder of the 376 dealers not voting. The "lift top" was next, with only 40 votes, while the tilting front type and the combination in which the top must be lifted to get at either radio or phonograph split only 36 votes between them.

The question of brand loyalty raised in consumer surveys also appeared among dealers. While the majority stated that they expected to carry the same brand as pre-war, most of them had reservations. It was pointed out that in radio, far more than in other electrical appliances, new names had a habit of springing up and dominating the market for a few years, before giving way to another or fading out entirely.

On only one thing the dealers were in agreement—the assured future of FM.

**M**ULTIPLEX telegraphy, long familiar on wire circuits, will now speed up transmission by radio while cutting errors to the zero level, according to a report released last month by the Radio Corporation of America.

By means of specially designed equipment which employs what is known in the industry as "time division multiplex telegraph" principles, the equipment can handle 488 words per minute inward and outward simultaneously, corresponding to eight channels each way with an individual channel speed of 61 words per minute. The equipment also permits operation of four or two channels instead of eight channels, when desired.

All eight channels may be utilized for two-way communication with one distant station. Alternatively, they may be set up in such a way that four channels with a total capacity of 244 words per minute can be operated in both directions simultaneously between two different stations, with automatic retransmission of one or more of the channels to a third station.

Moreover, printing mechanism incorporated in the system accomplishes the feat of making the circuit virtually error-proof, despite its high speed. Let any letter be mutilated or garbled in transmission and a warning bell rings under the receiving printer. At the same instant, in lieu of the mutilated character, a maltese cross appears to mark the exact spot of the error and facilitate correction. In other words, no error can get through directly to the message blank.

Another bell, of noticeably different pitch, is operated by means of a switch similar to a telephone dial. With it the receiving operator can pass a number of stock phrases for service instruction to the other end of the circuit, thereby saving channel operating time.

The printer is completely automatic and, in conjunction with the multiplex mechanism, the system functions with a minimum

(Continued on page 730)

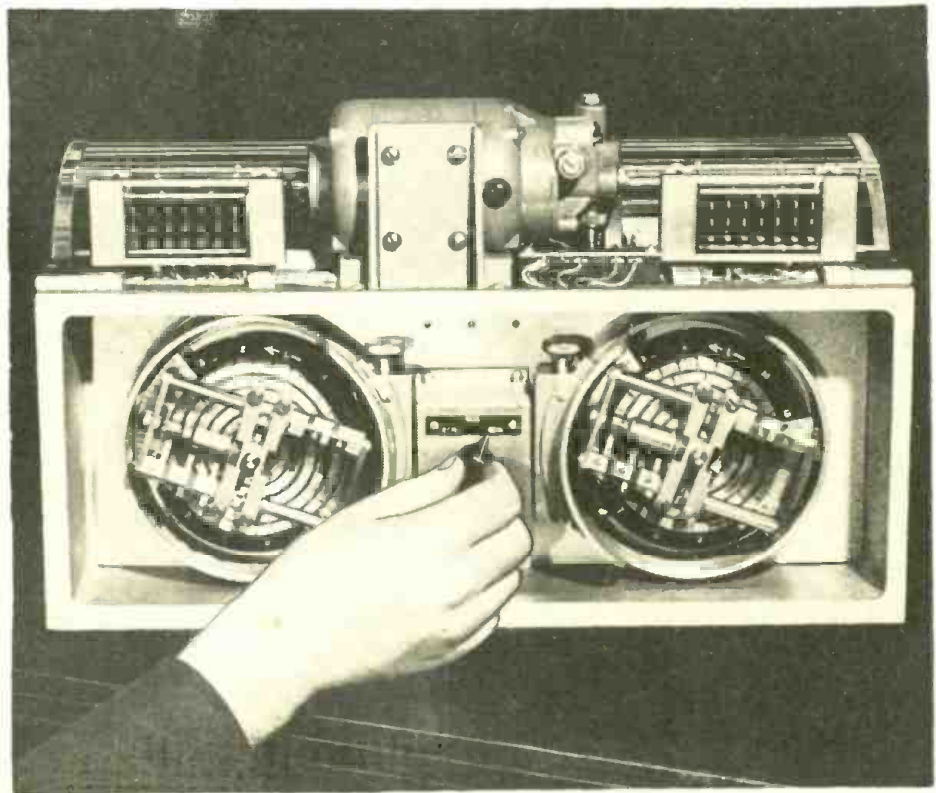

The multiplex distributor used by RCA to transmit over eight channels simultaneously.

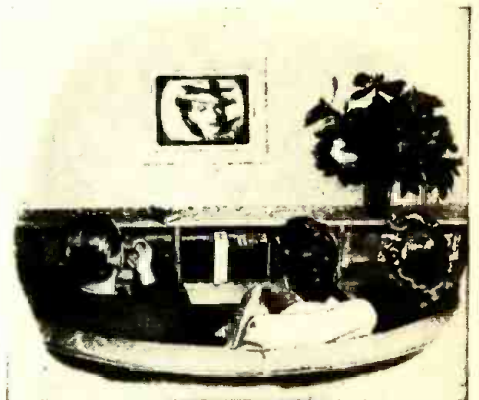
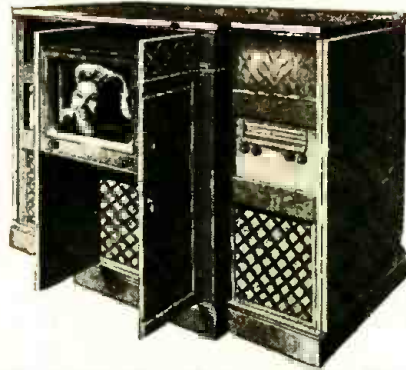

Left—A projection televisior. Center—The retractable direct-viewing tube in a cabinet. Right—Same tube flush-mounted in the wall.

# TELEVISION *and the* SERVICEMAN

By GENE CONKLIN

ONE OUT OF EVERY TEN RADIO SERVICEMEN ARE COMPETENT AT THE PRESENT TIME TO REPAIR OR INSTALL TELEVISION RECEIVERS.

MANY AMERICAN CITIZENS EXPECT TO PURCHASE, NOT ONE TELEVISION RECEIVER FOR THE HOME BUT THREE OR FOUR MODELS, INCLUDING PINT-SIZED EDITIONS FOR BEDROOM AND GUEST ROOM USAGE.

THESE headlines are startling in their implications. Such an excellent job has been accomplished in selling television to the public that, at the end of the present conflict, clamoring for television in

the home will be loud and consistent on the part of the American populace. All of which adds up to the inescapable conclusion that radiomen had better burn the midnight oil NOW in an attempt to master the intricacies of television for home consumption.

Starting point in the discussion of postwar television servicing problems is erection of the television antennae. Basically speaking, the antenna must be light weight and extremely compact. This is especially necessary where residents dwell in crowded apartment houses. In order to assure maximum reception from a number of local television transmitters, it may be necessary to install an array of television antennae, each one in the best position for a local video sender. More to the point, there is the problem of the transmission line which connects the receiver and antennae proper.

The difficulty which exists in regard to the transmission line is that the material of which this line must be composed is relatively expensive. It is necessary to use between 70 and 85 feet of highly-special coaxial cable for this purpose and, at the present moment, the cost to the serviceman is high indeed, with little prospect of a price deduction.

Unfortunately for the radioman, nearby buildings or steel structures cause echoes which impart a ghost-like quality to the televised image. See Figs. 1 and 2. There is no method of eliminating this extremely undesirable trait. More to the point, any metal object on or near the house roof top causes trouble with respect to the quality of the visual image.

From the preceding it can be seen installing a television antenna is a two-man affair. One member of the servicing duct must be parked at the receiver, making continual adjustments, while his partner in crime is constantly changing the antennae to insure as perfect reception as seems possible to obtain. Communication between the duct will probably be handled by a pair of handy-talkies. Not unnaturally this procedure may require hours and the customer will have to pay at an hourly labor rate sufficient to cover the services of both individuals. It can readily be observed that not more than two, or possibly three such installations, can be completed through the course of a service-shop day. All of which leads to the inescapable conclusion that a charge of from \$50.00 to \$80.00 may have to be made for the antennae installation alone.

The next problem on the television serviceman's listing of visual headaches is the question of the size of the image to be received in the home. So far, considerable experimentation with both 12 and 20 inch tubes have not produced too satisfactory results.

It is necessary to mount these tubes vertically, which again makes it imperative to use a mirror. A 64-carat dilemma results because the viewer's eye has to cope with a double image, one from the glass surface itself, and one from the silver. This condition can be partially remedied by utilizing surface silver mirrors but such items are expensive, delicate and tarnish with the greatest of ease.

According to television experimenters,

(Continued on page 727)

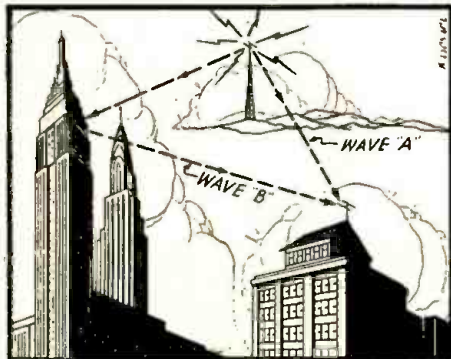
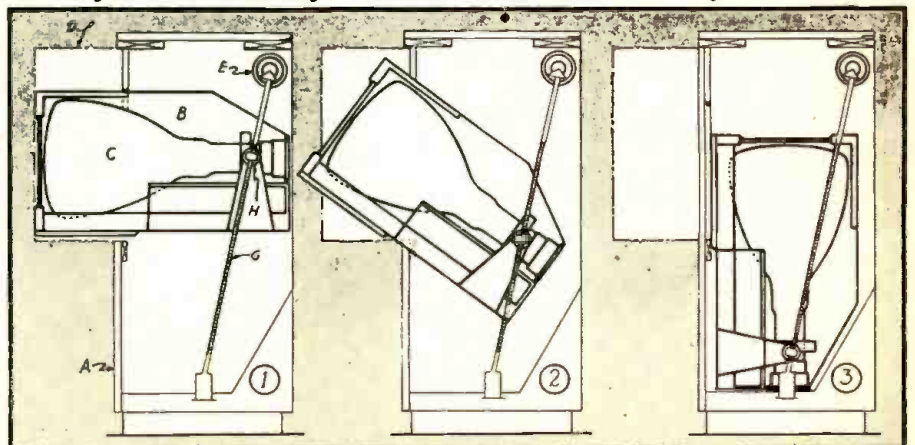
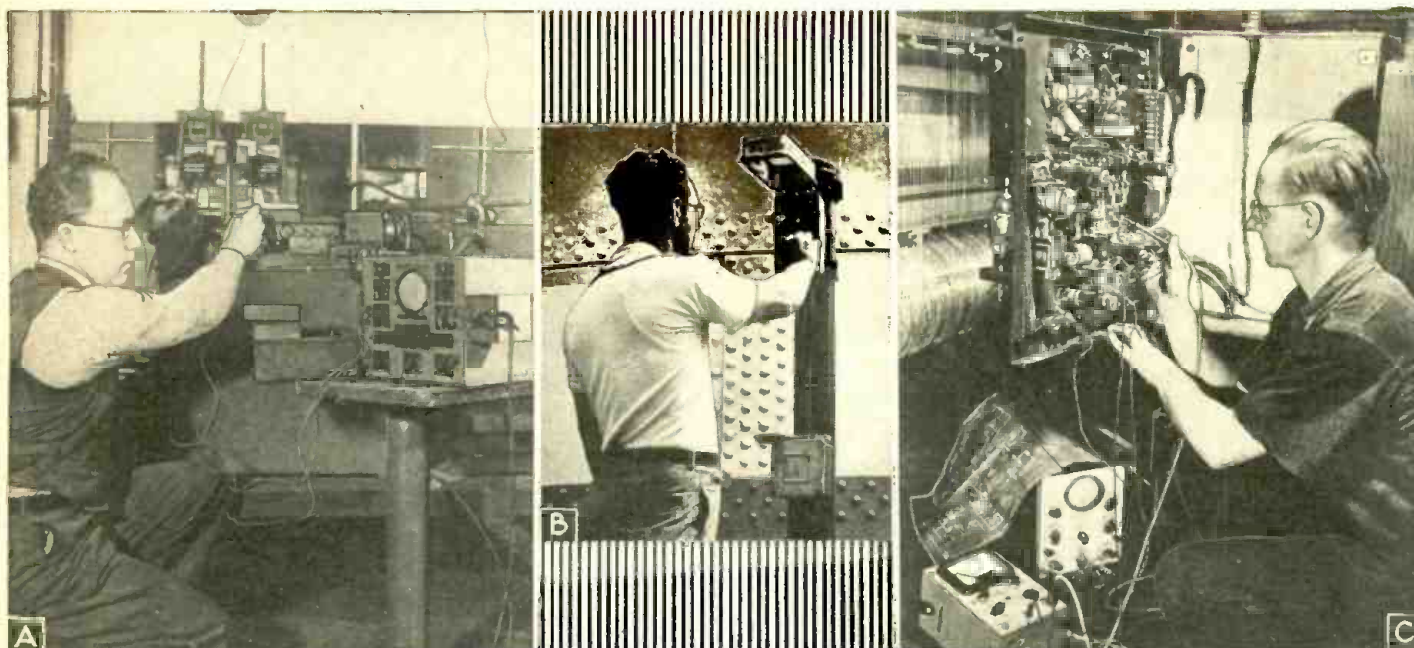

Fig. 1, top—How reflections from buildings or cliffs form a "ghost." Fig. 2, corner—Appearance of a ghost on the screen. Fig. 3—How the DuMont retractable tube goes into its cabinet.







Photos Courtesy General Electric Co.

A—Checking flash-welding machine. B—Operational check on photo electric relay. C—Servicing Thy-mo-trol drive in wire enamelling system.

# FACTORY RADIOMEN

Electronic equipment in the postwar factory will require maintenance. The radio repairman is the logical one for the job.

By E. A. WITTEN

WITH the increase in production of electronic equipment only awaiting the end of hostilities—the radio technician invariably will enter the field of industrial electronics. This branch of the radio industry differs from communication work especially in the type of personnel available for routine servicing. Here lies an opportunity. The industrial electronics field is rapidly expanding, and with the advent of V-J day, will really make strides. The many advances made during the war are a good indication of what can be done, and what will be done. Radar, electronic computing gunsight, dielectric heating, intrusion alarms, magnetic recording and FM are only a few of the many ideas either new or accelerated since that black day in 1941. There are still to be added to that list many ideas that cannot be spoken of—yet.

The range of industrial electronics extends from apparatus similar to standard communications equipment at one end, to the large pumped ignitron and multi-anode tanks rectifying thousands of kilowatts. Even in the best designed equipment, there are always tubes that burn out, leads that break from vibration, and fuses that blow. The most difficult problem the manufacturer faces in the acceptance of electronic control, is the job of servicing and maintenance. In the average industrial plant, according to a leading industrial electronic engineer\*, "there is rarely anyone from the chief engineer or plant electrician on down who had studied any electrical theory, or knew anything about electronics beyond the twist-

ing of the dial of his home radio, until a year or so ago."

The manufacturer who has an ex-ham in his organization is indeed fortunate. If not, he has to go out and hire the services of some local radio man who has studied industrial electronics. At other times, it is necessary for the electrical department's staff to appoint one of their employees a one-man technical staff. He would have to learn through a school, or teach himself, the intricacies of electronics. He must know this in order to know how to service the equipment intelligently. Instruction books furnished with the apparatus have been improved lately, but at present industrial electronics devices are not made in large quantities and the preparation of expensive instruction books cannot be justified if the equipment is to be built at a price at which it can be sold. It will eventually come down to this: The manufacturer of cloth, candy, furniture or even diaper pins will have to employ an electronic technician as part of his permanent staff. The cost of hiring a local radioman for an hour or two whenever his equipment should break down, would be prohibitive in terms of factory man-hours lost. It is far cheaper for the manufacturer to have on his staff a trained trouble-shooter, ready for all emergencies. That does not imply that the particular equipment will break down every day, nor does it intimate that troubles will all be big ones, but it does require the services of the technician to know where the fuse is that has blown, or the tube is defective, or the wire that is broken.

The ordinary devices that one would expect in the average manufacturing plant,

such as precipitators or smoke detectors, photoelectric door openers, or many specialized devices peculiar to that manufacturer's type of work, are fertile fields for the radioman.

The average technician, with a small amount of study of the apparatus and a glance at the schematic, can plunge right in and get the machine working as well as before. Here the fellow that can do a quick job, and a good job, will maintain his position and the prestige of the radio art as a whole.

Now the average radio man has a question to ask. With what type of equipment will I work? What will I have to install and service? In the many factories which compose our American industry he will find four classes of devices. The first includes the various forms of electronic communication equipment, as useful in the plant as elsewhere. In addition, there are three distinct classes of industrial electronic devices covering a wide range of uses.

## INDUSTRIAL COMMUNICATIONS

Electronic communication equipment used in industry is nothing more than the ordinary radio- and audio-frequency apparatus that has been adapted by the industry for its own needs. It includes interphone systems, public address equipment ("plant broadcasters"), and carrier-current operation both for communication and for relaying. Such old friends as the vacuum-tube voltmeter, the oscilloscope, and the signal generator are in constant use here. The applications may be vastly different and in some cases may seem strange and unusual.

The radio service man, working on new and at first unfamiliar units such as precipitators and smoke detectors, finds suddenly they are only the same circuits he has long worked with in the radio shop, but with modified applications. Then it becomes a simple matter to familiarize himself with any modification or version of these. The situation in this case can be reasonably compared to the serviceman who finds himself confronted with a new type of receiving set, television or FM.

(Continued on page 711)

\* W. D. Cockrell, General Electric Co.

PRESENT BOMBING

FUTURE BOMBING

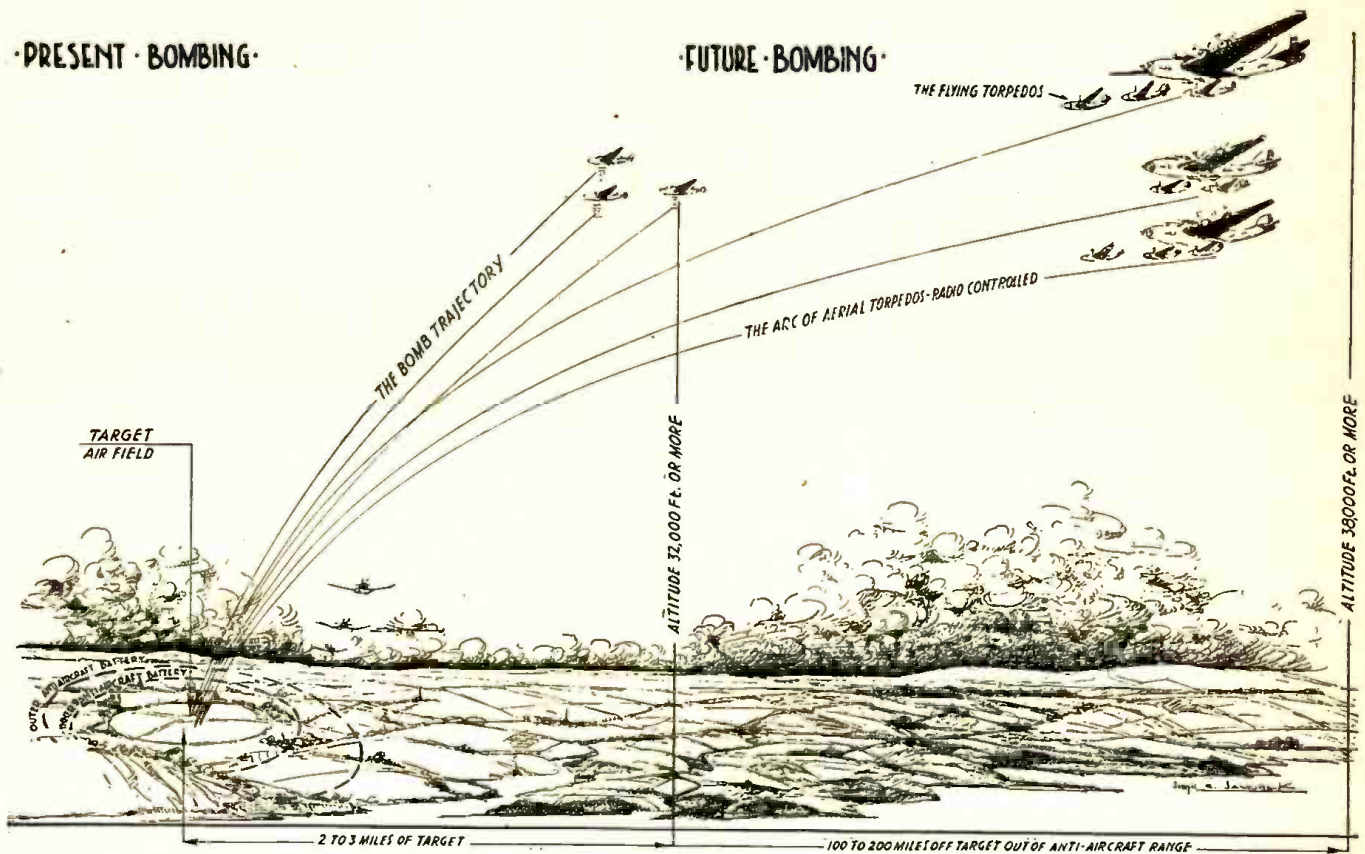

A comparison of present-day short-trajectory bombing methods with future bombing, using long-range radio-controlled aerial torpedoes.

## COVER FEATURE: Radio Robot Plane

ONE of the most startling possibilities in future air warfare appears to be the development of radio-controlled robot airplanes that can accompany heavy, long-range bombers to their distant objectives. Large bombers, despite their numerous gun stations and heavy armament, are always vulnerable to numerically superior and faster enemy fighter aircraft because they are of themselves slower and

By LOUIS BRUCHISS

more cumbersome. Fighter aircraft cannot accompany them on distant missions because their normal fuel capacity is limited.

As part of the bomb load, these huge flying fortresses could each carry a number of tiny radio-controlled planes. These miniature planes would have folding wings so that they could be stowed away in the

fuselage of the larger mother ship, the robot planes being staggered to fit the least possible interference into the faired-away interior. They would have small and inexpensive engines of the required output, fed from fuel tanks of rather small capacity, since their radius and duration of action would be intentionally limited. They will carry a gyro pilot, controlled by robot mechanism set by radio impulses transmitted from the mother plane, as well as several bombs and smoke-screen gas tanks. The bombs could be detonated by radio.

In no branch of aerial warfare has there been any weapon exhibiting the versatile possibilities that these radio robot planes incorporate. They could be hung upon special hooks within the fuselage and the crew could lower them through the fuselage doors, open and lock the wings, start the engine, check the radio control, and release them for free but controlled flight within the visual range of the radio control operators. Carrying their timeable bomb load, they could be directed into formations of enemy aircraft to create havoc among them, and divert and prevent attacks upon the bombers themselves. They could be sent into enemy ground objectives with more accuracy and with less danger to the bombers than any precision-aimed free bomb drops. They

(Continued on page 733)

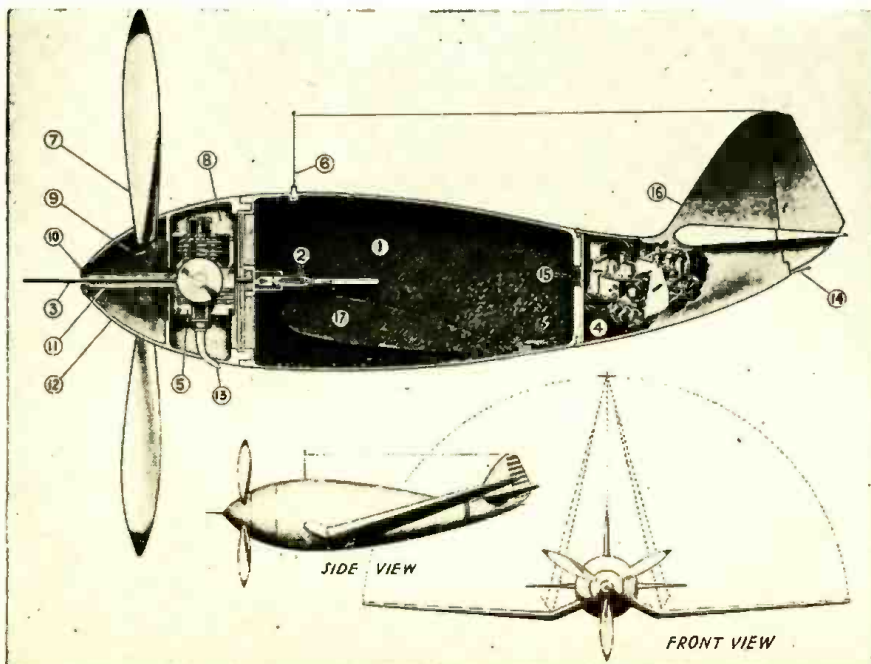

### CONSTRUCTION OF RADIO TORPEDO

- 1—High explosive charge. 2—Detonator and fuse. 3—Firing pin. 4—Radio control space.
- 5—High-powered gas engine. 6—Radio aerial.
- 7—3-blade propeller. 8—Gas tank. 9—Gear.
- 10—Propeller hub. 11—Shaft. 12—Propeller head. 13—Exhaust pipe. 14—Rear antenna.
- 15—Filling plug. 16—Tail. 17—Wing.

# New Ideas In RECEIVERS

By FRED SHUNAMAN

THREE revolutionary new receivers are ready for the postwar world. Each of these will use combinations of principles not heretofore employed in radio reception, and will achieve results not attained in pre-war receivers. One of these new radios will be of special interest to the broadcast listener who prefers easy pushbutton tuning. The second will make its appeal mainly to the long-and-short-wave listener and the third to the commercial operator. All contain ideas demanding the attention of postwar set designers.

Pushbutton tuning problems were attacked by John D. Reid, Jr., designer of the first receiver, photographs of which are seen on this page. It was developed for the Crosley Corporation, and after being kept "on ice" a couple of years, was described and demonstrated at last winter's I.R.E. meeting at New York.

One button is required for each station in present pushbutton receivers. As stations are distributed at 10-Kc intervals from 550 to 1600 Kc, more than a hundred buttons would be required to tune them all. This is impractical, so the usual receiver has a half-dozen buttons to tune in "favorite" stations, and depends on dial tuning for the rest.

The Reid superheterodyne has twenty buttons, in two sets of ten, with which all the stations in the band can be tuned in. The first set of ten buttons sets the antenna input circuit roughly in the middle of a band 100 Kc wide, the ten steps covering from 500 to 1500 Kc, while its oscillator circuit produces not one, but a band of intermediate frequencies 100 Kc wide, covering all the stations in any one 100-Kc step. The second set of buttons covers 100 Kc in 10-Kc steps. To receive a station on 650 Kc, it is therefore necessary to press button 5 in the first row and 6 in the second row. (See Fig. 1). For a station at 1150, buttons 11 and 5 would be pressed.

## A DOUBLE SUPERHETERODYNE

This action requires two successive superheterodyne circuits. The first oscillator ranges from 4600 to 5600 Kc in 100-Kc steps. A broadly-tuned I.F. circuit permits a 100-Kc band of frequencies to pass with approximately constant amplitude.

A unique feature distinguishes this superheterodyne from any hitherto produced. Not one, but a number of intermediate frequencies are passed through the first I.F. to the second mixer circuit. If the I.F. for a 650-Kc station is 4050 (4700 - 650) that for 640 Kc would be 4060, and for a 660-Kc broadcaster, 4040. Each of the allotted frequencies between 600 and 700 beats with

the 4700-Kc oscillator to produce I.F.'s from 4010 to 4100, in 10-Kc steps. The 100-Kc I.F. transformers pass all these signals to the second mixer circuit at substantially the same level.

The second oscillator is variable in 10-Kc steps. It is tuned from 4210 to 4300 Kc with its ten pushbuttons. A frequency can thus be selected which will produce a 10-Kc beat with any one of the ten I.F. signals coming through on the 100-Kc channel. The second I.F. circuits are tuned to 200 Kc with a sharpness dependent only on the degree of fidelity required, and the signal is then fed to a conventional detector and audio system. For the 650-Kc signal, which would come through the first I.F. channel at 4050 Kc, the second oscillator would be set at 4250 to produce the second I.F. at 200 Kc.

As may be seen from the block diagram, Fig. 1, the oscillator buttons are ganged with the input tuning circuits. When a button in the first row is pressed, a tap on the large inductance (see photograph) tunes the set roughly into the correct hundred-kilocycle range. Each button in the second row controls a small trimmer capacitor to bring the input circuit to exactly the frequency of the station being received.

An interesting point is that the ganged controls on the second section work in opposite directions. This is due to the inverting effect of a first oscillator frequency higher than the fundamental. Since the I.F.'s produced by the 4700-Kc oscillator frequency range from 4010 at 690 to 4100 at 600 Kc, the second oscillator has to be tuned 10 Kc lower for each ten-kilocycle increase in the received signal. At the same time the input circuit is tuned 10 Kc higher by the trimmer condensers across the primary inductance.

Since 21 oscillator adjustments must be made, there is a considerable alignment problem. Crystal control would obviate this. A crystal circuit for the receiver has been worked out by Mr. A. A. Leonard of North American Philips, but so far has not been tried in practise.

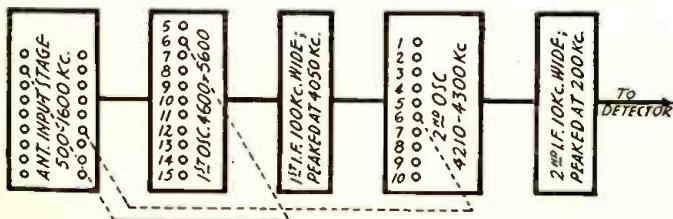
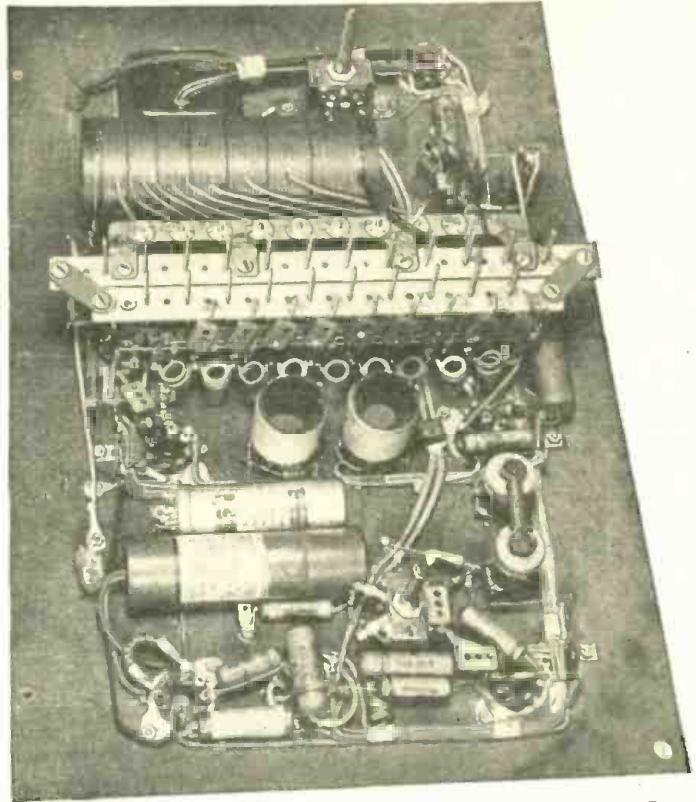

Fig. 1, left—Block diagram of the radio. Buttons are set for 650 Kc, as indicated by the dashed lines.

Right—A front view of the new receiver.



Photos courtesy the Crosley Corp.

Under-chassis view of the double superheterodyne receiver.

The oscillator and intermediate frequencies are chosen to eliminate many troubles of the standard superhet. The high first I.F. discourages image interference. The two oscillator ranges are selected to avoid interfering beats or harmonics. By making the first I.F. at least twice the highest frequency to be received, and the second I.F. less than half the lowest, spurious beats with broadcast stations are also eliminated. These precautions cut out the "birdies" which are a source of trouble in many superhets, and result in a very quiet receiver.

Another factor makes for a trouble-free set. Since the input and output circuits of all the high-frequency stages are tuned to

(Continued on page 722)

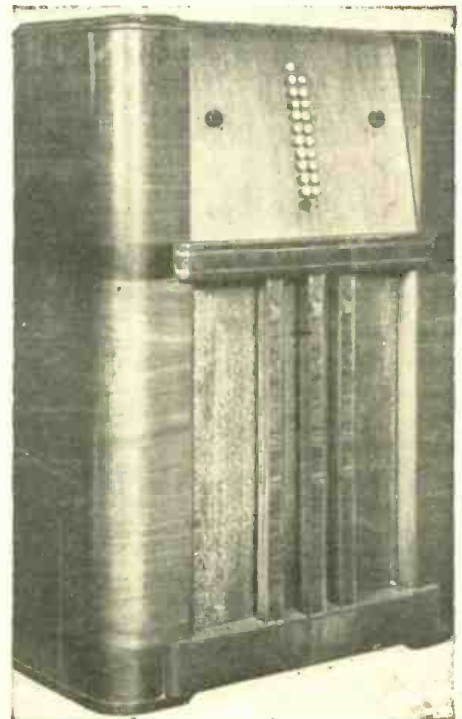

# NEW AUTOMATIC RADIO COMPASS

By J. M. LEE and FRED W. HEDEN

AS the curtain of censorship is lifted on the radio and electronic equipment responsible for much of our success in this war, it will be a little difficult for many to realize that most of these instruments were developed in comparatively short periods of time.

One of these instruments is the Fairchild SCR-269-F, which in its early stages was the first aerial radio compass to operate from the storage battery of a plane. An indispensable navigation instrument in the Army's B-26s and the PBM Martin Flying Boats, this automatic radio compass is adaptable to almost any type of plane. As a matter of fact, probably not one of our bombers or transport planes leaves its base without two of these radio compasses installed.

The equipment is basically a radio receiver, requiring 17 tubes, and using a superheterodyne circuit with additional circuits necessary for radio compass operation. The radio covers a frequency range of

200 to 1750 Kc, with three bands calibrated in kilocycles as follows: Band 1: 200 to 410 Kc; Band 2: 410 to 850 Kc; Band 3, 850 to 1750 Kc.

Designed for remote control operation, the SCR-269-F allows for dual or single control operation. Two remote controls are provided for dual control installations and, although only one remote control functions at a time, control may be readily switched from one to the other. No switching is necessary in one-remote-control installations, since the one radio control box has control at all times.

Optimum performance is provided with a non-directional antenna of approximately 0.25-meter effective height and 50- $\mu$ f capacitance. However, the non-directional antenna size is not critical, and satisfactory operation is possible over a wide range of sizes. Vertical rod antennas and T-type wire antennas supported by stub masts have also proved satisfactory.

With a suitable non-directional (vertical) antenna, one or two headsets, a 14- or 28-volt direct current supply, a 115-volt 400 cycle power supply, and necessary interconnecting wiring, this aerial radio compass is a complete unit capable of providing: (a) automatic bearing indication of the direction of arrival of radio frequency energy, and simultaneous aural reception of modulated or unmodulated radio-frequency energy using a non-directional antenna; (c) aural reception of modulated or unmodulated radio-frequency energy using a loop antenna; and (d) aural-null directional indications of the arrival of modulated or unmodulated radio frequency energy using a loop antenna.

The circuit (shown in Fig. 1) consists of a low-impedance loop, LP-21-F; a tuned stage of loop amplification; means of shifting the phase of the loop amplifier output through 90 degrees (phaser); a balanced modulator circuit which is coupled to the receiver antenna stage; a 48-cycle audio oscillator for modulation of the loop voltages; two tuned RF amplifier stages; a mixer; an RF oscillator; two 142.5-Kc intermediate-frequency amplifier stages; a stage combining the functions of 2nd detector, AVC, and 1st audio amplifier; an audio output amplifier; a compass output amplifier which is tuned to 48 cycles per second, the compass modulating frequency; a diode suppressor circuit which limits the compass output voltage to the loop director circuit with negative pulses from the audio oscillator circuit; and two switching tubes (loop control) which direct the rotation of the loop in response to the phase relation

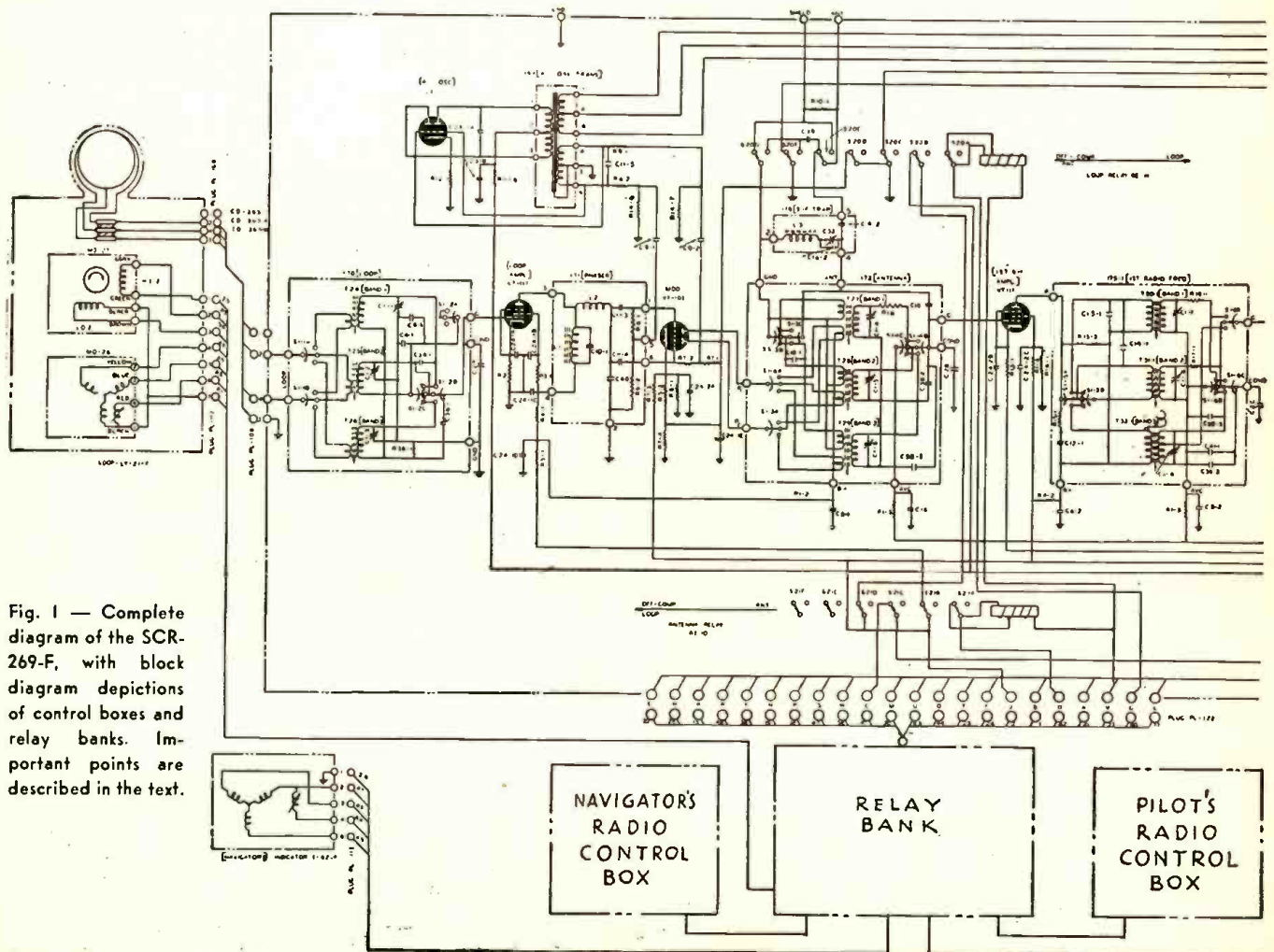

Fig. 1 — Complete diagram of the SCR-269-F, with block diagram depictions of control boxes and relay banks. Important points are described in the text.

existing between the compass output voltage and the negative pulses supplied by the audio oscillator rectifier.

Control of the entire equipment is effected at the radio control box (BC-434-F). The controlling position in dual control installations depends upon the position of a relay (BK-22-F) which switches control from one box to the other. Two primary power sources are required for the operation of this equipment: a 14- or 28-volt D.C. supply for operation of the ON-OFF relay and control circuits; and a 400-cycle per second, 115-volt A.C. supply to provide operating power for the balance of the equipment.

A series-tuned trap (IF) in the input circuits of the antenna stage insures high IF-rejection. Two tuned R.F. stages will give uniform AVC action and good selectivity.

In order to reduce noise when the band-switch motor is operated, a relay (RE-6) is employed. Its circuit is such that, as soon as the band-change switch is operated, the audio output is shorted completely while the motor is running. Another relay (RE-12), operated by grounding a binding post on the receiver panel, is used for providing a connection between a winding on the power transformer and the second I.F. tube suppressor grid to provide aural reception of CW signals.

Since there is a sufficient amount of 400-cycle component in this circuit, the signal in the second IF tube may be modulated by this frequency to produce a tone in the headphones for CW reception. In addition to the binding post on the front panel, a  
(Continued on page 738)

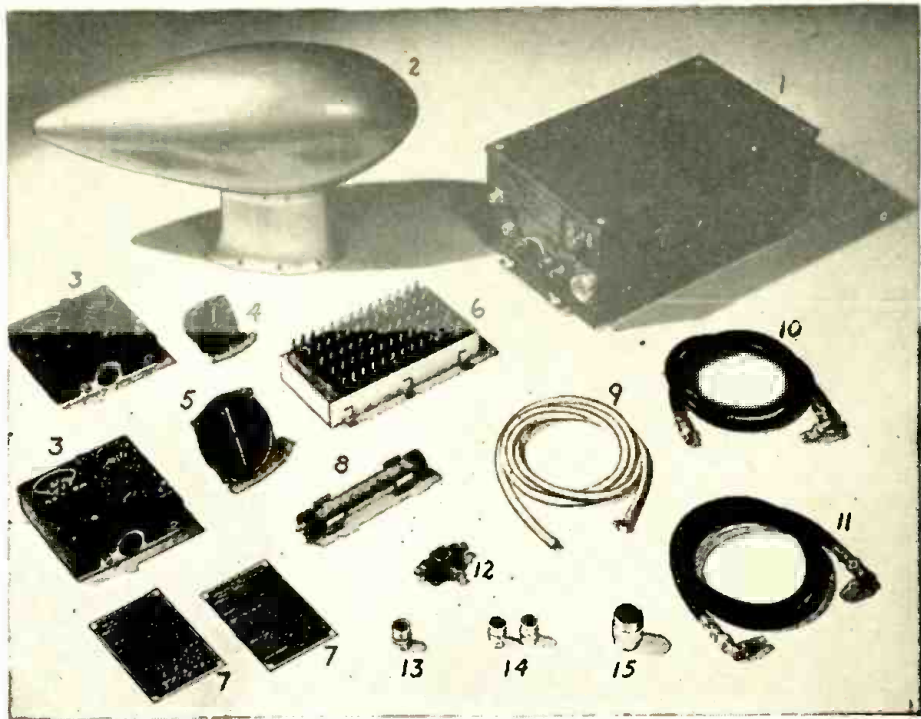

Components of the three-band automatic aerial radio compass. 1—Loop (includes housing and mounting). 2—Radio compass unit. 3—Control boxes (two for dual operation, identical). 4—Pilot's indicator. 5—Navigator's indicator. 6—Relay. 7—Charts (two for dual operation). 8—Loop dehydrator. 9—Dehydrator base. 10—Cord. 11—Cord with two conduit elbows. 12—Coupling. 13—Plug (loop power circuits to connector panel). 14—Plug (one for each bearing indicator to connector panel). 15—Plug (compass unit to connector panel).

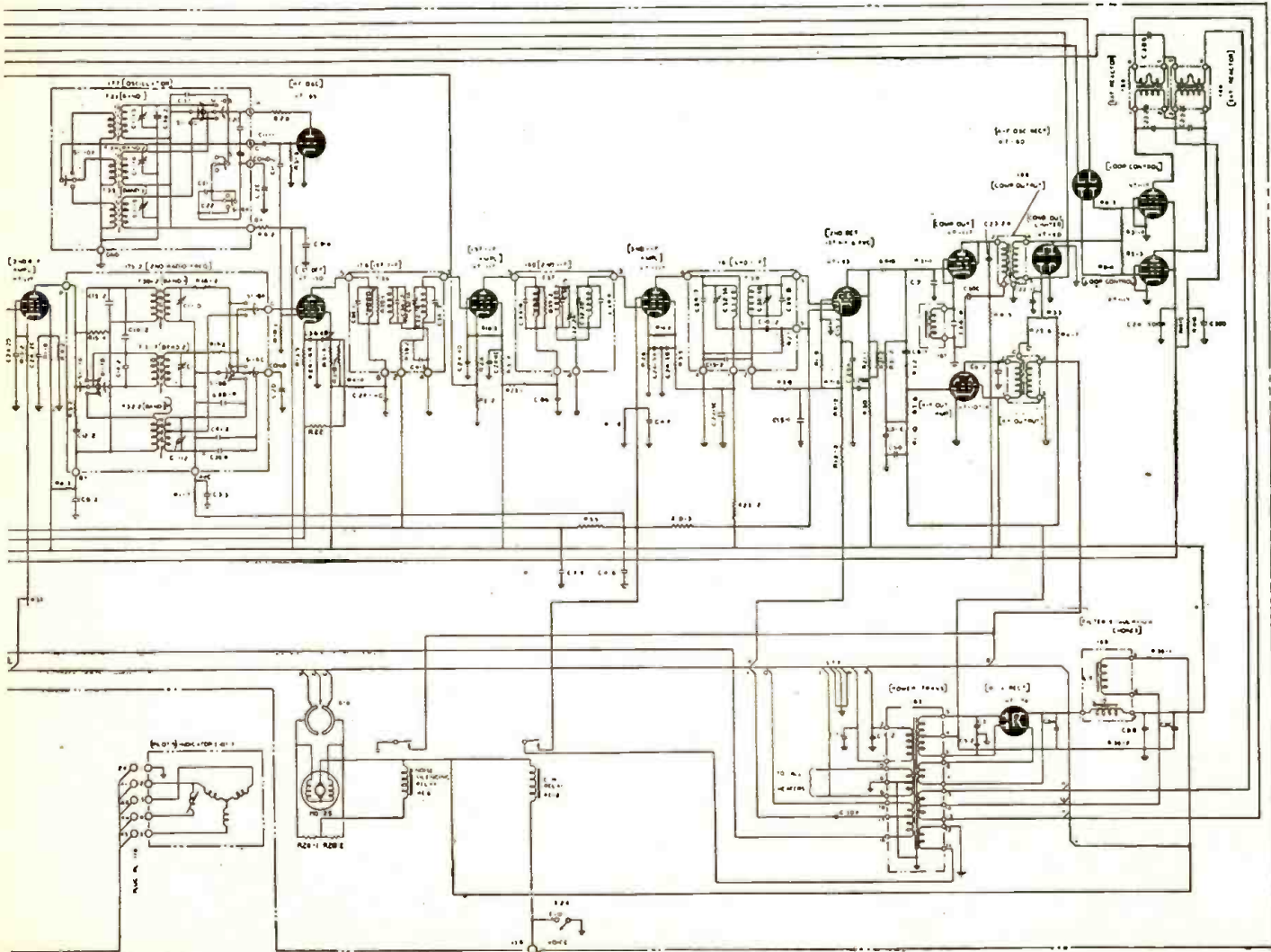

# MICROWAVES

## PART II—GENERATION OF MICROWAVES

By CAPTAIN EUGENE F. SKINNER\*

**F**UNDAMENTALS governing the use of microwaves, and operation and applications of the Klystron have been presented in previous articles. In addition to Klystron tubes, there are other types of tubes and circuits which are used at microwave frequencies. Two of the most important are the Barkhausen-Kurz circuits and the Magnetron circuits.

While the Barkhausen-Kurz oscillator is largely an experimental one and is not widely used in actual microwave applications, it is as basic a circuit for microwaves as the Hartley oscillator is for ordinary frequencies, and an understanding of how it works will give the amateur and the experimenter a better background for their work.

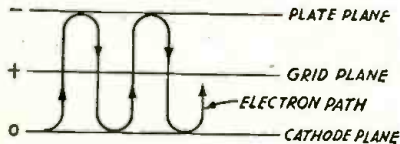

Fig. 1—Electron paths in a B-K oscillator.

Barkhausen and Kurz discovered a new type of oscillator in 1920. It is also known as the B-K, retarding field, or positive-grid oscillator. This type of oscillator has been used to generate ultra-high frequencies and microwaves up to a few centimeters in length, and works on principles which are relatively simple when considered qualitatively. Exact mathematical treatment is very difficult and does not lend itself to a better understanding of the operation of the tube, so will not be touched on here.

Basically the tube itself consists of a single straight wire filament surrounded by a cylindrical grill and plate. The grid may be of parallel wires, or it may be of a number of wires twisted into a helical shape. The

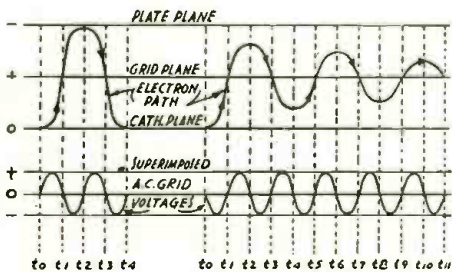

Fig. 2-a, left—Electron path, grid going positive. 2-b—Same, grid going negative.

plate itself is merely a cylindrical tube. This tube is a triode with the elements specially arranged.

For producing oscillations in this type of tube, the grid is positive instead of negative. The plate, instead of being positive, is usually slightly more negative than the filament, but may be at the same potential. Electrons from the filament are accelerated toward the grid by its positive potential, most of them passing through the meshes, and entering the field between the grid and the plate, where they, being negative, are repelled by the negative or relatively nega-

tive plate. They stop, reverse direction, and then accelerate back toward the positive grid, which attracts them. Again, most of them pass through the grid, enter the field between the filament and grid, where they are again repelled, this time by the filament itself. They stop, and together with the new electrons which are leaving the filament at that instant, start toward, then through the grid again. Each time that the electrons pass through the grid, some of them are lost to it. Those which continue to oscillate back and forth return to the grid each successive time with lower energy, and move a shorter distance away from it. Eventually the electron strikes the grid and is lost. This grid operates at a high temperature, and necessarily has to withstand high power dissipation. Grid failure is the most common cause of failure of this type of tube. The path of the average electron is shown in Fig. 1.

If an A.C. voltage that has a period approximately equal to the electron transit time from the cathode to the plate is superimposed on the positive grid source, it is possible to either extract energy from the D.C. source, or give energy to it. Figs. 2-a and

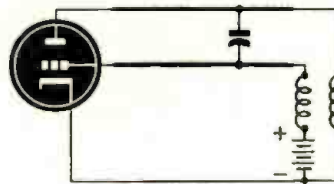

Fig. 3—Complete Barkhausen-Kurz circuit.

2-b show typical paths of electrons for two conditions: Fig. 2-a shows an average path when the electrons start from the filament at an instant that the applied A.C. on the grid is going positive, therefore making the grid more positive than it normally would be, and Fig. 2-b shows an average path when the electrons start from the filament at which this applied voltage is going negative.

If the grid is more positive than normal, the electron is sped up. As the electron approaches the plate, the A.C. voltage on the grid reverses, and the grid is less negative, causing the electron to slow down less on its return trip. In a trip like this, it is possible that the electron will strike the plate, but if it does not, it returns to the grid or cathode. As the electron has been sped up during its entire trip, it returns to the cathode with an appreciably increased velocity, and the energy with which it strikes the cathode must have been obtained from the A.C. source applied to the grid. If the electron starts a trip when the A.C. voltage is decreasing, the electron is constantly slowed down rather than sped up, and after making several decreasing oscillations, it comes to rest on the grid. In this case, energy is given up to the A.C. source rather than taken from it. Electrons will be leaving the filament during every instant of the cycle of the A.C. voltage, but as the energy taken from the A.C. source during one-half cycle is approximately equal to the energy given up to the A.C. source

during the first "trip" of the electrons during the second-half of the cycle, and these latter electrons make several trips, giving up energy during each, there is a net gain of energy by the A.C. source on the grid.

It has been shown theoretically how D.C. energy can be converted into A.C. energy. Since the requirement for sustaining oscillations is that more energy be given to the tuned circuit than is taken from it, a tuned circuit may be connected to this triode between the grid and plate. Oscillations down to about ten centimeters wave length may be obtained, but generally the efficiency is very low, and the maximum power output is about 10 watts. Figure 3 shows a circuit of the type described. Similar oscillator

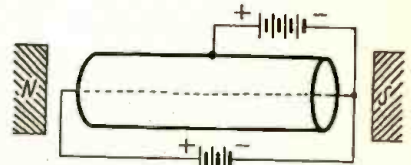

Fig. 4—Magnetron oscillator, basic circuit.

circuits may be obtained by connecting the tuned circuit between the grid and cathode or the plate and cathode. In constructing this circuit the external circuit should be a Lecher-wire system plus the other components shown in the circuit diagram. This makes it very simple for the experimenter, as the only component that he needs that he cannot easily construct is the tube. In fact, the B-K circuits are the only ones he can work with at present. Fairly high frequencies can be obtained with certain types of standard triodes having cylindrical grids and plates, in purely experimental circuits where power output is not a consideration. Other microwave circuits depend on special tubes which will not be obtainable by the civilian experimenter for some time.

As the condenser shown in Figure 3 is moved along the two parallel wires from the tube, the wave length of the oscillations will slowly increase, suddenly drop, then increase again. This is known as the Gill-Morell effect, and shows that the external circuit obviously influences the oscillations inside the tube.

Probably the most important type of tube in present-day microwave applications is the magnetron. Basically, the magnetron consists of a plate in the form of a cylinder, a filament that runs axially through the cylindrical plate, and the poles of a strong mag-

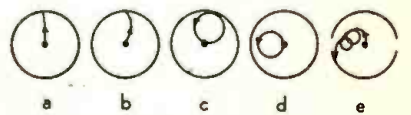

Fig. 5—Electron paths in a magnetron tube.

net so placed that the lines of magnetic force also run axially through the cylinder, as shown in Figure 4. With no magnetic field, the electrons travel from the filament to the plate without interference, but when a magnetic field is applied, these paths become curved, increasing in curvature with the increasing magnetic strength, until a cutoff point is reached. At this point, the electrons just graze the cylinder, and return to the cathode. With a still greater increase in magnetic field, the electrons travel a much shorter path, and miss the cathode completely.

At the cutoff point, the plate current drops to practically zero, and past cutoff point, it does become zero. Typical electron paths are shown in Fig. 5. Most often in practical applications the plate is split into two or more segments as shown in Fig. 6. In this type of circuit the tuned circuit be-

(Continued on page 725)

\*Hq. AAF, Office Asst. Chief of Air Staff, Training Aids Division.

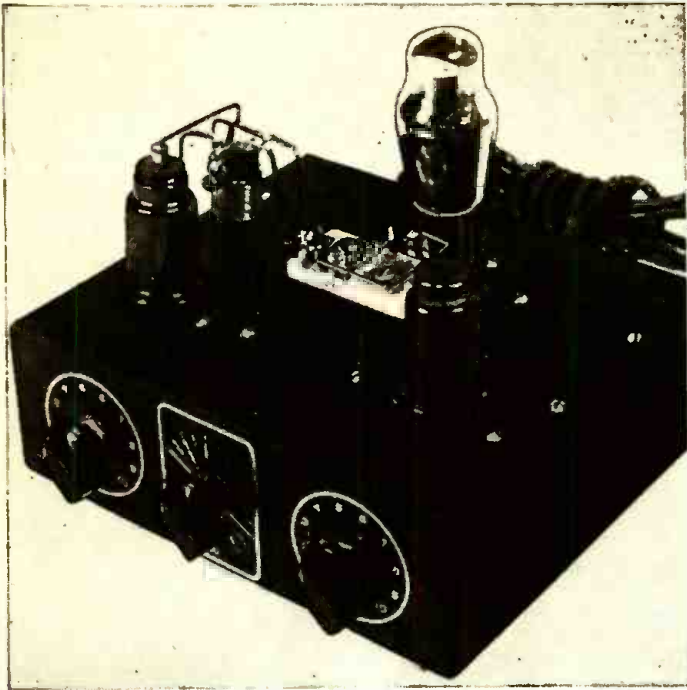

Electronic Metronome. Tuning condensers are the trimmers in center of chassis.

An under-chassis view of the instrument. Control in center is the D. P. D. T. switch. Terminal strips help make a systematic layout and a neat wiring job.

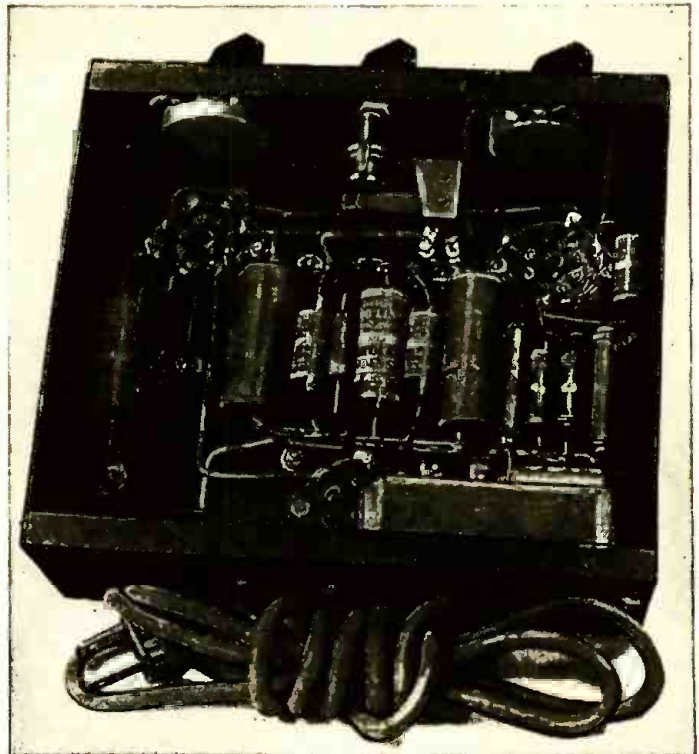

# ELECTRONIC METRONOME

By C. C. GRAY

THIS electronic metronome will be found very handy for all students of music, especially now when it is almost impossible to buy an ordinary metronome. It works on the principle of the multivibrator, in that it distorts the wave shape to produce a multitude of harmonics.

A multivibrator is essentially a two-stage resistance-coupled audio amplifier with the second stage coupled back to the first. By

natural discharge rate of the resistor-condenser combinations, and if necessary can be calculated by the formula:  $1/(R_g C + R'g C')$  cycles per second.  $R_g$ ,  $C$ , and  $R'g$  and  $C'$  are the blocking condensers and grid resistors of the first and second tubes respectively.

The 6J7 is connected also as an ordinary grid-tickler type radio-frequency oscillator, with one exception. The lower end of the grid coil returns to ground through a high resistance. When, as part of the multivibrator, the 6J7 is conducting, it oscillates at a broadcast frequency, determined by  $L_1$  and  $C_1$ . Pulses of R.F. are thus sent out at the multivibrator frequency.

The coil  $L_1$ ,  $L_2$  is an ordinary broadcast antenna coil; the low-impedance aerial winding is  $L_2$ , the grid-tickler winding. If this type of coil is unobtainable, you can wind your own, on a coil form  $1\frac{1}{2}$  inches in diameter. Wind 90 to 110 turns of No. 28 wire on this. The grid-tickler is composed of fifteen to twenty turns of No. 30 or 32 wire. This should function satisfactorily with the two trimmer condensers in parallel, which serve as the tuning condenser,  $C_1$ , for the R.F. oscillator. No antenna

is necessary, as there is sufficient radiation from this coil.

The multi-vibrator frequency range is much greater than can be obtained with a metronome. With the values shown in the schematic (Fig. 2) it is possible to obtain a beat as slow as twenty per minute. By switching in the .01 condensers, the complete audio spectrum can be covered.

When the .01 condensers are thrown in the circuit, you have a code practice oscillator that is different. A key can be inserted between the cathode and ground, and any desired tone can be obtained by varying the 3-megohm potentiometer.

Any suitable type tubes can be used in place of the 6J7 and 6C5. A 6A7 would be particularly suitable, as you can use the plate and the No. 4 grid as the R.F. oscillator and the No. 1 grid for the multivibrator control. A type 76 works very nicely in conjunction with a 6A7.

Operation of the metronome is simple. Just turn it on, tune it on your radio like a wireless phono oscillator, adjust it to the desired beat, and your radio will click out the

(Continued on page 732)

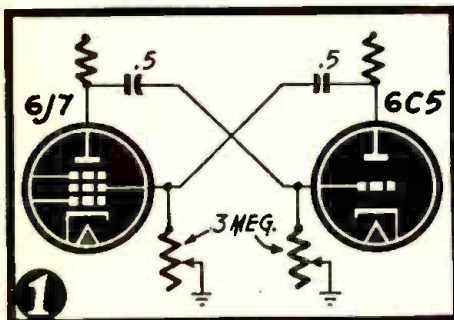

Fig. 1—Fundamental Circuit of the device.

varying the size of the coupling condensers and grid resistors, oscillations—varying in frequency from the supersonic range to one or so per minute—can be produced. This instrument is so constructed that two frequency ranges are available, one in the range required for a metronome; the other suitable for a code practise oscillator.

The principle may be easily understood from Fig. 1. On the metronome range, audio output from the 6J7 is fed to the 6C5 grid. The 6C5 output is fed through a 0.5 mfd. coupling condenser back to the 6J7 grid through a condenser of equal size.

Variable 3-megohm grid resistors are provided. The frequency depends on the

Fig. 2—The metronome includes a multivibrator and an oscillator. It can be adjusted for widely different frequencies and even acts as a code oscillator. For higher frequencies, the 0.1 condensers may be replaced by smaller (.01) units.

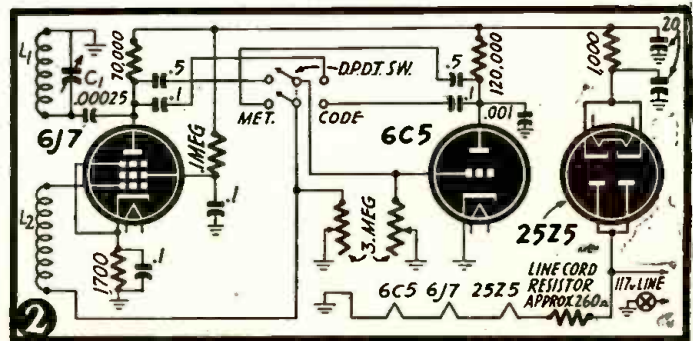

# Parasitic Oscillations

## PART II—GETTING RID OF THE SQUEALS

By STAFF SGT. DEAN STOCKETT EDMONDS, JR.

HAVING determined the size of the set, the number of stages, and the tubes, we may now approach directly the problem of keeping parasitics out of these stages. We have described what form these parasitics take—a stage or a cascade of stages on one frequency acting as a tuned-plate-tuned grid oscillator because of the presence of sufficient feedback. Such oscillation is termed parasitic because it uses power supplied to the tubes for amplifying purposes to generate a spurious signal.

Throughout this article mention has been made of feedback paths and of specific in-

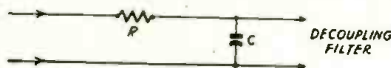

Fig. 2—Simplest type of decoupling filter.

formation on their elimination. It is now time to see exactly where these feedback paths lie and what circuits and construction methods are effective in breaking them up. Any amateur who has read considerably in an attempt to find a cure for his oscillating receiver is familiar with the usual suggestions: keep the hot R.F. and ground leads short; keep the wiring close to the chassis; and use plenty of shielding. Some designers admit that shielding is not the panacea for all parasitic troubles, but most fail to describe other cures. Let it be said here that short leads are absolutely essential for proper operation and stability, and the chassis layout should be made with this idea foremost in the designer's mind. Keeping wiring close to the chassis is a good idea, although not essential for parasitic elimination, and the right amount of the right kind of shielding is very necessary. But there are three outstanding points that determine the freedom of an R.F. or I.F. amplifier from parasitics and that excel all others in importance. These are the actual design of the stage, the placement of the parts and the grounding.

Looking first at the problem of design, it is necessary to understand what may constitute a feedback path before circuits may be drawn up to disrupt such paths.

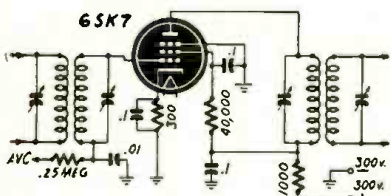

Fig. 3—Stable intermediate frequency stage.

Here we find that R.F. can find its way along almost anything. Any circuit which is common to more than one stage, even though it is supposed to be at ground potential for R.F. and as such is heavily by-passed, is a potential feedback path. Thus common screen-supply circuits, the "B" supply, the A.V.C. line, and even the chassis itself may be R.F. carriers, even though theoretically all R.F. is shorted out of them and it may be almost impossible

to detect any at these places with meters.

Since meters and calculations are of little use (unless the scope of the average experimenter is far exceeded) in determining where a feedback path or paths may lie, the only solution is to regard every conducting line common to any two or more stages (including the chassis) as an R.F. coupling between those stages and to treat it as such.

The first step in receiver design then should be obvious—as few circuits as possible should be made common to two or more stages. The A.V.C. and "B+" lines, and of course the chassis, will have to remain common circuits and be dealt with accordingly. Such atrocities as common screen supply circuits (often used to save a few resistors and condensers) are totally unnecessary and can contribute an unbelievable amount towards parasitic troubles. Receivers that display a hopeless condition of self-oscillation have been cured almost magically by getting rid of the common screen supply and substituting individual dropping resistors and by-pass condensers for each tube. It should be possible to eliminate all circuits common to several tubes except those mentioned above—the A.V.C. line, the "B+" line, and the chassis. The latter can be dealt with by proper grounding of circuit elements to it and

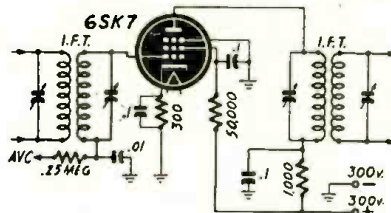

Fig. 4—An improved screen resistor circuit.

actually grounding it as directly as possible.

Where a short, low resistance connection to earth is impossible, a .01 mfd. paper condenser connected from the chassis to the power line will usually be of great help, and may prove downright essential in A.C.-D.C. sets. In the latter case, if one side of the power line is connected directly to the chassis, a paper condenser from the "hot" side of the line to the chassis will usually be necessary to eliminate signals entering the receiver through the line, since in these sets the isolation that a power transformer provides is absent. As to the "B+" and "A.V.C." lines, by-passing both lines by paper condensers is essential (the electrolytics in the power supply are not good R.F. by-passes and should on no account be relied on to by-pass the "B+" line for R.F.), but successful prevention of their operating as R.F. feedback paths depends on individual decoupling from them into each stage. We may take an I.F. stage as an example and show how filters may be applied.

A decoupling filter consists basically of a resistor in series with the line followed by a by-pass condenser. Time constant of this RC combination depends directly on the values of R and C (Fig. 2) and

may therefore be chosen to reject all signals above a given frequency. Since the A.V.C. and B+ lines are D.C. lines and any A.C. component present on them is unwanted, theoretically the R and C of decoupling filters in these circuits could be infinitely large, but they are limited by practical considerations. In the first place, a resistor in series with the "B+" to a tube drops the voltage to that tube, which we don't want. Paper condensers are bulky,

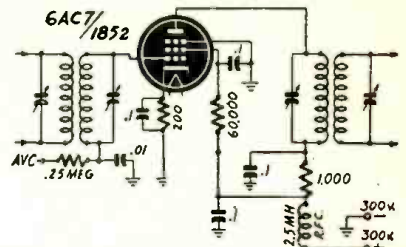

Fig. 5—The 6AC7 works well in this circuit.

so there is a physical limitation there. Voltage regulation in the A.V.C. line is so poor that the leakage in a large condenser—even one of the paper type—may cause intolerable loss in A.V.C. voltage. Moreover, the time constant must be short enough that the grid of the tube involved will follow changes in signal strength without excessive lag. A combination which has proven itself foolproof in a variety of stages as the A.V.C. decoupling filter is a 250,000 ohm resistor followed by a .01 paper by-pass.

The cathode circuit of our parasitic-proof stage may follow the same pattern as that of any conventional I.F. or R.F. amplifier. Cathode bias, by means of the usual cathode resistor and by-pass condenser, is a time-tried circuit and is to be highly recommended, since with this arrangement bias tends to adjust itself automatically to optimum for the existing conditions. We should bias only up to the optimum operating conditions of the tube. Any additional operating bias serves only to reduce the gain. For the 6K7-6SK7 class, 300 ohms is about right, while 200 ohms is correct for the high-transconductance types. A .1 mfd. paper by-pass condenser should be used.

In determining the screen dropping resistor for an R.F. or I.F. amplifier, we may choose from a considerable range—30,000 to 60,000 ohms, approximately. This resistor not only serves as the screen dropping resistor but also, with the screen by-pass, forms the decoupling filter for that stage. This will prevent feedback to the screen, provided each screen in the set is provided with an individual network of this type. Voltage divider networks for obtaining screen voltage are also permissible as long as one divider network does not supply more than one stage, except in the case of the television pentodes 6AC7/1852 and 6AB7/1853. These tubes display a sharp cutoff characteristic when the screen is supplied from a fixed source such as a voltage divider, and so in R.F. and I.F. amplification, where the variable mu

(Continued on page 736)



# TUBE REPLACEMENTS

## Part II. Tubes Requiring Voltage and Current Changes

By I. QUEEN

**P**ART I of this article discussed tube replacements in general and included a table of directly replaceable tubes which require no circuit changes. While all substitutions listed are not identical in every respect their characteristics are approximately the same as the original, so that table should be consulted first when seeking a substitution tube.

Failing to find a tube which may be directly inserted, we are confronted with the next logical choice, a tube which has similar characteristics except for its filament. The latter circuit is generally not difficult to modify for the accommodation of a different type tube. It is only necessary to know whether the filaments are wired in series or in parallel, and the voltage and current characteristics of each tube, before the change can be made.

Receiving tubes are available in a great many voltage and current values. Some have been standardized and appear more often than others. For example, the following ratings are very common:

volts	amperes
1.4	.05
1.4	.1
2.8	.05
2.8	.11
2.5	.8-1.0
6.3	.15
6.3	.3
12.6	.15

Tubes with similar characteristics are generally available in two or more of the above ratings, so that a simple change in the filament circuit makes available a different type tube.

The 1.4 and 2.8-volt tubes call for a D.C. filament source and may be operated either from a battery or a power line rectifier. These tubes are very critical as to filament voltage and current and any changes involving them must be made with great caution. Some of them are filament center-tapped so that the same tube may be operated with filament halves in series (2.8 volts at .05 amp.) or in parallel (1.4 volts at .1 amp.). This is a convenience when substitution must be made. When the filaments are series-wired we connect the new tube to consume the same current as the other tubes, and when they are parallel operated, the new tube requires the same voltage as the others. (Fig. 1).



### SERIES FILAMENTS

When a high voltage (compared to each filament) is available, the filaments may be wired in series if they consume the same current. This is the case of the A.C.-D.C. set and some battery receivers. If the replacement requires a different voltage but the same current, this change of voltage will be uniformly distributed among all the filaments and may represent a small and permissible percentage.

For example, having a series of .15 ampere tubes operated from a 117-volt source, a defective 6L5G tube may be directly replaced by a 12J5GT. The required voltage is now 6.3 more than the original circuit called for, but this represents only about 5% of 117 volts and is negligible. Replacements of this type which require no change

whatsoever in line-operated receivers are listed in Table II under "series."

In the above connection, note that if in a special case a lower voltage supply is in use (such as a 25-volt source working four 6.3-volt tubes) the percentage change when replacing a 6-volt with a 12-volt tube (or vice versa) is too high to be satisfactory. On the other hand if a series of filaments is operated from a 220-volt source, a 50L6-GT/G becomes interchangeable with a 35L6-GT/G (7% change). The latter is an unusual case and therefore does not appear in the table.

A typical series filament circuit appears in Fig. 2. The sum of the tube voltages



Fig. 2

must equal or be less than the supply, with the dropping resistor taking care of the difference. Suppose trouble develops with the rectifier. A logical replacement is the 50L6GT, identical except for the filament.

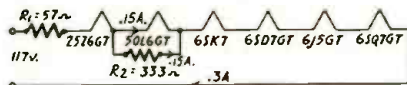

Fig. 2a

The new tube consumes less current, so that a shunt around it is required to avoid damage. The total voltage is also changed, now being 100, so that the series resistor should be smaller.

Calculations are as follows (Fig. 2a):

$$R_1 = \frac{E}{I} = \frac{117-100}{.3} = 57 \text{ ohms}$$

$$R_2 = \frac{E}{I} = \frac{50}{.15} = 333 \text{ ohms}$$

The power consumption of the set is not changed.

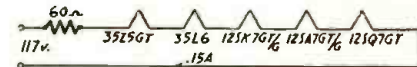

Fig. 3

Another typical circuit is shown in Fig. 3. Assume that the 12SQ7-GT/G must be replaced with an available 6SQ7-GT/G. Since the new tube now requires more current than the original, all other tubes as well as the series resistor must be shunted.

Calculations are as follows (Fig. 3a):

$$R_1 = \frac{117-102}{.3} = 50 \text{ ohms}$$

$$R_2 = \frac{95}{.15} = 633 \text{ ohms}$$

The voltage change is seen to represent only a small percentage. Therefore, if the line cord will pass the greater filament current safely, it need not be changed in any way.

If the voltage had changed by a considerable percentage because of the new tube, it might be a good idea to shunt the line resistor rather than replace it to obtain the correct value, for the following reason: (Continued on page 732)

TABLE II

Original Tube	Direct Replacement when filaments are in		Original Tube	Direct Replacement when filaments are in	
	SERIES	PARALLEL		SERIES	PARALLEL
1A5GT		1C5GT/G	6ST7		6SR7GT
"		1Q5GT	6T7G	12SR7GT	6Q7GT
1A6		1C6	6V6GT/G	12Q7GT	6F6GT/G
1A7GT		1B7GT	"		6K6GT/G
1B7GT		1A7GT	6W7G	12J7GT	6J7GT
1C5GT/G		1A5GT	7A7		7B7
"		1T5GT	7A8	14B8	7B8
1C6		1A6	"	14J7	7J7
1C7G		1D7G	"	14S7	7S7
1D7G		1C7G	7B6		7C6
1F4		33	7C6	14B6	7B6
1Q5GT/G		1A5GT	7C7	14B7	7A7
1T5GT		1T5GT/G	7B8		7A8
"		1C5GT	7G7		7H7
1V	12Z3	1Q5GT	7H7		7G7
3D6			7J7		7A8
3LF4		3LF4	7L7		7B8
6A5G		3D6	7S7		7G7
6A8GT		6B4G	7T7		7A8
6AB5		6D8G	7Y4		7G7
6AG5		6E5	7Z4		7Z4
6AK5		6AK5			7Y4
6B4G		6AG5	12A8GT	6D8G	
6B6G		6A5G	12J5GT	6L5G	
6C5GT/G		6T7G	12J7GT	6W7G	
6D8G	12A8G	6L5G	12K7GT	6S7G	
"	12K8G	6A8GT	12SR7	6ST7	
6E5		6J8G	12Z3	1V	
6F6GT/G		6AB5	14A7	7B7	
"		6K6GT/G	14B6	7C6	
6J5GT/G		6V6GT/G	14B7	7C7	
6J8G		6L5G	14B8	7A8	
6K6GT/G		6D8G	14J7	7A8	
"		6F6GT/G	14S7	7A8	
6K7GT		6V6GT/G	33		1F4
6L5G	12J5GT	6S7G	35Z5GT	40Z5	
"		6J5GT/G	"	45Z5GT	
6Q7GT		6C5GT/G	40Z5GT	35Z5GT	
6S7G	12K7GT	6T7G	"	45Z5GT	
6SR7GT		6K7GT	45Z5GT	35Z5GT	
6SS7		6ST7	"	40Z5GT	
		6SK7GT/G			

# NEGATIVE FEEDBACK

## Calculation and Design of Audio Feedback Circuits

By J. W. STRAEDE\*

THE first part of this article deals with the uses and types of negative feedback and the effects of ordinary types of feedback on power output.

Feedback as applied to most audio frequency amplifiers is of the voltage type (i.e. no current or power is fed back). This feedback is classified as "voltage" or "current" according as the voltage fed back is proportional to the output voltage or output current. "Voltage" feedback is shown in Fig. 1-a, "current" feedback in Fig. 1-b.

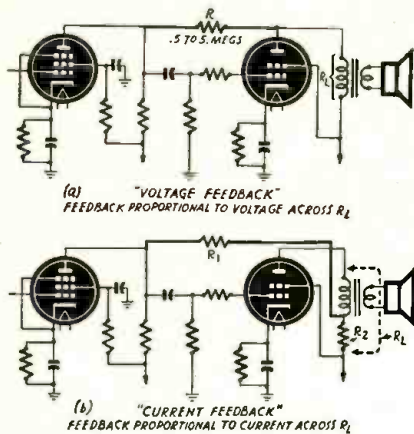

Fig. 1—The two types of feedback circuits.

The voltage fed back is usually applied to the control grid (input grid or first grid) of the output tube(s) or to some preceding portion of the signal circuit, its phase being such as to reduce the gain. Why is this feedback used at all? It may be applied for one or more of four reasons:

- To prevent oscillation or frequency distortion caused by positive feedback (reaction).
- To reduce wave-form distortion (amplitude or harmonic distortion).
- To provide frequency response variation as a tone control.
- To reduce the effects of an output load that varies with frequency.

An example of (c) is shown in Fig. 2.

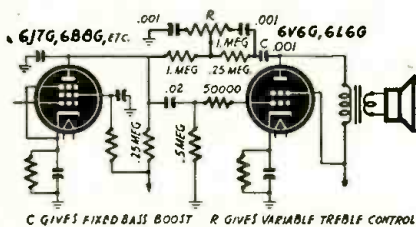

Fig. 2—Combined feedback and tone control.

Now it doesn't just mean that you apply some negative feedback and all the above happens straightaway! "Current" feedback, for instance, usually causes increased frequency distortion, especially where the distortion is due to a varying output load. Another snag is that it is often very difficult to keep the feedback negative. If the phase of the feedback voltage is changed considerably, due to capacities and/or inductances in the feedback path, the feedback may be no longer negative; it may even be

\*Lecturer in Electro-Acoustics, Melbourne Technical College (Australia).

positive and strong enough to cause oscillation at a very low or very high frequency (e.g. motorboating or hissing).

A résumé of the well-known mathematics of voltage feedback and the meanings of symbols employed will help the reader to understand.

$\alpha$  = fraction of the output voltage that is fed back.

$M$  = gain between point to which feedback voltage is applied and the output (before feedback is applied).

$m$  = reduced gain after application of feedback.

$\beta$  = gain reduction factor or  $\frac{m}{M}$

Providing there are no phase changes

then  $\beta = \frac{1}{1 + M\alpha}$  and this fraction  $\beta$  gives the reduction in gain.

The same fraction,  $\beta$  is also approximately equal to the ratio between the amounts of frequency and harmonic distortion after and before application of negative feedback. Note the "approximately"!

### AN EXAMPLE OF FEEDBACK

Let us take an actual case: Suppose a 6V6G output tube operating under the usual conditions has a power output of 4.0 watts with a load of 5000 ohms and a harmonic distortion of 8%. The peak output voltage is given by

$P = E^2/2R$ , where  $E$  is the peak voltage and  $P$  the power in watts.

$$\therefore E = \sqrt{2PR}$$

$$= \sqrt{4 \times 5000 \times 2}$$

$$= 200 \text{ volts.}$$

As the input signal required for this output is 12 volts (peak), the gain  $M$  is given by  $\frac{200}{12}$  or 16.

Suppose the harmonic distortion is to be reduced from 8% to 2%. Then a gain reduction factor of  $\frac{1}{4}$  is required.

$$\beta = \frac{1}{1 + M\alpha}$$

$$\therefore \frac{1}{4} = \frac{1}{1 + 16\frac{2}{3}\alpha}$$

$$\therefore 16\frac{2}{3}\alpha = 3 \text{ and } \alpha = .18 \text{ or } 18\%.$$

That means that at least 18% of the output voltage is to be applied to the control grid—say 20% or one-fifth to be on the safe side. One way of doing this is to connect the plate of the 6V6G to the plate of the preceding tube with a resistor which has a value equal to four (one less than five) times the resultant resistance of the preceding tube, its plate load resistor and the grid resistor in parallel. If the preceding tube is a pentode with an A.C. resistance of approximately 2 megohms, the plate resistor and grid resistors each  $\frac{1}{2}$  megohm, then the resultant resistance is  $\frac{2}{5}$  megohm and the feedback resistor should have a value of  $\frac{2}{5} \times 5$  or 2 megohms. See Fig. 3.

How will this affect the output power? Technicians generally answer this question pretty rapidly in one or two ways. Either the answer is, "It won't affect the power" or "As the effect of feedback is to reduce the distortion of 4 watts from 8% to 2% then the power at 8% distortion must be more than 4 watts, so feedback increases the usable power output." Both are wrong.

The limitations to power output are the swinging of the output tube beyond cut-off or into the positive grid region, thus making the peaks of the same amplitude as before, so the theoretical output for a square-topped wave-form input signal would not be changed. However square waves are not used in practice and cannot be reproduced by loud-speakers, nor are they handled by output transformers. How about a near-sine-wave of constant peak value?

Supplying feedback reduces harmonic distortion, but part of the output consists of this distortion, so the output is reduced also! Note: If the harmonic were out of phase with the fundamental, its removal would increase the effective power! More of this later. In practice it is found that (providing the tube is not run beyond cut-off or into grid current) the application of either voltage or current negative feedback, to the

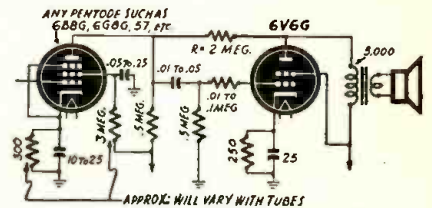

Fig. 3—Constants for given feedback ratio.

control-grid has a negligible effect on the power output. The closer the operating conditions are to optimum, the more negligible the effect. With pentode tubes there is generally a very slight decrease, with triodes hardly a change.

### EFFECTS OF REACTIVE LOADS

So far, all we've considered is a constant or "resistive" load. A loud-speaker has an impedance that varies with frequency. There is a fairly sharp rise of impedance around the bass resonant frequency and also a general rise in the "highs" due to the leakage reactance of the output transformer and inductance of the voice coil.

This rise of impedance causes a loss of power and a reduction in distortion in the case of a triode output tube but an increase in the case of a pentode. In both cases there is an increase in gain, so if the feedback fraction  $\alpha$  remains constant, there is an increase in the amount of feedback. This increased feedback has two results: First, there is a slight reduction in distortion due to the feedback itself. This effect is usually entirely masked by the second effect: The power output is decreased, not because there is less available (there IS less in the case of the triode), but because the tube is no longer driven to its full extent.

At very low frequencies, the output load (speaker impedance) drops off rapidly, causing a drop in the available power and

(Continued on page 748)

# POWER SUPPLY DESIGN

By JAMES E. DOLAN

THE direct current and voltage delivered by the rectifier of a power supply includes an alternating current component. It is the duty of the filter section to remove this alternating current component to a degree governed by the use that the direct current is to be put to. This article will describe the commoner filter systems and tell how to calculate a filter system for a given requirement.

The amount of filtering required for a specific purpose depends completely on the amount of alternating current hum permissible in the circuit. A microphone input channel will require excellent filtering because any hum present in this stage will be amplified in succeeding stages. Generally the alternating current component cannot exceed .005 of the direct current voltage for microphone input circuits. An audio-frequency amplifier may tolerate between .01 and .1 or more in the case of a class "B" stage. Some types of photoelectric equipment may tolerate 10% or even more. Certain switching circuits may be operated with no filter at all and still function reliably and accurately. In some cases a simple resistance-capacitor filter will be fully adequate.

Figs. 1 and 2 show a typical half-wave rectifier power supply system and a complete full-wave rectifier power supply. Above each diagram the functions and wave forms and proper nomenclature is indicated at each point along the filter system, the rectifier, and the transformer. By reference to these diagrams we can pick out the various components of voltage, current and frequency which are tabulated beneath the diagrams. Because of the increasing impedance offered to harmonics by the filter and as the harmonic content of the wave fed into the filter is small, if the filter is designed to handle the fundamental component of the ripple frequency it will suppress all harmonics, so the ripple due to harmonics need not be considered.

The ripple frequency is a function of the supply voltage and the type of rectification used. A half-wave rectifier delivers a ripple frequency equal to the supply frequency. A full-wave or a bridge system of rectification delivers a ripple frequency to the

filter equal to twice the supply frequency.

The condenser input filter is of particular value in low-current circuits because of the fact that for a low current drain the filter condenser can supply the required voltage to the load during its discharging cycle. By the same token, the voltage output

The complex problems of power supply design have in the past been considered too difficult for the average experimenter and constructor. Mr. Dolan has presented a simplified and very useful system of calculating constants of power supply filters.

of the condenser into a low-current load approaches the peak value of the impressed voltage delivered by the rectifier tube or tubes.

This type of set-up is economical as far as transformer and rectifier costs go, but requires twice the filtering of a full-wave rectifier system if the same ripple voltage is to be attained in both cases. The effectiveness of the voltage-gaining properties of the condenser input filter decrease with an increase in the current drawn by the load. This means poor regulation. With a half-wave rectifier the effect on the transformer is such as to reduce its efficiency by saturating the core and secondary winding with direct current, making for less efficient transformer operation. On the other hand, if the current drain is small and a high voltage is needed, this type of filter and rectifier system may be most economical and desirable. If a supply is desired for the high voltage on a cathode ray oscillograph, this type of circuit will answer the purpose in an excellent manner; the cost of parts is low, the circuit is compact, and of most importance, the current drain is low and stable. Under these conditions half-wave rectifi-

cation and condenser input are not only possible but advisable.

Three types of rectifier systems are commonly in use for single-phase current rectification, the half-wave, the full-wave, and the bridge rectifier. We may construct a chart to show the characteristics of the various types of rectifier systems and include the data required for filter circuit design. Such a chart is given in Table I:

Table I

	Half Wave	Full Wave	Bridge
$E_{ac}$ Direct current component	1.0	1.0	1.0
$E_{ac}$ RMS transformer Voltage	varies	1.11	1.11
$f_r$ Fundamental ripple frequency	60	120	120
$E_r$ Peak value of alternating current component of rectifier output	variable	.667	.667

The first and most important consideration is the amount of alternating current component at the input of the filter. This is given in the above table and is a consequence of the type of rectifier used. In the case of the half-wave system it is also a consequence of the amount of current drawn and the type of filter used. For the full-wave rectifier the value of the alternating component is .667 of the direct current component; and for the bridge rectifier circuit it is also .667 of the direct current component of the rectified output wave form.

There are three types of filter circuit to be considered in this discussion, the first being a filter consisting of only a choke and condenser; the second consisting of a two-section filter, two chokes and two condensers; the third, the resistance filter.

In considering the first filter input condenser, there are two important considerations; the smoothing effect, and the effect of the condenser on the available voltage. The actual formulae and engineering calculations involved in the calculation of the true effects of the input condenser are complicated. (Continued on page 740)

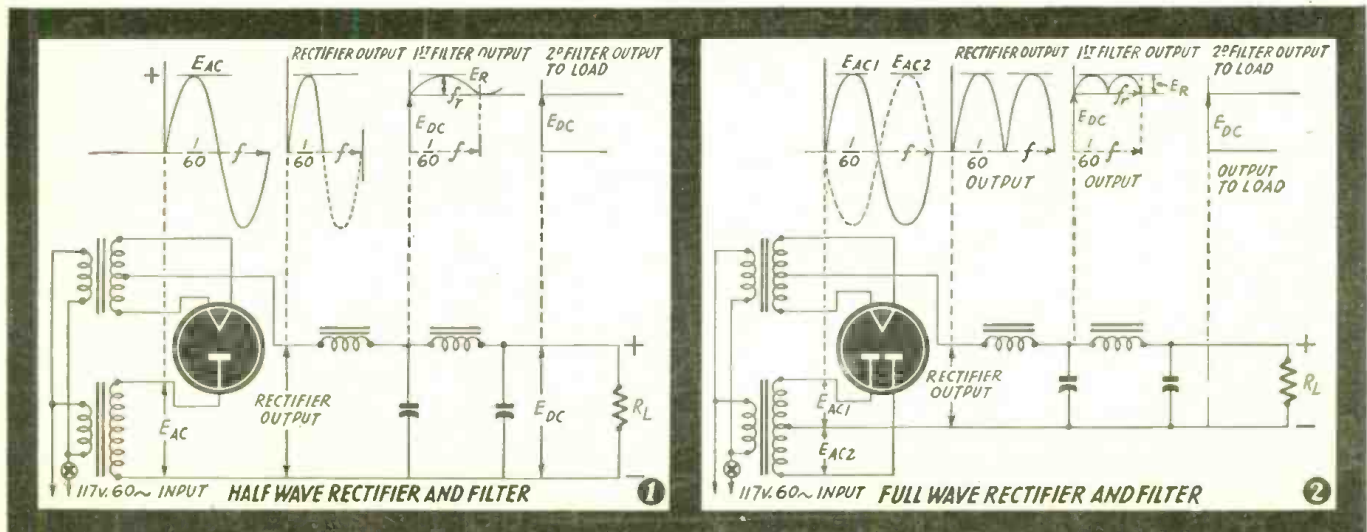

$E_{ac}$ —Transformer secondary voltage.  $f$ —Frequency of supply voltage.  $f_r$ —Ripple frequency.  $E_{ac}$ —D.C. voltage, average.  $I_{ac}$ —D.C. current, average.  $R_L$ —load resistance.  $E_r$ —peak value, fundamental component of ripple voltage. RF—ripple percentage. C—Capacity (farads).

# DETECTOR CIRCUITS

## Part I—The Diode Detector

By ROBERT F. SCOTT

**A** DETECTOR has been described as being a means of separating speech or other intelligence components from a radio frequency carrier signal. Detection or "demodulation" is necessary for practically every type of communication which utilizes a basic carrier signal of a frequency well above the audio scale.

There are several methods of separating the intelligence from the carrier. Each of these has its own particular advantages and disadvantages which will be discussed in turn. The most important of these traits are: Sensitivity, Fidelity, Signal handling capacity and Circuit loading.

Sensitivity of a detector is its ability to respond to comparatively weak signals and this ability is measured as the ratio of R.F. signal input to audio signal output.

Fidelity is the ability to handle audio signals without discrimination against frequency or amplitude. Thus a high fidelity detector will give faithful reproduction of the intelligence envelope of the modulated signal.

Signal handling ability of the detector is its ability to handle signals varying from maximum to minimum signal strength without deleterious effects from insufficient input voltage and overloading.

The circuit loading is the load which the detector circuit imposes upon the preceding

stage. It is this factor which must often be carefully calculated; because a low impedance often means that the detector will draw current, and not all preceding stages are designed to furnish the driving power.

### THE DIODE DETECTOR CIRCUIT

Perhaps the simplest and most often used detector is the diode. This employs a tube having only a cathode and anode or plate. Fig. 1-a illustrates a typical diode detector circuit as commonly employed in the receivers of today. A grid and triode plate are included in many such tubes, but play no part in the detector action. Figs. 1-b-c-d show the shape of the modulated input signal, condenser charging voltage and diode current flow respectively.

The modulated signal voltage is applied to the combination of L-C and hence between (diode) plate and cathode of the detector tube. It is well-known that the plate attracts electrons (or draws current) only when it is positive with respect to the cathode. As the input signal increases from zero in a positive direction, the plate is charged positively and electrons flow from the cathode, resulting in a current flow. This current flow passes through the load resistor, R, and there is a voltage drop across this resistor. The voltage across this resistor will be a replica of the positive half of the modulated input signal. Condenser C1, will take on a charge equal to the voltage across R which is slightly less than the peak voltage of the input cycle.

On the negative portion of the input cycle, the plate is negative with respect to cathode and there will be no current flow. This current flow is also prevented by the presence of the negative charge on the plate of the condenser which is connected to the plate through the L-C network. For the current to commence to flow, it is necessary for the peak charging voltage to

exceed the voltage on the condenser for the voltage on the plate, for subsequent cycles will be the algebraic sum of the voltage on the condenser and the peak charging voltage.

In this manner, the effects of the R.F. will be removed from the output and the voltage across R will constantly follow the shape of the modulating envelope.

For the highest detector efficiency or sensitivity, it is necessary that the value of R be made as high as practical when compared with the value of plate resistance. The ratio of  $R_p$  to R may be made from 20 to 100 for efficiencies from 80 to 95 per cent.

### USE OF CHARACTERISTIC CURVES

The average vacuum-tube manual will supply the characteristic curves of the diode detector when sine-wave voltages are applied to the input circuit with various  
(Continued on page 734)

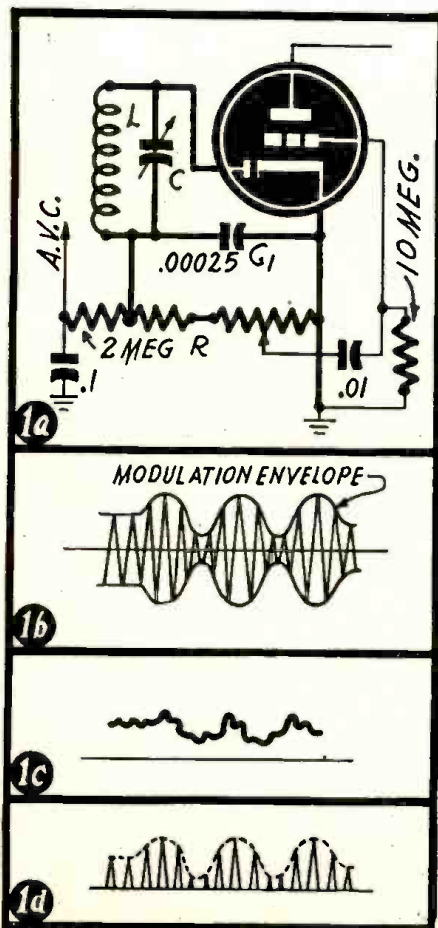
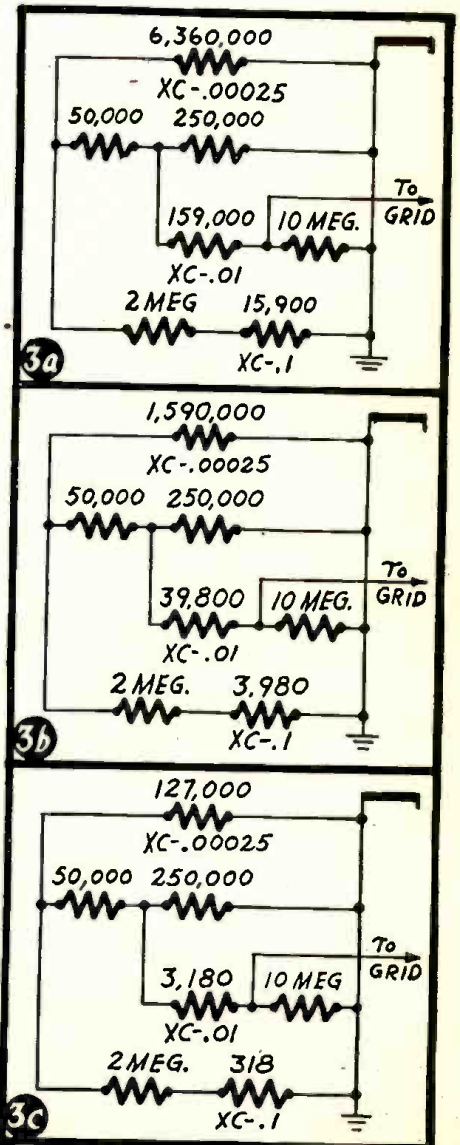
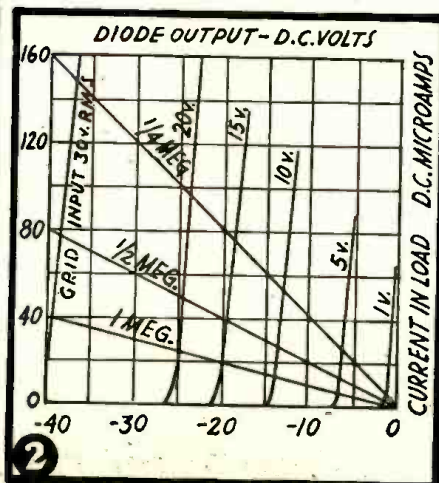

Fig. 1—Circuit of a typical diode detector.  
Fig. 2—Characteristic chart for diode tube.  
Fig. 3—Diode action at three frequencies.



# PLANNING THE SERVICE SHOP

By ROBERT DIXON

THE first step in planning a radio shop is to decide just where the shop is to be located. The beginner may set up in his kitchen or cellar, but when he has progressed to the point where he is able to go into business in earnest, we may assume that he is interested in a store site. Getting a business started is not always a simple matter. Details of electric light and power must be handled and arrangements for paying rent straightened out. As part of planning the shop, the serviceman finds it necessary to plan on stretching out his available capital. When first starting, he may not have a lot of money on hand, and what he does have may quickly be used up in buying test equipment, parts and other things.

A telephone must be installed and someone must be on hand to answer the phone when he goes out on a job, for otherwise he will be greatly limited in what he can do. He should have a car, particularly if he lives in the country. In a city—for a while—he may be able to get by without a car or truck, but it will be tough sledding. If he has a wife, girl friend, brother or someone who loves him enough to work for practically nothing, that person may be enlisted to answer the phone. Later on, he can hire a youngster to do the job and to do minor errands around the shop.

Getting a toehold is the hardest part. After the ball is rolling, things won't be so difficult. It's like getting a stalled car to roll; once you gather momentum, your own motion helps to carry you along.

In the beginning you may not be so choosy about the location selected for the simple reason that you can't afford to pay the rent in a classier place. You may be content with a hole in the wall, as the saying goes. Small stores don't cost so much to rent, but they have to be cleaned up and painted, all of which costs money and takes time. Much can be done with ambition and a paint brush. A bright, shining store front is an inducement to a customer to come in and find out what you have to offer. In these days, with servicemen off to the wars, any serviceman can make a good living because of scarcity of labor; but when times again become normal there will be competition of a keen nature. An attractive store front will help in attracting trade, and in bucking competition. The man who is able to sell himself and his service will be the successful man, while the slovenly individual who allows his shop to look like a junk shop will find he doesn't get as much business as he should.

The windows or window if there is only one window, should be periodically washed free of dirt, so that the public can look into the window and see something worth seeing. An old collection of defunct and dirty radio tubes thrown around willy-nilly in the window is not a good way to use the space. The use of appropriate window dressing material is of great value. If your finances permit it, you may rig up an ordinary cathode ray oscilloscope and arrange to have a periodic trace move across

the screen, which will attract plenty of attention. The first step in getting a customer is to attract him, and a dynamic, vital window display will help. Later, too, a neon sign, particularly one that flashes on and off, will be of value.

When you have reached the point where you have sufficient capital to branch out into a real store and wish to select a site, bear in mind that you want a location near convenient transportation if possible. For example, in a city it is a great convenience to be located a block away from a subway station rather than six blocks away, making it easy for your customers to get to you and for your employees to get to radio distributors. If you are in a town, a location near the center of the town will be of greatest value. If you visualize the hub or center of a wheel and see the spokes radiating in all directions, it's going to be easy for you to get to any particular part of the town. If you are at the tail end of town and someone calls up from the other side, a good deal of time and energy is wasted in useless traveling on service calls. Too often this important point is completely ignored. Servicemen don't seem to think much about where they locate, leaving things pretty much to chance. There may be some justification for this, but where a choice presents itself the choice should be (other factors being equal) that of a central location. Just because you live on the far side of town, it doesn't necessarily follow that your shop should be located there.

In cities such as New York, where D.C. lines are still used, it may be necessary to arrange with the power company to bring a special A.C. line from the street into the shop; and if it can't be done, for some

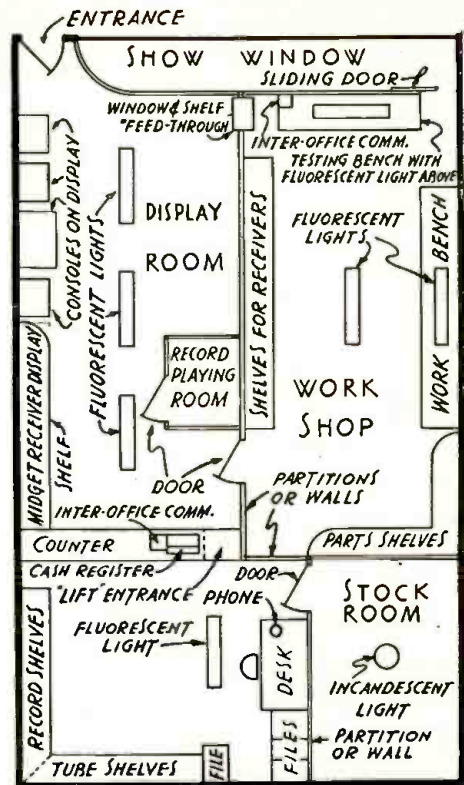
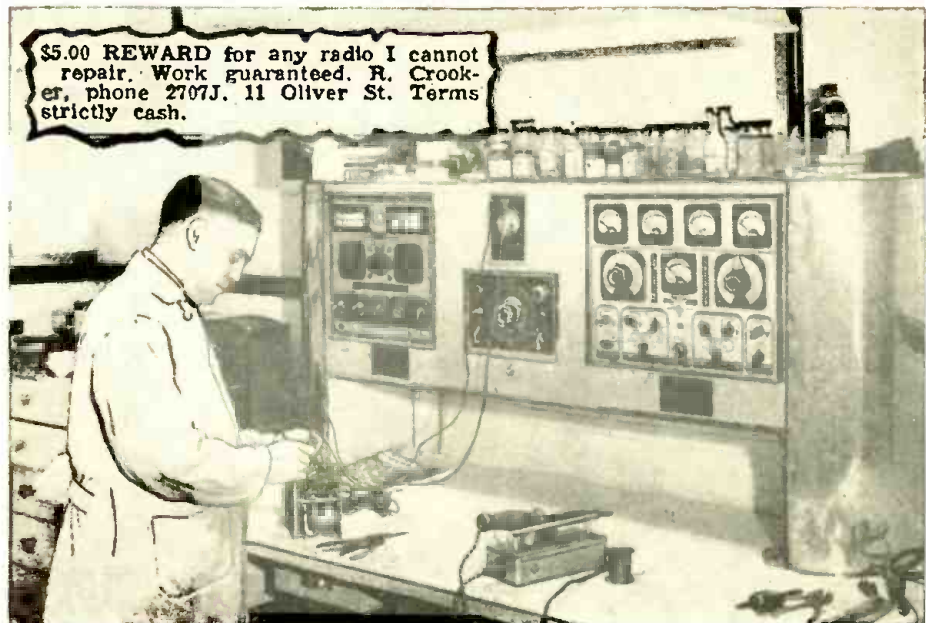

Fig. 1—Layout of a service shop planned for maximum efficiency in service and sales.

reason, a location where A.C. is available should be chosen as an alternative. Otherwise, fussing with unsatisfactory rotary converters and all sorts of trouble may be expected. Most test equipment operates on A.C. and the line regulation should be fairly good.

The lighting arrangements in the shop should be the best you can afford. In the beginning they may be anything but the best. A counter of some sort and a test bench will be needed. A desk and chair will be required, and a stool for the test bench. And that all-important gadget, the cash register, will come later. The beginner simply may not be in a position to lay out the money for a cash register, and a tin box of some sort may be used temporarily. Whether a tin box or a cash register is used,

(Continued on page 719)



A well-designed service bench in the shop of Mr. Roy Crooker, St. Thomas, Ontario.

# RADIO VOLTAGE TESTS

May Lead to Quick Solution of Servicing Problems

By JACK KING

**T**HE voltmeter is very useful in practical servicing of radio and electronic equipment because it permits rapid localization of trouble. It may be used in conjunction with standard servicing techniques, such as stage by stage testing, but is a powerful servicing tool by itself.

An experienced man may first familiarize himself with the general layout of a radio chassis, noting the different types of tubes and their location. He may, through experience, have a knowledge of the pin connections of the more common types of tubes. It is then an easy and fast procedure to put the negative test prod connection to the chassis and to rapidly shift the positive test prod to the various points to be checked for voltage.

A set may come in with the complaint "dead." After tubes have been checked as a routine measure, the set may be tested. Turning the radio on and listening to it will not be worthwhile because there is nothing to listen to in the case of a dead set, unless perhaps in some cases a low hum. Circuit disturbance or stage-by-stage methods of testing may be employed to check the defect, but it is just as easy and in many cases more straight-forward to check the operating voltages immediately since they have to be tested anyhow. The advantage of stage-by-stage testing is that only the voltages in a stage suspected of being defective need be checked usually, saving time.

Beginners don't seem to have a very clear idea of just what the voltage measurements indicate. Time and again they make the mistake of incorrectly connecting a voltmeter between plate and cathode of a rectifier circuit. The basic half-wave rectifier circuit is shown in Fig. 1. To measure



FIG. 1

the input voltage, connect the A.C. voltmeter between points 1 and 2, assuming that you have an A.C. line. If the set were plugged in on a D.C. line, a D.C. voltmeter of course would be used. The voltmeter may be a type which will read A.C. voltages of the order of 0-150 and the input voltage will usually be about 115. The output voltage of the rectifier may be about 90 to 110 volts D.C., depending on the circuit and its condition. Usually a voltage of around 100 volts is normal.

If the input voltage is not present, the trouble may be an open in a switch, a defect in the line cord, or a poor contact or loose wire at the plug. If input voltage is present and that there is no output voltage, the trouble may be an open in C or a lower than normal load resistance due to excessive leakage in the filter condensers or a complete or partial short defect in the receiver circuit. A D.C. voltmeter is connected at points 3 and 4 to check the D.C. output voltage.

A fundamental principle of importance in understanding what happens in a power supply system when the load resistance is decreased may be better understood by reference to a simplified diagram. In Fig. 2, a source of voltage has an internal potential  $E_i$  and an output potential  $E_o$ . The output potential appears across the load

resistance. The internal resistance is  $R_i$  and the load resistance is  $R_L$ . If there is no current flow in  $R_L$  there can be no voltage drop across this resistance. The output voltage would then be equal to the internal voltage of the source, which is  $E_i$ . In order not to have any current, the output resistance or load resistance  $R_L$  would need to be infinite. Now let us assume that gradually  $R_L$  is decreased in value. As this



FIG. 2

happens, a current flows in  $R_i$  and  $R_L$  due to the input or internal voltage  $E_i$ . Decreasing the net circuit resistance allows more current to flow. More current flowing in  $R_i$  which has a fixed resistance results in an increased IR drop or voltage across  $R_i$  and this leaves less voltage available for the load, since the sum of the voltage drops across  $R_i$  and  $R_L$  must equal  $E_i$  in accordance with Kirchoff's Voltage Law.

Therefore, increasing the load on a power supply by decreasing the circuit resistance will mean that the voltages will drop. This drop is in the voltage across the load, while the internal voltage drop in the supply rises. Excessive leakage in the electrolytics, a leaky grid condenser in a power output tube stage, or any circuit defect which would cause a lower than normal resistance to be placed across the power supply B plus and B minus terminals will mean a decreased output voltage.

The next basic circuit of importance in using the voltmeter for circuit analysis is that indicated in Fig. 3.  $R_1$  is a series resistance between the source and the load  $R_L$ , while  $R_2$  is a shunt resistance across the load. In order for normal voltage to appear across  $R_L$  we must have normal resistance between points 3 and 5, and 4 and 5. If the series resistance is too high or

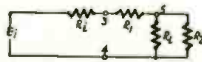

FIG. 3

the shunt resistance too low, the voltage across  $R_L$  will be lower than normal. If the series resistance is too low or the shunt resistance too high we may find that the voltage across the load is too high. Usually, most service troubles are concerned with voltages lower than normal, but it is important to visualize certain basic actions so that interpretation of meter readings can be more precise.

For example, if we have an output tube in an A.C.-D.C. set with weak emission the tube effectively has a high plate-cathode resistance. This means that less of a load will be placed on the power supply because of the high resistance between the plate and cathode and that, accordingly, there will be less current drawn from the supply and the output voltage will rise. Therefore, if we found a much higher than normal plate voltage on a tube the trouble might be due to a weak tube or to a much higher than normal bias on it. Increasing the amount of negative bias on the tube would

also raise the plate-cathode resistance and decrease the amount of current taken by the tube from the B supply.

These things are in the subconscious mind of the experienced serviceman when he makes voltage measurements. The ability to diagnose a circuit condition accurately and quickly using such measurements therefore does not come all at once. Time and practice is needed to acquire it.

A typical output tube circuit is shown in Fig. 4. If there was no voltage on the plate of VT-2 the trouble might be that a breakdown had occurred in C3 or an open in L1. Disconnecting C3 and re-checking the voltage would permit determining whether or not it was defective. If the D.C. voltage rose appreciably with the condenser out of circuit it would be very likely C3 was the trouble. If the socket itself is suspected, the wire to the plate pin could be temporarily disconnected and the voltage from that wire to B minus

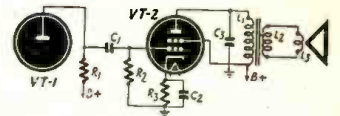

Fig. 4—Typical pentode output tube circuit.

checked. If the voltage was high when disconnected and very low with the wire connected to the socket, the trouble might well be a defective socket. The socket plate to ground resistance could then be checked with an ohmmeter, or by inspection.

In some cases lowering of the plate-cathode resistance of the tube to a very low value because of the presence on the grid of a positive voltage might be responsible for the trouble. A breakdown in C1 could cause it. C1 could be checked by disconnecting it and trying a new unit or the voltage across R2 could be tested with C1 first in, and then out of the circuit. If it is found that a D.C. voltage appears across R2 with C1 in the circuit but not with the condenser out of the circuit the trouble very likely is leakage in C1. The condenser would then need to be replaced with a good unit. If the voltage indication is obtained with C1 out of the circuit the trouble may be a short circuit in the wiring or gas in the output tube. The output tube, if oscillating, also would run into grid current and a D.C. voltage would appear across the grid resistor. Oscillation indications are usually rare and the trouble ordinarily would be a gassy tube.

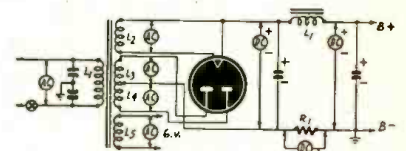

Fig. 5—Points of voltage in a power pack.

If voltage across the cathode resistor of the stage, R3, is much lower than normal, the trouble would likely be excessive leakage in C2. The condenser could be removed, the D.C. voltage again being checked. If it is now much higher a new condenser is required. If the voltage across R3 is very high in value, the resistor may have opened up or changed value, the tube may have weak emission or the condenser has opened

(Continued on page 723)

# PRECISION is a weapon in MT. CARMEL, ILL.

They use it effectively, too, these men and women who make up Meissner's *precision-el*, for many of them have sons, brothers and loved ones on the battle fronts. The photographs on this page show a few of these precisioneers who fight on the home front with precision and electronic skill as their weapons.



Precision is a family affair at Meissner. Here a letter from the front lines affects two families, and you can see that it's good news that will be reflected in the quality of their work when their rest period is over.



He's a veteran back from active service in the Pacific, but he's still fighting—this time on the home front with the men and women of Meissner. The traditions of precision quality he's learning here will be a weapon he can use after peace.



He splits thousandths of an inch as he does his war job. The "know how" that he and hundreds of Meissner *precision-el* have acquired is one more reason why you will be able to depend on Meissner quality after V-Day.



On the way to battle are these cartons of electronic war equipment. He sends them off with a smile, for he knows that the work of Meissner's *precision-el* will help bring his family together again soon.

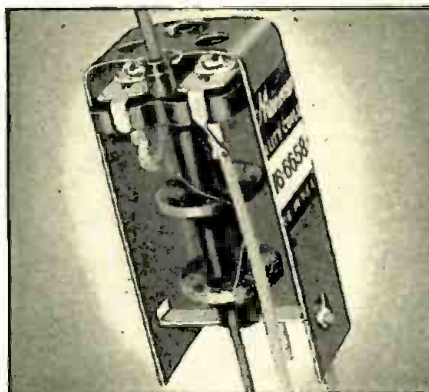

### "Step Up" Old Receivers!

These Meissner Ferrocart I. F. input and output transformers are getting top results in stepping up performance of old worn receivers. Special powdered iron core permits higher "Q" with a resultant increase in selectivity and gain, now available for frequency range 127-206. Ask for numbers 16-5728 input, 16-5730 output. List \$2.20 each.

# MEISSNER

MANUFACTURING COMPANY • MT. CARMEL, ILL.

**ADVANCED ELECTRONIC RESEARCH AND MANUFACTURE**  
Export Division: 25 Warren St., New York; Cable: Simontrica

# Save the Battery Sets

**D**O you have a good four-tube battery portable lying around collecting dust because you can't get batteries for it? Then dig it out!

Within a few hours you can convert it into a four tube A.C.-D.C. set that will outplay your original portable at its best. The job of converting it will be comparatively easy. Surprisingly few changes will have to be made. Perhaps you have been thinking, "Why not build an A.C.-D.C. power supply for it, and use the set as is. Why bother with the problems and worries of conversion?" The answer is that by converting to A.C.-D.C. you will have a much better set and one that will compare favorably with any five-tube A.C.-D.C. set. You can also get much higher undistorted output.

The common-sense approach to the problem of conversion would be to get a schematic of the set first. In some cases, this is attached to the chassis or cabinet. If that is not the case, the manufacturer will usually supply you with one. Then armed with a tube manual, you can proceed to redesign the set. Select a suitable line-up of tubes, with the same characteristics as the original ones, but with a six- or twelve-volt filament. For example: the average battery portable has the following tube line-up: 1A7, oscillator, 1N5, I.F., 1H5, second detector and first A.F., and 1C5, output. For the 1A7 you could use a 6A7 or 6A8, a 6SA7, a 12A8, a 12SA7, a 7B8-LM or a 7Q7. Any one of these types would work with suitable changes, as they are all pentagrid converters similar to the 1A7. If possible, choose a tube that has the same base as the particular tube you are replacing. The 1N5 could be replaced by a 6D6, 6K7, 6S7, 6SK7, 6U7, 6E7, 7A7-LM, 7B7, 7H7, 6SG7, 6SS7, 12K7, 12SG7, 12SK7, 14A7/12B7, 39/44, 58, 78, etc., to name just a few. The 1H5 can be replaced by a 6B6, 6Q7, 6R7, 6SQ7, 6T7, 7B6-LM, 7C6, 12Q7, 12SQ7, or a 75, as these are all duplex-

By EARL T. HARTLINE\*

diode high- $\mu$  triodes. The output tube can be chosen for its output as well as the filament voltage. Tubes such as the 32L7, 70A7, and 70L7 are particularly adaptable, though there are many others.

With the six-volt series you do not have to change the socket. With the seven- and 14-volt tubes you have to change sockets as well as the connections. Choose the best line-up in conformity with tubes you have available. For further substitutions, see I. Queen's articles on tube substitutions in the July and August issues of *RADIO-CRAFT*. An example of the tube line-up you could use would be a 6A8, 6K7, 6Q7 and a 25A7 with a 20-watt, 250-ohm resistor in series with the filaments. A line cord with the 250 ohms built in would be ideal if obtainable.

The output transformer should be changed to match the speaker to the impedance of the new output tube. Actually, in many sets this will not be necessary.

The filter choke can be a 400-ohm field coil from an old speaker, but in an emergency, 1000-ohm, 10 watt resistors have been used with fairly satisfactory results.

The two diagrams pictured show the original set, which was a Coronado Model 470, and the converted set. There are many models of these four tube portables which are similar, and the changes will be practically the same for any of them. In some cases, you might have an alignment job ahead of you due to differences in tube characteristics, but in many cases, you just have to switch the leads, put in a voltage-dropping filament resistor and make a few minor changes in the circuits. One trouble that you are likely to run into is oscillation, due to the differences in characteristics of tubes. Reduction of voltages, realignment of I.F. transformers and changes in bias may have to be resorted to, to clear up this trouble.

\* Staff Sergeant, United States Marine Corps

All that really is needed is a fair background in radio theory (which you should have, or you wouldn't be reading this magazine) and a bit of that good ol' common sense. Surprisingly enough, these two virtues go far toward making a design engineer out of a mechanic.

## ?? WHY NOT ??

Have you ever asked yourself, "Why can't I have this or that gadget on a radio? Why aren't programs made to fill such and such a need?" If so, you are a charter member of the *Radio-Craft* "Why Not" club. Send us your "Why Not's" on all subjects—serious or screwball, practical or idealistic. We will pay \$1.00 for every one we believe will interest the readers of *Radio-Craft*.

You can get the idea from the "Why Not's" printed below. Send in as many as you like. One dollar will be paid for each one printed.

Why not a law compelling manufacturers of small electric motors, lighting plants, heating pads and other potential static-producers to make their products non-interfering or else take out radio transmitting licenses on them? Note well that a precedent has been set in the enforced war-time registration of diathermy machines.—*Elmer Knoson, Kansas City, Mo.*

Why not a radio which would make servicing easier? Have a number of small neon or other indicator buttons at the back of the cabinet, each one connected across an important part of the receiver. If all indicators light, the set is in good order. If the set stops playing, and one or more indicators do not light, the serviceman will be able to locate the fault in the part to which that indicator is connected.—*J. Lindgren, Los Angeles, Calif.*

Why not play some of the recordings we hear backward? They might sound better!—*Ensign Jack Nelson, S.S. "Shiloh."*

Why not provide a special frequency for "Soap Meller-Drammers"? Then the "girls" in the kitchen could listen to their hearts' content on fixed-frequency receivers that would never need tuning, and others could avoid that spot on the band.—*Ensign Jack Nelson, S.S. "Shiloh."*

Why not put all new Hams on CW for six months after they get their licenses? Some start with phone the day they get their ticket, and a year after are unable to recognize their own call sent repeatedly to them at 5 words per minute.—*Ensign Jack Nelson, S.S. "Shiloh."*

Why not have all manufacturers of radios paste pictorial diagrams on the inside of the cabinet showing the tube layout? Some do it—why not all?—*Joseph J. Silva, Bridgeport, Conn.*

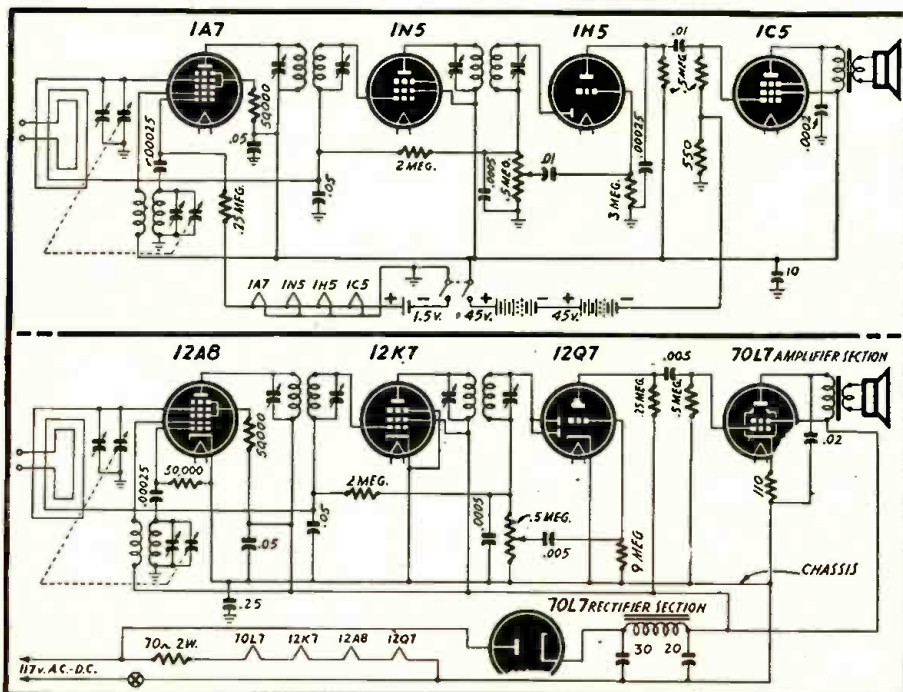
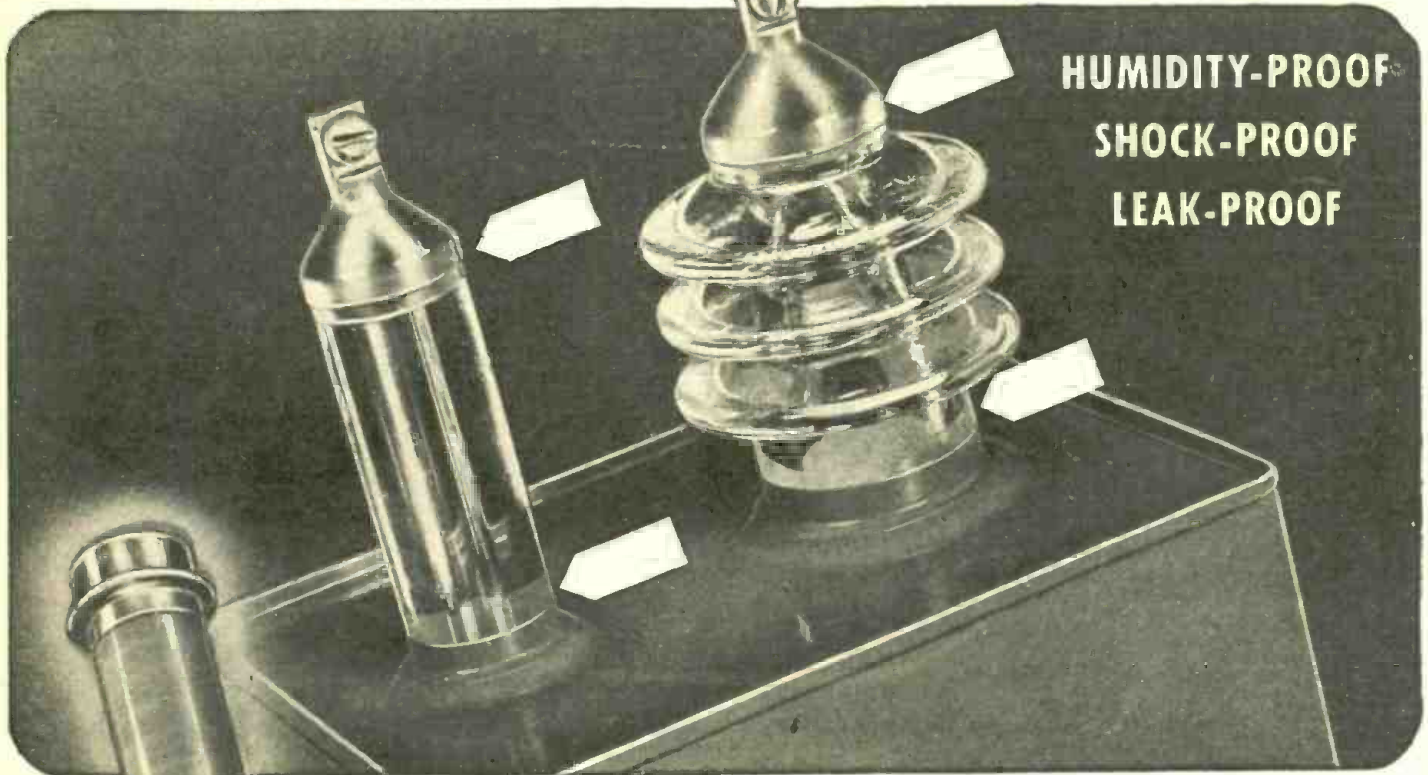

Diagram of the original Coronado, and the same set after being revised to use 12-volt tubes.



# WELDING GLASS TO METAL "COULDN'T BE DONE"...



HUMIDITY-PROOF  
SHOCK-PROOF  
LEAK-PROOF

... but here it is!

If you want to have a look at the Capacitors and Resistors of tomorrow, step in and see what has been going on in the Sprague Engineering Laboratories (if wartime restrictions would permit!). Then it will be easy to understand why Sprague has been a FIVE TIME WINNER of the coveted Army-Navy "E" Award!

against shock—and doing it without the use of glass bushings or adjacent metal rings with "matched" temperature coefficients of expansion. Actually, there were many "scientific" reasons why glass could not be fused to metal—but Sprague not only proved that it could be done, but done economically and in tremendous quantities.

A typical example is the Sprague Electric Co. glass-to-metal seal. This amazing development answers the old problem of sealing Capacitors and Resistors against leaks and moisture, guarding them

This sort of accelerated wartime engineering is reflected throughout the entire Sprague line—and that means unsurpassed quality for every unit used on every day radio work!

**THE TRADING POST  
CONTINUES!**

Sprague's famous free buy, sell, or exchange advertising service "THE SPRAGUE TRADING POST" appears on page 684 of this issue—and will continue to appear as long as wartime shortages create a need for it. Meanwhile, we'll appreciate it if you continue to use Sprague Capacitors and Koolohm Resistors—and to ask for them by name!

**SPRAGUE PRODUCTS COMPANY, North Adams, Mass.**

*(Jobber Sales Organization for Products of the Sprague Electric Co.)*

# SPRAGUE

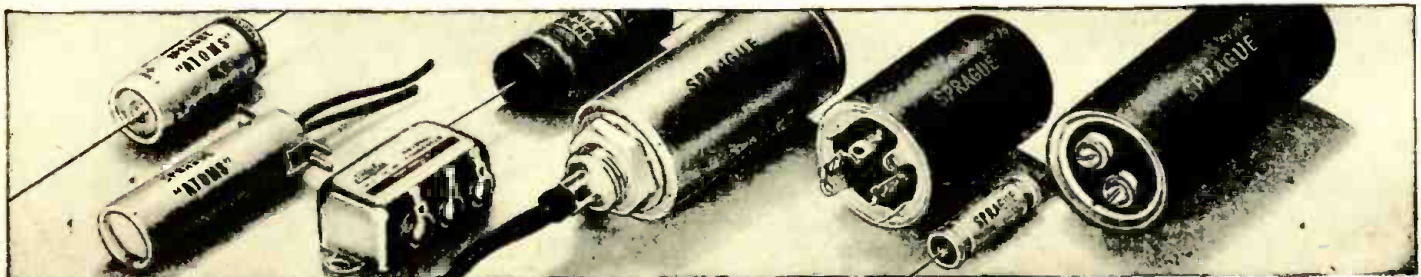

**CAPACITORS FOR EVERY SERVICE, AMATEUR AND EXPERIMENTAL NEED**

# New Shortwave Converter

VARIOUS circuits of S.W. converters in which a triode achieved the complicated process of frequency changing with the minimum of components have appeared from time to time. Only one coil and one tuning condenser need be employed, in contrast to the usual method of tuning the signal circuit and oscillator circuit simultaneously by means of a ganged condenser. That such circuits worked, their widespread publication is sufficient guarantee.

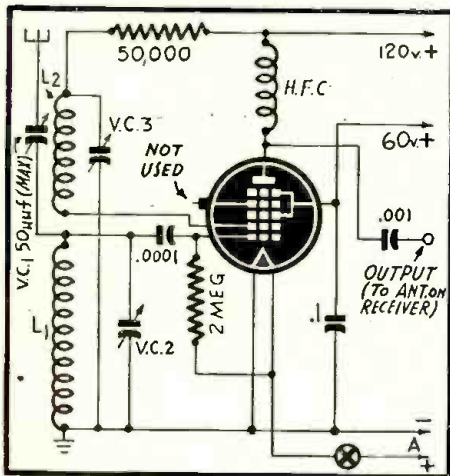

An oscillating tube generates many harmonics over and above the "fundamental" to which its grid or plate circuit is tuned. Such is the abundance of these harmonics that one or other of them is nearly certain to "beat" with any incoming frequency and to produce a resultant frequency which can be passed on to the broadcast receiver.

Many constructors tend to fight shy of the more elaborate forms of S.W. converters, such as the types employing a heptode or pentagrid tube. Admittedly, such types need some care in their construction, and there is the added cost and complication of two tuned circuits. Short-wave ganged condensers are not easily had in these days, while the alternative—two separate short-wave tuning condensers—are not as convenient to handle.

I have been experimenting recently with a heptode to determine if it was possible to evolve a circuit which combined the virtues of the more complicated converter with none of the vices of the simpler type, and the figure shows the result.

It will be noticed that the two grids which normally serve only the oscillator section of the frequency changer, now become the signal and oscillator electrodes. The first grid is both signal and oscillator grid, while the second grid is the oscillator anode. The output is taken from the plate after traversing the whole tube. The usual control grid, the top cap, is *not* used.

It might perhaps be thought that we could apply a positive potential to the usual control grid, and so help the electrons along on their way to the anode. Such a potential, however, scatters the virtual cathode and renders the tube inoperative.

The coils used are of the simplest character, just a 4-pin coil with the windings  $L_1$  and  $L_2$ . These are connected in the right direction to produce oscillations, as of course the tube must oscillate all the time while receiving stations. The coil,  $L_1$ , may be of 12 turns on a  $1\frac{1}{2}$  in. diameter form,

By WM. NIMMONS

spaced about  $\frac{1}{8}$ -inch per turn and  $L_2$  is 7 turns of thinner wire interwound with the other. Other coils may be wound for various wavebands. Regeneration condenser,  $VC_3$ , may be replaced by a .001 mfd. fixed condenser with a slight loss of efficiency. (I mention this in case anyone wishes to have a "one-knob control".) By controlling the depth of oscillation with a variable condenser, one can obtain the utmost sensitivity for stations with widely varying strength, and this is to be recommended. The condenser,  $VC_2$ , is the usual short-wave condenser of .0001 to .00016 mfd., and should have a good slow-motion drive.  $VC_1$ , of 50 mmfds. capacity, is an important adjunct, as it enables the oscillator to generate suitable oscillations to beat with

the incoming frequency, and should be carefully handled. In all cases it should be set for maximum signals. H.F.C., the high-frequency choke, should be an all-wave one, or a short-wave in series with a standard choke, the short-wave being next to the plate.

To use the converter connect up the aerial and ground, and join the lead marked "output" to the aerial terminal of the broadcast receiver. With all batteries connected ("B—" is secured through the "A—" connection when the same batteries are used for set and converter) set the broadcast receiver to the low-frequency end of the band and then tune on the converter. It may be necessary to make a few settings to find a spot not subject to interference from a strong local station. Once this has been found you will not need to touch the set.—*Practical Wireless*, London, England.

## More On Battery Set Conversions

By GERALD EVANS\*

SUPPLEMENTING Mr. W. G. Eslick's article on conversion of old radios from battery to electric operation, which gave *Radio-Craft* for May, 1945, a new high in service value, a few following brief suggestions will save hours of time on some of the more obstinate cases.

If a ballast tube is used, the pilot light is automatically taken care of, but if a line cord is used, or a power resistor, then connect a 40 or 50 ohm resistor in series with the filament string, between the line resistance and the rectifier filament if a cord type is used, between the power line and the power resistor if a resistor inside the set is used. If a power resistor is used instead of a line cord, use 30-watt or higher rating. But the 40- or 50-ohm resistor need only be a 5-watter. Use a 44 or 46 pilot.

Oscillation is certain to be experienced on some jobs. Separate cathode resistors and bypass condensers on 6A8 and 6K7 will be far more effective than resistor and condenser combinations in the B plus line of these two tubes. Even this will fail at times. Try every known system to stop oscillation, checking all wiring for errors. Then if it still persists, remove the first I.F. transformer from its can and change wiring as follows: Connect start of secondary to control grid, finish to AVC line. Connect finish of primary to plate, start to B-plus. Don't make this change unless all other systems fail. This will stop the worst of them. Do *not* detune the I.F. amplifier transformers to stop oscillation.

Never place the A.C. switch anywhere except in the chassis-to-line position. Installing it between the line and filament string will give rise to hum pickup in the volume control to 1st audio grid. This is only true where volume control and switch are one unit.

Install in the plate circuit of the 6Q7 tube two resistors in series, 150,000 and 100,000 ohms, latter connecting to B-plus. Bypass junction with .1 or .2 mfd. condenser. Serious hum will result if this is omitted, and speaker is capable of low frequency response. The 150,000-ohm resistor will substitute the .2 meg. plate resistor in 6Q7 circuit. Much better results have been

\**Evans Radio Repair*, Ola, Kansas.

secured by changing 8 meg. grid resistor of the 6Q7 to .5 meg. and using a cathode resistor in its cathode circuit, value 4500 ohms. Bypass with 10-mfd. 25-volt condenser if speaker is larger than 5 inches. Five inch or smaller, a 2 mfd. paper condenser will do practically as well. Instead of .05 mfd. condenser feeding signal to grid of 6Q7, try .01 mfd. The .05 mfd. will give serious delay action to the audio signal, and can result in distortion.

Add all filament voltages as follows: 25 volts for 25Z5, 25L6, 43, etc., 6 volts for each 6.3 volt tube. Ballast or line cord loss to make total set line voltage add up to 120 volts at least, allowing 4 volts for pilot light. Try to keep total voltage between 120 and 125 volts. Multiply ballast resistance by .3 and add result in as though a tube. Keeping total added voltage above 120 volts may not seem important, but will after a few jobs totaling less than 120.

Avoid the use of 1.4-volt tubes in A.C.-D.C. conversion unless you enjoy comebacks. Besides, they make a very poor excuse for an A.C.-D.C. radio. No difference will be noted between the 39/44 and 6K7 as I.F. amplifier tubes. Likewise the 43 will practically equal the 25L6 if a good PM dynamic speaker is available. Bypass the plate of the 43 with a .006-mfd. 600-volt condenser, the 25L6 with a .01-mfd. (??—*Editor*) Never fail to change the output transformer.

If the old I.F. transformers were not litz-wound, replace them with litz-wound types. If they were litz-wound, and indicate a difference in D.C. resistance, replace them. There might have been a difference originally in D.C. resistance of the windings, but on the other hand strands may have opened up, changing the overall D.C. resistance, and no chances can be taken in having to tear radio down again.

It is not advisable to change tuned R.F. or oscillator coils. This is especially true where the oscillator section of the condenser gang is of the tracker type. Real tracking trouble can be encountered here.

Use a 3- to 5-meg. resistor in grid circuit of output tube, for improved tone range, and a 30,000-ohm resistor to screen of 6A8 for increased sensitivity.

## FACTORY RADIOMEN

(Continued from page 693)

The precautions in installing, the defects which need correction, and the complaints to be serviced will not be very different than those encountered in any other type of radio or audio equipment.

Much industrial apparatus is similar to communications equipment in that it comprises industrial amplifiers and oscillator units. This equipment includes high-frequency induction and dielectric heaters, elevator leveling equipment, diathermy apparatus, metal and intrusion detectors, etc.; amplifiers used for spectrophotometers, frequency standards and sound meters.

Although the end use to which these units may be put will be new, the principles involved will be within the ranges with which the serviceman has worked previously and the precautions to be observed are also typical. Included with the familiar circuits will be found some new and unfamiliar ones which must be studied carefully.

The radio technician who has kept up to date on the circuits used in electronic devices as well as in television and radar, will find himself much better prepared than his less-wide-awake friend. Technicians who understand the operation of clipping, discriminating, scanning and pulsing circuits will find themselves at home.

### MORE NOVEL APPARATUS

Control devices form a very important branch of the industrial electronic family. In this category we find the photoelectric relay, timers, and contact amplifiers employing only one or two tubes. In these, grid rectification is used in novel ways. Although the devices are simple, they require a new concept on the part of the high-frequency technician, who must think in terms of a single cycle rather than wave trains. He must also master the grid-controlled gas-filled tubes, the thyatron, and ignitron, used for heavier control applications and for supplying controlled power. Control of these tubes (by shifting the phase of the grid in most cases) involves a number of more or less complex phase-shifting. D.C. amplifiers, with their own peculiar problems, must also be mastered.

Heavy industrial electronic equipment including large power conversion units such as ignitron and tank type mercury-arc power rectifiers, inverters and frequency changers, call for some entirely new ideas.

The rectifier—single- or multi-phase—is well known to every radio man. Inverters are low-frequency oscillators using gas-filled tubes. Frequency changers are simply combinations of inverters and rectifiers.

To the average serviceman who is used to thinking in terms of milliamperes, milliwatts, and microvolts, the fact that he will now deal with power rectifiers capable of supplying 5,000 amperes at 600 volts, will come as a shock. The power that can be developed equals 3,000,000 watts if the high voltage were short circuited.

The radioman interested in such apparatus would do well to obtain a good training in this field. If facilities are available through central station or power utility sources, so much the better.

Eventually the majority of jobs done in industry will be accomplished by electronically operated or controlled machines as many simpler tasks are being done today. Tasks such as counting, sorting, inspecting, synchronizing, and regulating are already the duties of the electron either directly or indirectly. The up-to-date radio man can make these pay off.

# AMPLIFIERS INTERCOMMS RECORDERS

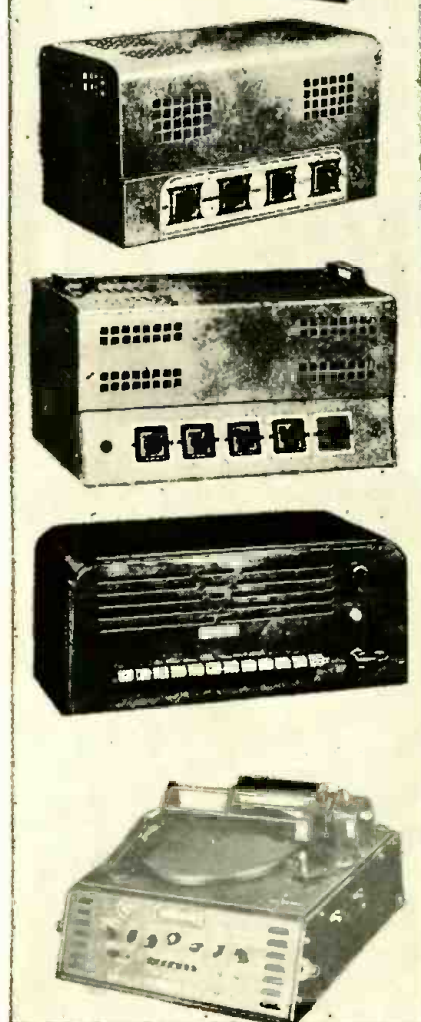

## Write for This Important New CONCORD Presentation

"Sound Equipment"—ready now—a new up-to-the-minute Concord folder illustrating and describing our complete line of Amplifiers, Intercomms and Recorders AVAILABLE FOR IMMEDIATE SHIPMENT.

**Amplifiers**—ranging in output ratings of 17 watts to 75 watts A.C.—also 6-volt units with and without built-in phonograph. Complete listing of speakers, microphones and essential equipment also included.

**Intercommunication Systems**—master and sub-station combinations for every purpose from 2 to 100 stations. Push button control, universal operation, "busy signal" and "call waiting light" features.

**Recording Equipment**—professional type for microphone recording, radio recording, transcriptions, public address.

**Engineering Service**—Our engineering service is at your command, without charge, to answer any and all "Sound Equipment" questions.

Mail the coupon below for your copy of "Sound Equipment" now.

# CONCORD

## RADIO CORPORATION

Lafayette Radio Corporation

CHICAGO 7, ILL. ATLANTA 3, GA.  
901 W. Jackson Blvd. 265 Peachtree Street

CONCORD RADIO CORP.  
901 W. Jackson Blvd., Dept. RC-85  
Chicago 7, Illinois



Please send me at once copy of your new "Sound Equipment" folder.

Name.....

Address.....

City..... State.....

# World-Wide Station List

Edited by ELMER R. FULLER

THE truth has been let out of the bag regarding our old clandestine transmitter, Deutscher Kurzwellen Sender Atlantik, which many thought was being operated by the German underground movement. Now it is known that it was operated by the allied governments to lower the morale of the few Germans who dared to have and to listen to a radio. Its location has not yet been disclosed, but it is believed to be outside of Germany.

Another radio drama was ended with the capture and return to England of the rene-

gade, William Joyce, who became known to the world from the German propaganda broadcasts as "Lord Haw Haw". As this is being written, it is expected that he will be tried in England, not as a war criminal but as a traitor to the British government, of which he is a citizen.

Radio Brazzaville is being heard fine business on 17,955 megacycles during the afternoon and early evening. Many changes have been made in the frequencies and schedules of the U. S. stations. Moscow has been heard recently on the east coast

on 15,750 megacycles about noon. V L G 4 from Melbourne is now heard at 11 to 11:45 am. on 9,580 megacycles.

For several weeks, sun spots have had a strong effect upon radio waves. Considerable fading and weak signals have been experienced from nearly all stations. We sure hope that this condition will not last, as we are anxious to pull in some of the transmitters that can only be heard in the summer and early fall. So far this summer, nothing unusual has been heard.

All schedules Eastern War Time.

Freq.	Station	Location and Schedule	Freq.	Station	Location and Schedule	Freq.	Station	Location and Schedule
12.040	GRV	LONDON, ENGLAND; Australia, 1:45 to 6 am.	15.210	—	MOSCOW; U.S.S.R.; 6:45 to 7:25 pm.	15.330	MTCY	HSINGKING, MANCHUKUD; Last heard at 1 to 3 am; Japanese controlled.
12.070	CSW	LISBON, PORTUGAL; heard 2:30 to 4 pm.	15.225	JTL3	TOKYO, JAPAN; 6:15 to 8:15 pm.	15.340	KNBX	SAN FRANCISCO, CALIFORNIA; South African beam, 11 to 1:05 am.
12.095	GRF	LONDON, ENGLAND; Near East, noon to 1:15 pm; Italy, 6 am to 1:15 pm.	15.230	VLG6	MELBOURNE, AUSTRALIA.	15.350	WRUA	BOSTON, MASSACHUSETTS; European beam, 8:30 am to 7 pm.
12.110	HI3X	LONDON, ENGLAND; Near East, noon to 1:15 pm; Italy, 6 am to 1:15 pm.	15.230	WLWL2	CINCINNATI, OHIO; North African beam, 6:30 to 8:15 am; 9 to 9:45 am; 10 to 11:45 am; 1:45 to 7:15 pm; Central African beam, noon to 1:30 pm.	15.355	KWU	SAN FRANCISCO, CALIFORNIA; Hawaiian beam, 11:30 am to 3 pm.
12.115	ZNR	CIUDAD TRUJILLO, DOMINICAN REPUBLIC; noon to 5 pm.	15.230	—	MOSCOW, U.S.S.R.; 6:45 to 7:25 pm.	15.375	GRE	LONDON, ENGLAND.
12.175	—	ADEN, ARABIA; 11:15 am to 1:15 pm daily.	15.240	KNBI	SAN FRANCISCO, CALIFORNIA; Oriental beam, 4 to 6:45 pm; 7 to 9 pm.	15.420	GWD	LONDON, ENGLAND; Pacific, 4:45 to 6 am.
12.190	LSN3	MOSCOW, U.S.S.R.; 11:10 to 11:20 am.	15.250	WLWK	SAN FRANCISCO, CALIFORNIA; Oriental beam, 4 to 6:45 pm; 7 to 9 pm.	15.430	—	MANILA, PHILIPPINES; used call CITT under Japanese at 8 pm; not heard since recapture by Americans.
12.235	TFJ	BUENOS AIRES, ARGENTINA; 7:15 pm.	15.250	WLWRI	CINCINNATI, OHIO; South American beam, 6 to 8:15 pm.	15.435	GWE	LONDON, ENGLAND; Middle East, 1 to 4 am; 5 to 11:15 am.
12.265	—	REYKJAVIK, ICELAND; Saturdays, 10 to 10:30 pm.	15.260	GS1	CINCINNATI, OHIO; European beam, 7 am to 6 pm.	15.450	GRD	LONDON, ENGLAND; Africa, 11:30 am to 2:15 pm.
12.270	—	MOSCOW, U.S.S.R.; 11:10 to 11:20 am.	15.270	WCBX	LONDON, ENGLAND; Africa, 11:30 am to 5 pm.	15.450	—	SINGAPORE, STRAITS SETTLEMENTS; "Radio Shonan." Location unknown; heard point to point with New York.
12.445	HCJB	HAVANA, CUBA; evenings.	15.280	WCBX	NEW YORK CITY; European beam, 6:30 am to 4:45 pm.	15.450	KKR	Location unknown; heard point to point with New York.
13.000	HDD	QUITO, ECUADOR; evenings.	15.280	WNRE	NEW YORK CITY; European beam, 6:30 am to 7 pm.	15.575	CMA5	HAVANA, CUBA; 7:45 to 8:30 pm.
13.650	WNRI	QUITO, ECUADOR; 3:45 to 4:30 am.	15.290	KWIX	NEW YORK CITY; European beam, 6:30 am to 7 pm.	15.595	FZ1	BRAZZAVILLE, FRENCH WEST AFRICA; 11:45 am to 12:55 pm.
13.050	KNBA	NEW YORK CITY; European beam, 6 am to 8:30 pm.	15.290	KWIX	SAN FRANCISCO, CALIFORNIA; Oriental beam, 4:25 to 6:25 pm.	15.670	VR6	JAMAICA, BRITISH WEST INDIES.
14.540	—	SAN FRANCISCO, CALIFORNIA; East Indies beam, 1 to 2:45 am; 3 to 4:45 am; Oriental beam, 4 to 6:45 pm; 7 to 9:05 pm.	15.290	WRUL	BOSTON, MASSACHUSETTS; Caribbean beam, 6:15 to 7:15 pm.	15.750	—	MOSCOW, U.S.S.R.; 6:45 to 7:25 pm.
14.560	WNRX	PARIS, FRANCE; heard with Army Hour for New York.	15.300	—	MANILA, PHILIPPINES.	15.810	LSL3	BUENOS AIRES, ARGENTINA; heard mornings.
14.800	WQV	NEW YORK CITY; European beam, 6 am to 7:15 pm.	15.300	GWR	LONDON, ENGLAND; South American, 6 to 7:15 am.	15.905	MCD	PARIS, FRANCE; "Station Paris" Calls CBS and NBC for press reports and relay broadcasts from European war theatre.
14.950	—	PARIS, FRANCE; "Station Paris"; calls NBC and CBS with press reports.	15.310	GSP	LONDON, ENGLAND; North America, 7:15 am to 5 pm; Africa, 2 to 4 am.	17.445	HVJ	VATICAN CITY; heard at 11 am.
15.000	WWV	WASHINGTON, D. C.; U. S. Bureau of Standards; frequency, time and musical pitch; broadcasts continuously day and night.	15.315	VLC4	MELBOURNE, AUSTRALIA; North American beam, 9:45 to 11 pm.	17.700	GVP	LONDON, ENGLAND.
15.060	GWG	—	15.315	VLQ3	SYDNEY, AUSTRALIA; 12:45 to 1:15 am.	17.715	GRA	LONDON, ENGLAND.
15.070	GWC	—	15.325	JLP2	TOKYO, JAPAN; 11:30 pm to 12:30 am.	17.730	GVQ	LONDON, ENGLAND; Near East, 7:30 to 11:30 am.
15.105	—	—	15.330	WGE0	SCHENECTADY NEW YORK. European beam, 6:30 to 9 am; 9:15 to 10:30 am; 10:45 am to 12:30 pm; 12:45 to 3:15 pm; 3:30 to 5:45 pm; South American beam, 6 pm to midnight.	17.750	WRUW	BOSTON, MASSACHUSETTS; Central American beam, 8:30 to 10:15 am; 7:30 to 9:15 pm; European beam, 10:30 am to 3:45 pm.
15.110	—	—				17.760	KWID	SAN FRANCISCO, CALIFORNIA; South American beam, 4 to 8:30 pm.
15.110	HCJB	QUITO, ECUADOR; 4:30 to 6:30 pm.				17.760	KWIX	SAN FRANCISCO, CALIFORNIA; South American beam, 10 am to 4 pm.
15.120	KRCA	SAN FRANCISCO, CALIFORNIA; Hawaiian beam, noon to 1 am.				17.760	KROJ	LOS ANGELES, CALIFORNIA; New Guinea beam, 9 to 11:45 pm.
15.120	KRCQ	SAN FRANCISCO, CALIFORNIA; Hawaiian beam, noon to 3 pm.				17.770	KROJ	LOS ANGELES, CALIFORNIA; Alaskan beam, 6 to 8:45 pm.
15.130	KGEX	SAN FRANCISCO, CALIFORNIA; South American beam, 11 am to 5 pm.				17.780	WNBI	NEW YORK CITY; South American beam, 6 to 7:15 pm.
15.130	KGEI	SAN FRANCISCO, CALIFORNIA; South American beam, 5 pm to 1:05 am.				17.780	WRCA	NEW YORK CITY; European beam, 7:30 am to 3:30 pm.
15.130	WRUL	BOSTON, MASSACHUSETTS; Mexican beam, 9:30 to 10:15 am.				17.780	KROU	SAN FRANCISCO, CALIFORNIA; Southwest Pacific beam, 4 to 6 pm.
15.130	WRUW	BOSTON, MASSACHUSETTS; European beam, 6:30 to 8 am.				17.780	KNBA	SAN FRANCISCO, CALIFORNIA; East Indies beam, 9:20 pm to 12:45 am.
15.140	GSF	LONDON, ENGLAND; Australia, 7:45 to 10 am; Near East, 1:45 am to 1:15 pm; India, 7:45 to 11:15 am.				17.790	CSG	LONDON, ENGLAND.
15.150	WRCA	NEW YORK CITY; Brazilian beam, 5 to 7:45 pm; European beam, 3:45 to 4:30 pm.				17.800	WLWO	CINCINNATI, OHIO; South American beam, 6 to 6:45 pm; European beam, 8:30 am to 3:45 pm.
15.150	WNBI	NEW YORK CITY; European beam, 9 to 11:30 am; South American beam, 1 to 3:30 pm.				17.800	KRHO	HONOLULU, HAWAII; Chinese-Japanese beam, 7 pm to 2:45 am.
15.150	KNBI	SAN FRANCISCO, CALIFORNIA; East Indies beam, 1 to 2:45 am; 9:20 pm to 12:15 am.				17.810	GSV	LONDON, ENGLAND; Australia, 6 to 10 am; Africa, 5 to 11:15 am; India, 3 to 10 am.
15.150	WNBI	NEW YORK CITY; Brazilian beam, 11:45 am to 12:45 pm.				17.820	APH	ALLIED HEADQUARTERS IN ITALY; heard mornings with press reports for New York.
15.155	SBT	STOCKHOLM, SWEDEN; 11 to 11:55 am.				17.830	WCBN	NEW YORK CITY; European beam, 6:30 am to 2:45 pm.
15.160	JZK	TOKYO, JAPAN; heard at 8:30 pm.				17.870	GRP	LONDON, ENGLAND; Africa, 11:30 am to 1 pm.
15.170	TGWA	GUATEMALA CITY, GUATEMALA; daytime transmissions.				17.955	WLWL1	CINCINNATI, OHIO; South African beam, 10 to 11:45 am; noon to 1:30 pm; European beam, 6:30 to 8:15 am; 9 to 9:45 am.
15.180	GSO	LONDON, ENGLAND; Pacific, 6 to 8 am; South America, 12:15 to 3:45 pm; India, 2 to 4 am.				18.025	GRQ	LONDON, ENGLAND.
15.190	CBFZ	MONTREAL, CANADA.				18.080	GVO	LONDON, ENGLAND; South America, 7 to 8 am; 10 to 11:15 am; 12:45 to 1:45 pm.
15.190	WOOC	NEW YORK CITY; European beam, 6:30 am to 7:15 pm.				18.135	YDA	BATAVIA, JAVA (NETHERLAND EAST INDIES).
15.190	KROJ	LOS ANGELES, CALIFORNIA; Southwest Pacific beam, 4 to 5:45 pm.				18.160	WNRA	NEW YORK CITY; European beam, 7 am to 4 pm.
15.200	WLWS1	CINCINNATI, OHIO; South American beam, 8:45 to 10:15 am; 11:45 to 3:30 pm; 6 to 8:15 pm.				18.180	WLWS2	CINCINNATI, OHIO; South Amer-
15.210	KGEX	SAN FRANCISCO, CALIFORNIA; Philippine beam, 5:15 to 11:15 pm.						
15.210	WBOS	BOSTON, MASSACHUSETTS; European beam, 7 am to 5:45 pm.						



Suggested by: Gus Britzman, Houston, Mo.

"Hello, are you the new eye doctor? Come quick!"

(Continued on page 728)

# IT'S A HUNDRED TO ONE YOU'LL FIND THE RIGHT CONTROL

## In IRC'S New CENTURY LINE

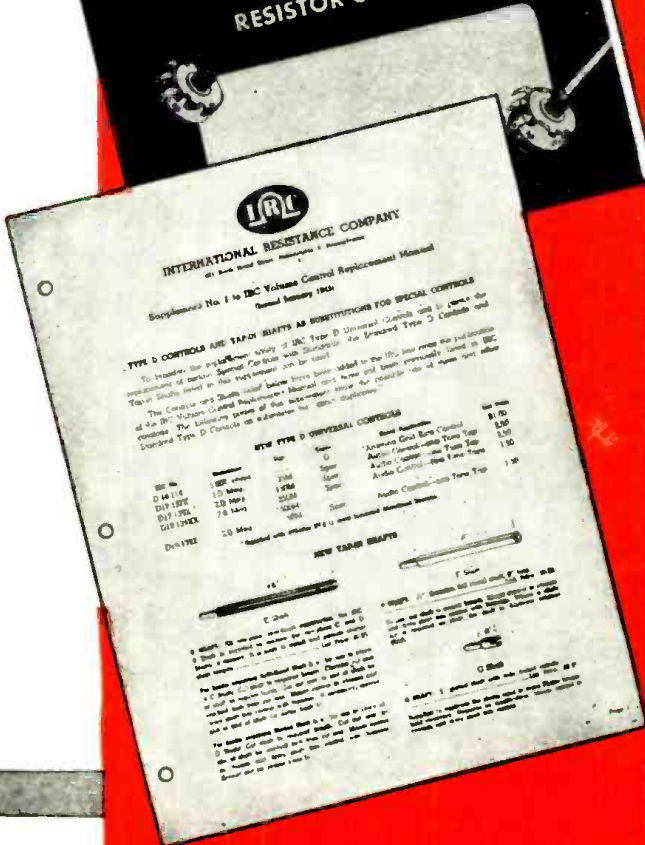

**HERE'S WHY...** In order to keep Servicemen supplied with the volume controls they require for a vast majority of their replacement needs, IRC recently introduced the "Century Line." Through concentration of manufacturing efforts on these carefully selected, one hundred controls you are assured sufficient quantities in a selection that will solve over 90% of your day-to-day service problems. All controls included in the "Century Line" are of the same high IRC quality for which the industry has always shown preference.

**HERE'S HOW...** To select the right control for the job at hand, look up the make and model of the set in the alphabetical listing in IRC's Volume Control Replacement Manual. Chances are you'll find the IRC control number listed right there. If however, an exact duplicate is called for, one further step is necessary. Look up the "J" number (exact duplicate) in Supplement No. 1. Directly opposite the duplicate part number you'll find the IRC "Century Line" number you can use for satisfactory replacement. It's as easy as that!

If you do not have an IRC Volume Control Replacement Manual or a copy of Supplement No. 1 you can readily obtain one from your IRC Distributor—or by writing direct to Dept. 25-II.

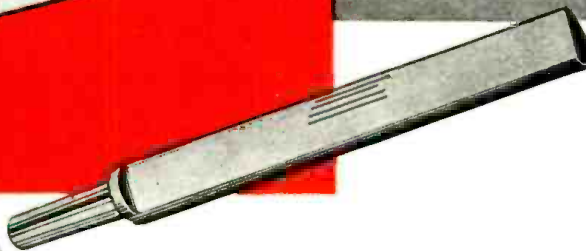
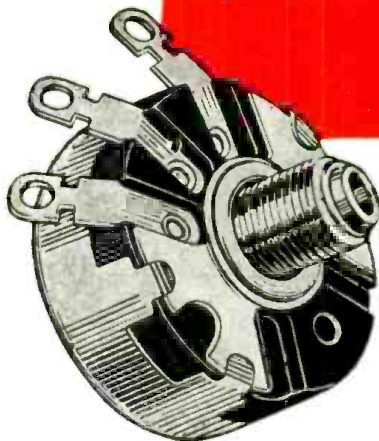

**INTERNATIONAL RESISTANCE CO.**  
401 N. BROAD STREET • PHILADELPHIA 8, PA.

IRC makes more types of resistor units, in more shapes, for more applications than any other manufacturer in the world.

**PERFECTION IS OUR ONLY AIM!**

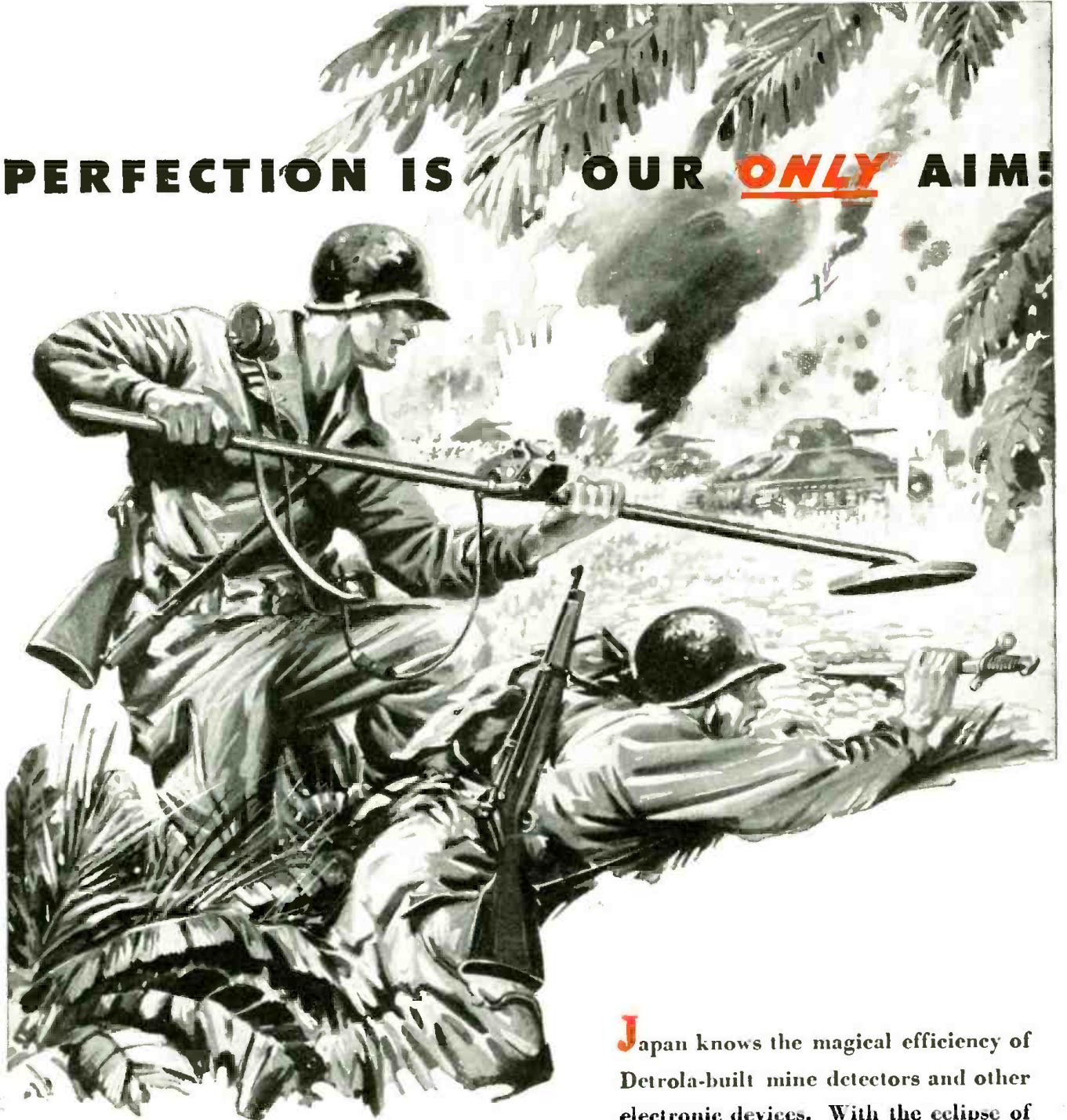

**REMEMBER AND BUY IN THE 7TH!**

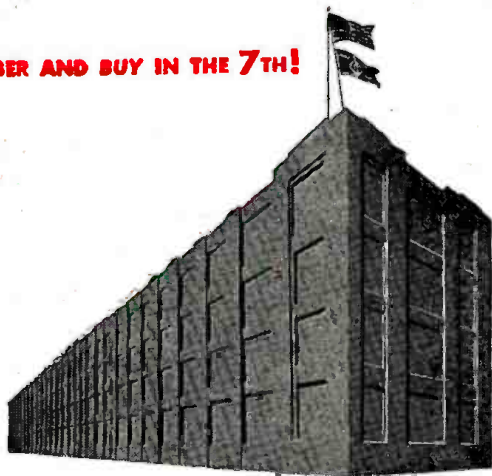

**J**apan knows the magical efficiency of Detrola-built mine detectors and other electronic devices. With the eclipse of the Rising Sun, Detrola will manufacture distinctive radio and television receivers... sturdy record changers... all of unparalleled value.

**DETROLA RADIO**

DIVISION OF INTERNATIONAL DETROLA CORPORATION  
DETROIT 9, MICHIGAN

# Centralab

## Medium Duty Power Switches

- 7½ amp. 115 V. 60 cycle A. C.
- Voltage breakdown 2500 V to ground D. C.
- Solid silver contacts
- 25,000 cycles of operation without contact failure
- Fixed stops to limit rotation
- 20° indexing

Centralab medium duty power switches are now available for transmitters (has been used up to 20 megacycles) power supply converters and for certain industrial and electronic uses.

It is indicated in applications where the average Selector Switch is not of sufficient accuracy or power rating. Its accuracy of contact is gained by a square shaft, sleeve fit rotor, and individually aligned and adjusted contacts. It is assembled in multiple gangs with shorting or non-shorting contacts. Torque can be adjusted to suit individual requirements. Furnished in 1 pole . . . 2 to 17 positions (with 18th position continuous rotation with 18th position as "off"); and 2 or 3 pole . . . 2 to 6 position including "off".

# Centralab

Division of GLOBE-UNION INC., Milwaukee

PRODUCERS OF Variable Resistors • Selector Switches • Ceramic Capacitors • Fixed and Variable • Steatite Insulators and Silver Mica Capacitors



*In  
War—  
In  
Peace.*



**RADIART VIBRATORS** (INDIVIDUALLY ENGINEERED FOR PROPER REPLACEMENT)  
**GIVE Exceptional Service!**

The high quality of RADIART VIBRATORS is well known to servicemen everywhere. That high quality has characterized all Radiart Products that have been and are being used by the Armed Forces on all fronts. As production for civilian users expands it will continue to increase the demand for RADIART VIBRATORS.

**LIMITED SUPPLY UNTIL V-J DAY**

While production for civilian users may increase gradually, by far the greater part of our production will continue to be required for U.S. Armed Forces. We must and will meet all of their schedules on time.

**FEWER VIBRATOR TYPES SIMPLIFIES STOCK PROBLEM**

By eliminating many little used types of vibrators Radiart has been able to increase production of all popular types. Now the dozen or so types of RADIART VIBRATORS necessary for over 7/8ths of all replacements are more readily obtainable.

Consult the Radiart Vibrator Catalog for complete information on all vibrators for all installations. The Radiart Line is the most complete for all replacement purposes.



**Radiart Corporation**

3571 W. 62nd STREET • CLEVELAND 2, OHIO  
 EXPORT DIVISION: 25 Warren Street • New York 7, N.Y.



# New Radio-Electronic Devices

## SEALED METERS

General Electric Co.  
Schenectady, N. Y.

**T**HIS new line of 2½-inch hermetically sealed panel instruments is housed in steel cases and immune from the effects of humidity, moisture, chemical fumes, and other harmful agents.

In obtaining a hermetically sealed enclosure, a thick, special, strain-free glass window is sealed to a metal ring, obtaining a glass-to-metal seal, and this in turn is sealed to a case by a soft-soldered joint. Hermetic sealing of the two terminal studs is obtained by a glass-to-metal seal between each metal and metal eyelet. The whole hermetic assembly is sealed to the steel base by a silver-solder operation.

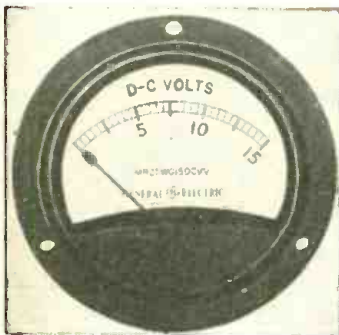

The metal base is secured to the case by means of a synthetic-rubber gasket that is coated with a special sealing compound. The seal is obtained by a crimped-over metal ring, which compresses and retains the gasket.

The final assembly is evacuated, filled with an inert gas through a seal-off tube located in the base, and is sealed off at a pressure slightly above atmospheric.

Made for flush mounting on nonmagnetic or steel panels, these new instruments incorporate the standard 2½-inch internal-pivot element in a steel case which shields them from stray magnetic fields. They are capable of withstanding a thermoshock test of at least 10 alternate exposures in salt water at 85 C and then at zero C, without evidence of moisture penetration or damage to the finish or enclosure.—*Radio-Craft*

## SIGNAL GENERATOR

Radio City Products Co.  
New York, N. Y.

**M**ODEL 704's range is from 95 kilocycles to 100 megacycles. Fundamental frequencies are continuously variable from 95 kilocycles to 25 megacycles in five bands. Calibration is accurate to 2% per band

up to the broadcast band and within 3% for high frequency bands.

Model 704 has a planetary drive condenser with direct



reading calibration. Output can be modulated or unmodulated. Self-contained modulation is either 400 cycles or 1000 cycles sine wave which modulates carrier. Either is available for external use.

Protective features of the RCP Model 704 Signal Generator are: automatic shorting of all coils not in use; individual shielding of R.F. circuits, coil assembly and attenuator; overall steel case, chassis and panel.

The five step ladder attenuator is used for controlling output. Model 704 has a convenient pilot-lite "on-off" indicator and a double-fused line cord.—*Radio-Craft*

## NEW RESISTORS

Ohmite Manufacturing Co.  
Chicago, Illinois

**T**HE Series 82 and 83 are two new precision resistors—additions to the group which now includes Series 71, 81 and 90.

The new units may be mounted by means of a through-bolt. The Riteohm 82 has two lug terminals at one end firmly fastened by screws. The Riteohm 83 has radial wire leads.

Both new units are pie-wound to 1% accuracy. Specially enameled alloy resistance wire is non-inductively pie-wound on a non-hygroscopic ceramic bobbin



which has a hole through the center for a No. 6 screw. After being wound, the units are vacuum impregnated with a special varnish which provides additional insulation and thoroughly

protects the winding against humidity. The resistors can be supplied with a varnish coating containing a fungicidal agent, thus making the units particularly suited for use in the tropics.

The Riteohm 82 is available in three sizes—11/16" diameter by 1 1/8" long, 1 7/16" long or 1 3/4" long for the 2, 4 and 8 pie units respectively. The minimum resistance is .1 ohm for all units and the maximum is 400,000 ohms for the 2 pie unit, 750,000 ohms for the 4 pie, and a resistance of 1 megohm for the 6 pie unit.

The Riteohm 83 is available in three sizes—1/2" diameter by 7/16" long, 5/8" long or 1" long. The first two units are 2 pie while the third is a 4 pie unit. The minimum resistance is 10 ohms for all units and the maximum is 200,000 ohms for the small 2 pie unit, 400,000 ohms for the large 2 pie, and 800,000 ohms for the 4 pie unit.—*Radio-Craft*

## SPECIAL METERS

Weston Electrical Instrument Corp.  
Newark, N. J.

**A**.C. electrical measuring instruments can now be furnished with special forms of compensation to maintain their accuracy over the broad fre-



quency range of from 25 to 3000 cycles, a wider range than has hitherto been obtainable.

A.C. instruments with their special compensation are widely used by the armed forces, and will prove highly advantageous to industry in those applications using power frequencies above 60 cycles, with the smaller associated transformers, higher speed motors and simpler rectifier filter systems. Not only do they afford broad measurement flexibility, but also the ruggedness and dependability of the basic moving iron vane and dynamometer type measuring instruments.

These Weston frequency compensated instruments are furnished as ammeters, voltmeters and wattmeters in both the portable and switchboard types; flat compensated up to 1000, 2000 and 3000 cycles.—*Radio-Craft*

## RAILROAD SPEAKER

Jensen Radio Mfg. Co.  
Chicago, Illinois

**T**YPE NJ-300 Reproducer was originally designed for Navy use as a loud-speaker and microphone (talk-back) but has been developed for all types of railroad use in locomotives, cabooses, signal towers, and outdoors in railroad yards.

This reproducer consists of the Type NF-300 unit enclosed in a special railroad-type cast aluminum case. It is capable of withstanding shock and vibration as well as prolonged exposure to smoke, dust and the elements.



Three holes in the base provide for mounting in any position. Provision is made for installation within the case of an hermetically sealed impedance matching transformer.

Because of case design, wind noise pick-up, when used as a microphone, shows a reduction up to 6 db as compared with the conventional type of loud-speaker. Voice coil impedance is 12 ohms nominal value; power handling capacity for speech is 10 watts.—*Radio-Craft*

## COIL DOPE

American Phenolic Corp.  
Chicago, Illinois

**A**MPHENOL Polyweld "912" is pure polystyrene in solution, adapted to "doping," coating, impregnating or sealing for very-high and ultra-high frequency as well as for general electronic applications. It will not disturb circuit constants when used on coils, ceramics, wire or insulation. Non-hygroscopic and therefore moisture-repellent, it does not normally support any fungus growth, an important point in "tropical" apparatus.

The power factor ranges from 0.00028 to 0.00033 in the frequency range .01 through 1200 megacycles and assures its low-loss qualities in that spectrum. The dielectric constant is flat through the same range.—*Radio-Craft*

# Radio-Electronic Circuits

## A NEW "MYSTERY"

Figure 1

This circuit was published, in part, in *Radio-Craft* for June 1944, Page 552, under the heading: "A Whale of a Tube."

Since that time a further study of the regenerative detector circuit, together with experimental work, have revealed some features which we think would be worth consideration.

In the first place, the tickler coil has been discarded as it was found to be of no value; but here is the feature which seems to be the real McCoy:

It is the only regenerative detector circuit which employs two tubes coupled in cascade, and for this reason both the initial signal and the regenerative branch circuit pass through two successive stages of amplification—thus placing the detector

*Radio-Craft* welcomes new and original radio or electronic circuits. Hook-ups which show no advance on or advantages over previously published circuits are not interesting to us. Send in your latest hook-ups—*Radio-Craft* will extend a one-year subscription for each one accepted. Pencil diagrams—with short descriptions of the circuit—will be acceptable, but must be clearly drawn on a good-sized sheet of paper.

circuit as a whole in the *super-regenerative* class. All other regenerative detectors employ only one tube, and must necessarily deliver lower overall performance.

The four stages of tuning shown on the schematic provide selectivity equal to that of a superhet.

This set has been in successful operation for over a year. Just how well it matches up with Armstrong's super-regenerative circuit—who can guess?

RALPH W. MARTIN,  
Los Angeles, Calif.

(A number of readers have inquired about the circuit in which the "Whale of a Tube" was used. We would like to hear what results you get with it.—*Editor*)

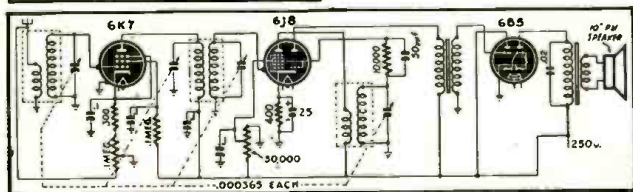
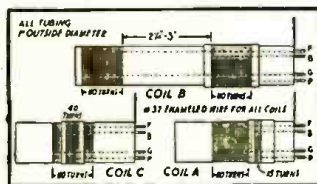

Fig. 1, above—"Mystery" Martin's latest circuit, with coil detail.

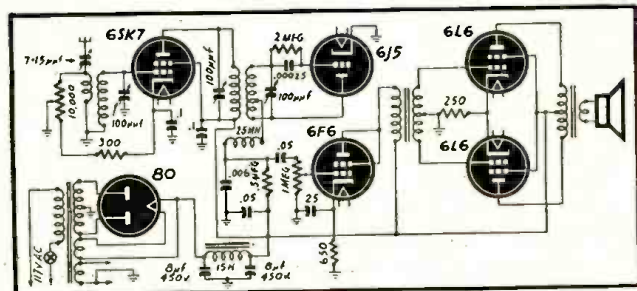

Fig. 2, above—6-tube superregen. Fig. 3, below—Converter circuit.

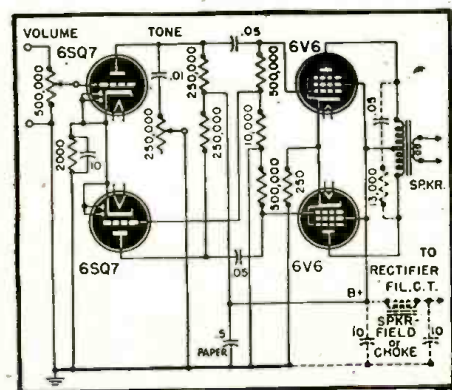
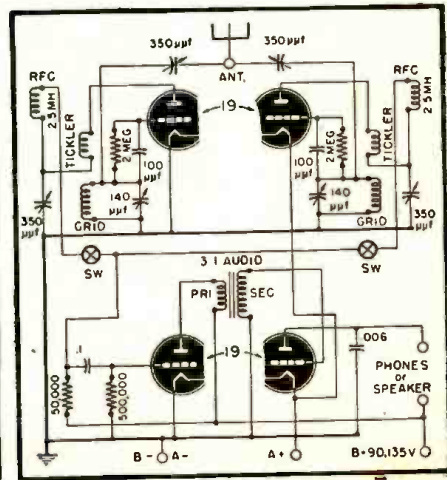
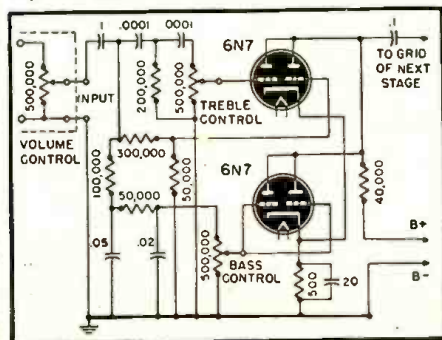

Fig. 4, below—A tone compensation circuit. Fig. 5, right—SWL radio for amateur phone.



## SUPER-REGEN

Figure 2

This powerful set has picked up stations from all over the world. I have also picked up a few FM stations.

The set itself is built in a metal cabinet and a 10 inch PM speaker is used.

The circuit is composed of an R. F. amplifier, super-regenerative detector, a driver and a push-pull output stage.

The selectivity and sensitivity is due to the novel super-regenerative detector. This circuit is unusually stable.

FRANK CHIN,  
Brooklyn, N. Y.

## PHASE INVERTER

Figure 3

I saw a phase inverter circuit in your November 1943 Question Box. A 6SQ7 was used in the so-called "kangaroo circuit." You state that it is the only inverter circuit adaptable to these tubes. This is not true.

The attached circuit is typical of one that has been used commercially by several receiver manufacturers. Used with a crystal pickup it has plenty of gain and power output. There is nothing critical in its construction to make it difficult for the home constructor. The 13,000-ohm resistor and .05 condenser across the output transformer may be dispensed with if a good output transformer and speaker are used, but may be found

valuable with such equipment as may be available today.

ROY L. GALLAGHER,  
New Kensington, Penna.

(The intention of the 1943 item was to state that the "kangaroo" was the only circuit in which one tube such as the 6SQ7 could be used to supply out-of-phase voltage to a push-pull stage. The circuit shown is a standard one in which a double triode is commonly used instead of two 6SQ7's.—*Editor*)

## STONE COMPENSATOR

Figure 4

Although this circuit uses quite a few parts, it is really worth it, as almost any desired frequency response may be obtained.

I feed this compensator into a 6N7 phase inverter and then into a pair of 6L6's. The result will please the most critical ear. The circuit forms two channels: one for highs, the other for lows and they may be combined in any proportion.

Keep all leads short and shield the longer ones. A volume control may be placed at the input to the compensator or in front of the next stage.

CPL. KURT A. MALER,  
Camp Crowder, Missouri

## 2-CHANNEL RADIO

Figure 5

Here is a novel hookup using two 19-type tubes. Note that two tuners in parallel are provided by the first tube, the second tube being two A.F. amplifiers in series.

Many uses will suggest themselves. For instance, I can tune in both sides of a plane or ship conversation, etc., by merely tuning one stage to each frequency being used. Also, I can switch into the circuit one stage only at a time.

GEORGE HIRSHFIELD,  
Brooklyn, N. Y.

## PLANNING THE SERVICE SHOP

(Continued from page 705)

a daily trip to the bank is advisable, particularly in large cities where crooks are very commonly encountered. Don't leave money lying around, nor make an obvious show of cash in dealing with the public.

Another important, but practical business point, is that of locating the cash register when you do finally acquire one. Put it in the back of the store. It is also desirable to have the counter or work bench towards the back. If the customer starts to walk out of the shop with a midget radio under his arm, without paying for the repair (or new set) the distance that must be traversed between the counter and the door will mean that a certain amount of time will be required for the crook to get out of the store. More often than not, if you look up and see the set disappearing and yell bloody murder, he will drop it like a hot cake and run. Some bartenders keep a baseball bat behind the bar, and one behind the counter is not a bad idea. In a large city especially, all kinds of screwballs are on the loose. Trust no stranger. Be gentlemanly, courteous, but firm. Watch out. In a small town, where they haven't forgotten the Ten Commandments and everyone knows everyone else, or in the suburbs of a city, the situation may be very different, and for the better.

A bell arranged to ring when the front door is opened is also another valuable and worthwhile idea. If you are selling midget sets, have the line cords *tacked down*, so that it will be somewhat difficult to remove the radios without attracting attention.

The planning of the shop will be directly related to your planned scope of activities. If you plan to sell sets as well as service, or to have booths where customers can listen to records, more space will be required. In congested city districts, space is at a premium and must be used efficiently. Rents are high. Your original service shop may evolve gradually into a shop where sales are important as well as service. In many cases sales become more important. As you gain experience in selling to the public, you can branch out and sell appliances.

A service and sales shop is shown in Fig. 1. Note that the console-type radios, which can't readily be taken out, are put up front, while the midget sets and records are towards the rear. An office communicator is used for communicating between the rear of the shop and the servicing section. Unimportant details have been omitted from the drawing. To get to the rear of the store and to buy something cheap, such as

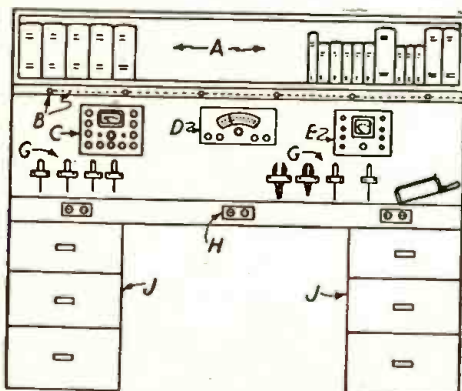

Fig. 2—A service bench. A—Books and manuals. B—Antenna jacks. C—Tube Tester. D—Signal Generator. E—Multitester. G—Loops for tools. H—Electric outlets. J—Drawers.

# SILVER Presents "VOMAX"



1. Brand new post-war design . . . positively not a "warmed-over" pre-war model.
2. More than an "electronic" voltmeter, VOMAX is a true vacuum tube voltmeter in every voltage/resistance/db. function.
3. 3 through 1200 volts d.c. full scale in 6 ranges at 50, and in 6 added ranges to 3000 volts at 125, megohms input resistance.
4. 3 through 1200 volts a.c. full scale in 6 ranges at honest effective circuit loading of 6.6 megohms and 8 mmd.
5. 0.2 through 2000 megohms in six easily read ranges.
6. -10 through +50 db. (0 db. = 1 mw. in 600 ohms) in 3 ranges.
7. 1.2 ma. through 12 amperes full scale in 6 d.c. ranges.
8. Complete signal tracing from 20 cycles through over 100 megacycles by withdrawable r.f. diode probe.
9. Absolutely stable—one zero adjustment sets all ranges. No probe shorting to set a meaningless zero which shifts as soon as probes are separated. Grid current errors completely eliminated.
10. Honest, factual accuracy:  $\pm 3\%$  on d.c.;  $\pm 5\%$  on a.c.; 20 $\mu$  through 100 megacycles;  $\pm 2\%$  of full scale,  $\pm 1\%$  of indicated resistance value.
11. Only five color-differentiated scales on  $4\frac{1}{2}$ " D'Arsonval meter for a total of 38 ranges eliminate confusion.
12. Meter 100% protected against overload burnout on volts/ohms/db.

Providing amazing advances in radio receiver servicing, VOMAX is new and fresh as today. It's not an "improved" pre-war model. VOMAX is a brand new instrument born of six years' direction of classified (secret, confidential, restricted) design and production projects for Air Corps, Army, Navy, O.S.R.D. . . . special equipments designed and produced for F.C.C., C.A.A. and other government agencies. Into it has gone the distilled genius which won Grand Prix at 1937 Paris International Exposition for McMurdo Silver for the world's best radio receiver.

That sums up VOMAX in a nutshell. It's the most complete answer to radio servicing and design ever offered . . . conceived and built by a world-famous receiver engineer specifically for receiver servicing. It starts where all competitive instruments leave off.

Deliveries begin in August upon AA-5 or higher priority. Better place your order with your jobber today to insure early delivery . . . be first to get radio's newest, most complete "service station" all in one small, easily carried instrument. By itself VOMAX is the key to service profits for you.

Possessed by no other instrument, these are features only Silver can give you — revolutionary features for others to copy.

NET PRICE **\$59.85**

McMurdo Silver Company  
1240 Main Street,  
Hartford 3, Connecticut

Please RUSH free copy of your catalog.

NAME \_\_\_\_\_  
ADDRESS \_\_\_\_\_  
CITY \_\_\_\_\_ STATE \_\_\_\_\_

OVER 34 YEARS OF RADIO ENGINEERING ACHIEVEMENT

*McMurdo Silver Company*  
1240 MAIN STREET, HARTFORD 3, CONNECTICUT

a tube, a customer must pass the console radios and midgets. In passing, his eye may be attracted to a set, and there you have a potential purchaser of a receiver.

The booth used for playing records is a very profitable addition to the shop. It should be well constructed. It is desirable to use heavy wood and sound-absorbing material. The main thing is absence of excessive reverberation and barrel effect, and exclusion of noise that may be present outside. The music lover's won't mind standing inside the cramped space of the booth; some of them seem to love it. To compensate for some of the deficiencies of the booth, the amplifier should be equipped with bass and treble controls to permit altering the tone to fit the individual's ears. A high quality heavy-duty speaker such as the Jensen 12-inch job, which will not rattle on bass, should be used. A pair of type 45 tubes in the output will give plenty of un-

distorted signal power and triodes are far better for purity of tone than harmonic-generating pentodes.

As for the service bench, every technician has his own pet ideas and the bench is usually more carefully thought out than the points mentioned above. Little will therefore be said about it. In the beginning, you may have only a volt-ohmmeter, signal generator and tube tester—the bare essentials. Later, you may add a condenser bridge, frequency modulated generator, oscilloscope and signal tracer. A convenient gadget is a wood strip about  $\frac{3}{4}$ -inch thick run across the top of the test bench. The strip has mounted on it tip jacks which are wired to the antenna. The set on the bench can then be connected to the antenna by means of a test lead which has an alligator clip on one end and a phone tip for plugging into the tip jack on the other end. A typical arrangement is shown in Fig. 2.

# TRY THIS ONE!

## POWER PACKS MODERNIZED

Figure 1

Most early all-electric receivers used separate power packs. Only a few changes need be made to apply them to up-to-date circuits using modern tubes.

The '80 socket can be replaced with a five-prong socket for a type '84. As shown in the "new" diagram, the five-volt rectifier winding is connected in series-aiding (found by trial) with a 1.5-volt winding, the total being the heater supply of all 6.3-volt tubes including rectifier. (This is also an economical method of converting auto radios.)

The second filter choke can be replaced with a speaker field. If the old set had a dynamic speaker obtaining excitation from the power pack, the speaker can still be used. It will usually be necessary to discard the

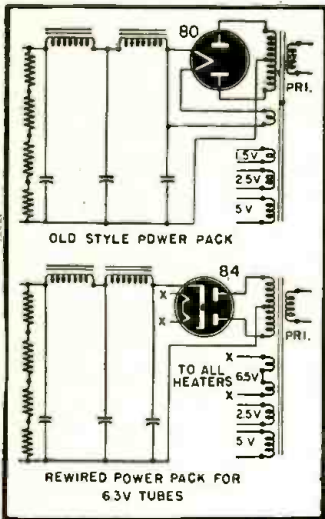

Figure 1

output transformer — usually wound for triode output tubes — and use one matched to the output tube desired and the voice-coil resistance of the speaker. If the old set had a type 47 output tube, the transformer may be suitable for modern pentodes.

With low-voltage "B" eliminators, it is possible to connect a 3000 ohm AC-DC type speaker field across the 90 volt output.

In converting auto sets, the voltage divider is left connected but its taps are disregarded. Thus only four connections between power supply and set are needed. By making common one side of the heater winding and B —, this is cut to three.

An old "B" eliminator can be used to restore operation of A.C.-D.C. sets when rectifier tubes are not available. This is especially true of 25Z5 or 25Z6 tubes which may have good

*Radio-Craft* wants original kinks from its readers, and will award a seven-month subscription for each one published. To be accepted, ideas must be new and useful. Send your pet short-cut or new idea in today!

heaters but open cathodes. Leave the tubes in the set to complete the heater circuit and connect the cathodes to the 90-volt tap. If the rectifier was used as a voltage-doubler use the 180 volt tap. If the tube heater is open, bridge the ends with a resistor of proper value, or simply short them, disconnect the heater series resistor and replace with a suitable lamp bulb.

E. E. YOUNGKIN,  
Altoona, Pa.

## SLIPPING DIALS

In the majority of sets manufactured during the past ten years, the method of moving a dial pointer in concordance with the tuning condenser has invariably been by means of a dial cord or cable.

Eventually the cord loosens or expands sufficiently so that the condenser moves but not the pointer.

Here is a remedy for that condition. Prepare a solution of gasoline and resin. Brush this on the cord, revolving the dial as you do so. The gasoline will evaporate and leave the resin in the cable, which in average cases is sufficiently frictional to do the trick.

ANDY R. HARCAR, JR.,  
Birdsboro, Pa.

(Transformer oil and resin has also been used with excellent effect.—*Editor*)

## COIL WINDER

Figure 2

Here is a simple jig for coil winding that can be easily attached to the flywheel of a sewing machine. The author has wound power and output transformers quite satisfactorily with it.

Two stove bolts form the means of fastening the board to the flywheel. The board used was 6 x 6 x 3/4 inches, but this will vary with the machine used. If possible, the bolts can also be used to prevent the shuttle clutch from locking so that the sewing mechanism is inoperative.

Various sizes of cores may be accommodated by varying the size of the block A, which is fastened to the jig by the screw. Spring clip B is necessary to hold the bobbin securely.

For counting the turns, the shuttle winding mechanism of

the machine is useful. It frequently has a reciprocating arm to help in threading the bobbin evenly, which moves back and forth slowly. On this particular

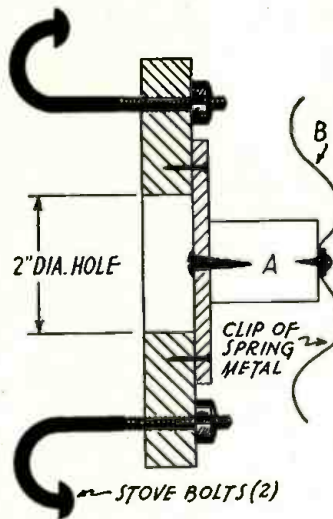

Figure 2

machine, the author used one complete cycle of this arm to correspond to 36 turns of the flywheel. Counting the number of turns was thus easily accomplished.

ALLEN W. JACKSON,  
Edmonton, Alta.

## SOLDERING IRON

Figure 3

Finding trouble in locating a good 32-volt soldering iron, I decided to construct one. I had on hand a burned out iron, and had to make a 32-volt element for it. I chose a length of a 110-volt hot-plate element which would make a bright-red glow on 32 volts. If the wire should become uncoiled, recoil it tightly on a 1/8-inch rod. One end is unwound for about 2 inches, and the other end long enough to come back along the coil. Leads are then connected to the ends.

I used mica to insulate the

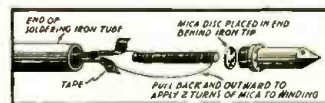

Figure 3

wires, having nothing better on hand. Tape covers the splices, and the mica (of medium thickness and 3 inches

longer than the element) is wrapped around the complete element. The mica may first be rolled over a pencil, making it easier to handle. Two mica layers are wrapped around the element, then between the leads and then around the whole assembly. A mica disc at the end of the tube prevents shorts effectively.

HOWARD F. BOYLE,  
Vivian, S. D.

## LOCTAL PLUGS

Servicemen and experimenters have been making plugs from tube bases for years, but when it comes to loctal tubes it is hard to tell where tube stops and base begins. I have devised the following method:

Take a three-cornered file and make a scratch all the way around the glass at the top of the metal band. About the second time around the glass will part. Cut off the tube elements and brighten the tops of the pins. (A small flat ignition file is best for this.) Leads can then be soldered to the pins after forming small loops to fit them.

If unable to obtain 35A5 tubes, late A.C.-D.C. sets may be combined with the audio of an older set. Make a loctal plug from the old tube. Connect heater pins to a 250-ohm resistor, grid pin with shielded lead to audio input of old set, and chassis (through .1 MFD) to chassis of old receiver. This method may be applied to a tuner for a P.A. system.

E. E. YOUNGKIN,  
Altoona, Penn.

## CHASSIS HOLDER

Figure 4

With the use of four "C" clamps, repair and adjustment of automatic record changers and similar chassis may be made more conveniently.

The clamps are adjusted so



Figure 4

that the work will sit up level on the work bench. If desired, a modification may be made, consisting of an extended rod which may be welded to each clamp. It is often desirable to terminate the rod in a washer as shown in the sketch.

G. L. MORRIS,  
Vincennes, Ind.

## WATER RHEOSTAT

Did you ever have need for a particular source of voltage and have to fuss for hours with combinations of various resistors only to find out that you can obtain merely a reasonably fair approximation? If you did, here's a real time saver for you. The hook-up is simplicity itself. All that is needed is a board and a tumbler.

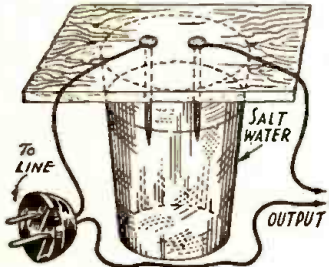

Drive two large nails (or screws) through the board about one inch apart. Connect one side of the line to one of the nails. Then connect a wire to the other nail. Place the board over the glass of water and add a few grains of salt to the water. If a voltmeter is available, connect it to the load side of the line and to the wire fastened to the second nail. Now adjust the rheostat by adding salt until the desired voltage is obtained. If you find that you cannot reach the desired voltage, try using a larger glass and add more salt. (The average glass will not deliver more than six volts and the water will get unduly hot.)

OLLIE PEOPLES,  
Mountain View, Okla.

## BOTTLE LEGS

Don't, Mr. Serviceman, throw away those old bottles! Here is an excellent way to make them give extra service in the repair shop.

If you have ever had to work on an automatic changer you know how they can cut up your bench, how they start to walk away from you when you set them in operation, how delicate bars and pinions can get damaged and how difficult it is to observe the operation of the changer. Now all four of those troubles can be eliminated by merely drafting four large-bottomed narrow-necked bottles.

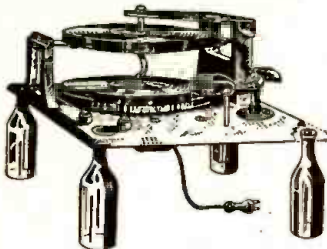

Simply place one bottle in each corner of the changer as a support and your problem's solved. Occasionally, this can also be used to support radio chassis, but it might turn out to be too unsteady.

PFC. JOE GIANNELLI,  
Langley Field, Va.

## HANDY TOOL TRAY

The tool tray illustrated is the one found in the usual metal tool box.

By constructing a "goose neck" from standard plumbing fittings the tray can be kept off the Serviceman's work bench and, yet, can be replaced in the box for outside jobs. Constant transfer of small tools from one container to another is thus eliminated.

One-half- or three-quarter-inch water pipe sizes will serve for the plumbing fittings required. These parts are commonly used and can be obtained either from your local plumber or from the local hardware and plumbing supply store.

"A" is a base used for attachment to wood. Two are required. "B" is a Street Elbow. Two required. "C" is an Elbow. Two required. "D" is a six-inch length of pipe threaded at each end. It comes in stock at this length, threaded as specified. Three required.

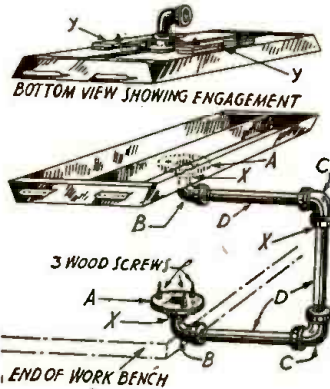

Parts should be joined together tightly, except at the three points marked "X" on the illustration. These points must be a little loose to allow for easy swing. The weight of the tray will hold the rig firm.

At points "Y," tracks (grooves), are required to engage the inverted base. These can be made as shown from any available metal strips, or Bakelite. Standard radio bolts (6-32), will be strong enough.

WILLIAM LYON  
Mamaroneck, New York

## BLARE KILLER

If you have ever had the annoying experience of rushing to the telephone only to discover that you can't hear a thing because the radio is blasting away, you can appreciate the usefulness of this kink.

Solder two leads to the output transformer terminals on the speaker frame (the leads to the speaker voice coil) and extend them to a point near the phone. Connect a small switch across these leads.

Now you are ready to control the radio from your position at the phone and no one can turn the radio on or increase the volume without your permission.

BEN SHAVER, JR.,  
No Address

**LEO'S SPECIAL!**



Quality Test Leads for this Unit 60c

Immediate Delivery!

MONEY BACK GUARANTEE! ON THIS ALL-PURPOSE

## MULTITESTER

Handles AC and DC Voltmeter, DC Milliammeter, High and Low range Ohmmeter. Overall size, 5 1/2 x 8 x 3 1/4 inches. Meter is round bakelite case with sturdy D'Aronson movement. Write for priority information today!

Model WRL 300 ONLY \$18.75 Less Leads

SEE LEO FOR QUALITY WRL RADIO KITS! PRIORITY REQUIRED

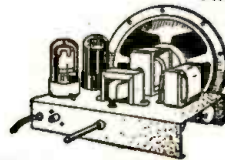

## PHONO AMPLIFIER KITS

Complete with tubes, speaker, resistors, condensers, and instructions, No. 1059... \$9.50

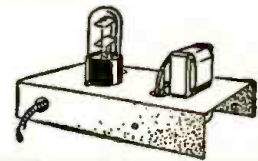

## CODE OSCILLATOR KITS

Complete with tube, circuit diagram, instructions. Easy to assemble. 3"x6". No. 66-200... \$4.95

## WE SPECIALIZE IN HALLICRAFTERS

"The Radio man's Radio"

We are one of the nation's largest distributors of HALLICRAFTERS. Available for immediate delivery on priority. Write for details today!

## QUICK SERVICE

"Same Day" delivery service from the heart of the nation... on everything in radio! We've remodeled our store, doubled our shelf space, and increased our stock many times. Thousands of hard-to-get items are now available to new and old customers. Write today. You'll like our quick, personal service.

Sincerely,  
Leo S. Meyerson



## WHOLESALE RADIO LABORATORIES

744 West Broadway  
Council Bluffs, Iowa



Frederick  
NEW PARTS FLYER

44 pages packed with hard-to-get radio parts... all in stock for immediate delivery to radio repairmen. Usual priorities apply. Experimenters write Leo, W9GFQ for details on how to get radio repair parts.  
Tube and Circuit Reference Book... .10c  
Tube substitution data; technical data.  
Handy Tube-Base Calculator... .25c  
Shows tube characteristics which enable you to substitute available tubes for those hard to get.  
Giant Radio Reference Map... .15c



Time zones, amateur zones, short wave stations, etc.  
Size 3 1/2 by 4 1/2 feet.

## MAIL TODAY

Wholesale Radio Laboratories  
744 West Broadway RC-8  
Council Bluffs, Iowa.  
 Please rush Multitester No. 300. \$18.75 is enclosed, or Enclosed is \$\_\_\_\_\_, Balance C.O.D.  
 Send your reference Book "Tubes and Circuits." Here's my 10c.  
 You bet I want a Tube-Base Calculator. 25c is enclosed.  
 Ship me your radio map. 15c is enclosed for packaging and mailing.  
 Send your free flyer of hard-to-get radio parts.

Name \_\_\_\_\_  
Address \_\_\_\_\_  
Town \_\_\_\_\_ State \_\_\_\_\_  
I am  an amateur;  experimenter;  service man.

different frequencies, self-generated oscillations cannot be set up. This also makes shielding entirely unnecessary.

### A REAL ONE-CONTROL RECEIVER

The object of the second receiver, designed by Harvey Kees of Evansville, Indiana, is to cover a wide range of frequencies without using tapped or interchangeable coils. The entire spectrum from 100 to 1750 Kc is covered with a 100-mmf tuning condenser, assisted by a 25-mmf "bandspreader" across it. There are no ganged tuning controls. The oscillator condenser (see schematic, Fig. 2) alone is tuned. It varies the oscillator frequency from 2,100 to 3,750 Kc to produce a 2,000-Kc I.F. over the entire tuning range. It is this high I.F. that makes the wide tuning range possible.

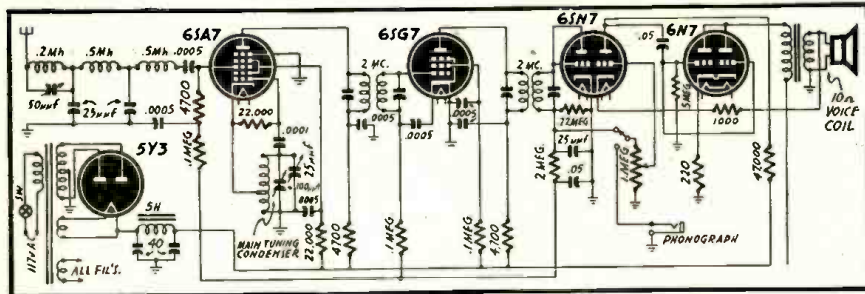

Fig. 2—This superheterodyne covers the 100- to 1750-Kc range with only one tuning control.

To tune from 500 to 1750 Kc with an ordinary receiver requires that the oscillator frequency be varied from about 1,000 to 2,200 Kc, a range of somewhat more than 2 to 1. The 100-mmf condenser across a small inductor will tune readily from 2,100 to 3,750 Kc, a range less than 2 to 1.

As may be seen from the schematic, the

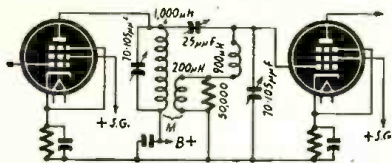

Fig. 3—An infinite-rejection tuning circuit.

input circuit is simply a low-pass filter, admitting all signals below 1750 Kc and shutting off all above that frequency. The high intermediate frequency prevents image interference, even with the untuned input circuit; when the set is tuned to its lowest frequency—100 Kc—the image is 4100 Kc, well above the cut-off point. Since only the I.F. circuit selectivity is effective against adjacent-channel interference, some trouble might be expected tuning in weak stations not far removed from powerful ones.

The present model is not adapted to the needs of short-wave enthusiasts, who are the ones most concerned about band-switching. A receiver with a much higher intermediate frequency—in the order of 20 Mc (20,000 Kc) could cover the whole range from 100 to 15,000 Kc.

Mr. Kees has drawn up tentative plans for such a set adapted both to FM and AM reception, with a 20-Mc amplifier. A second I.F. amplifier at 500 Kc would pro-

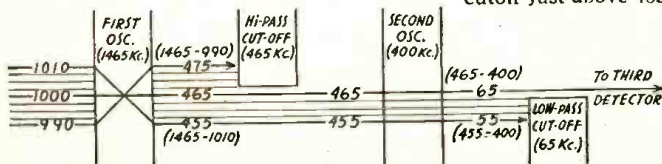

Fig. 4—Path of signals through the Griffin receiver's channels. Fig. 5, right—Hookup of the most essential parts of the circuit.

## NEW IDEAS IN RECEIVERS

(Continued from page 695)

vide additional selectivity and a special bandspread for AM signals. So far, the wide-range receiver is entirely in the experimental stage—construction of only two sets having been reported.

### A COMMUNICATIONS RECEIVER

Third is a triple-detection circuit which features a variable-width intermediate frequency which can be widened out to super-high-fidelity or closed to crystal-filter characteristics. It also provides for audio modulation of C.W. (continuous-wave) signals.

The 465-Kc signal and a band of frequencies just below it pass on to the next detector and oscillator, which may be set at a frequency below the I.F.—say 400 Kc. The 465-Kc signal will now be transformed to 65 and the 455-Kc signal to 55 Kc. Note that no signal above 65 Kc exists, having been cut off by the first infinite-attenuator.

The signals now pass the second infinite-attenuation system, set to cut off frequencies below 65 Kc. The original 1000-Kc signal will pass but the 1010-Kc signal (now 55-Kc) will be stopped. Frequencies within a kilocycle or so of the 65-Kc I.F. frequency are passed to the third detector, to be rectified and amplified in the usual way.

Most important feature of the new receiver—this band of "a kilocycle or so" may be narrowed to zero or widened out to satisfy the demands of high-fidelity reception simply by varying the second oscillator over a few kilocycles. Should its frequency be lowered to 390 Kc, the difference between it and the 465-Kc signal entering the second mixer would become 75 Kc. We now have a 10-Kc bandpass, and a little re-tuning of the input circuits (which include the first oscillator) would put the 1000-Kc signal right in the middle of it, while the 1010-Kc station would be cut out by the low-side rejection circuit.

If the second oscillator were tuned slightly above 400 Kc, no signals whatever would reach the final detector, as no frequency higher than 465 reaches the second oscillator, and the difference frequency between the oscillator and any frequencies that do arrive would be less than the 65-Kc cutoff. The band to be passed can thus be cut down to crystal-filter width, with the advantage that the sides of the selectivity curve are straighter than in a crystal circuit, and the objectionable "pinging" due to the high Q of crystal circuits is absent.

The band can also be widened out from zero to any extent required for a given type of reception. Thus phone can be received on a band a few hundred kilocycles wide—sufficient for intelligibility but narrow enough to cut out interference which cannot be rejected by conventional circuits. The band can be narrowed or widened during reception of a transmission if required, with only the necessity of slight retuning of the input circuits whenever its width is changed.

By frequency-modulating the second oscillator, it can be made to impress an audio modulation on C. W. signals. This is done by varying its frequency at an audio rate sufficiently to cut off the signal (reduce the band-width to less than zero) at extremes of oscillator swing. This is actually an electronic chopper, similar in effect to those which used to be common in I.C.W. transmitters.

This chopper method of making C. W. signals audible is claimed by the inventor to be a considerable improvement over the beat-frequency oscillator, whose tendencies toward lock-in and drift are well known.

Fig. 5 shows a schematic of the essential parts of the receiver.

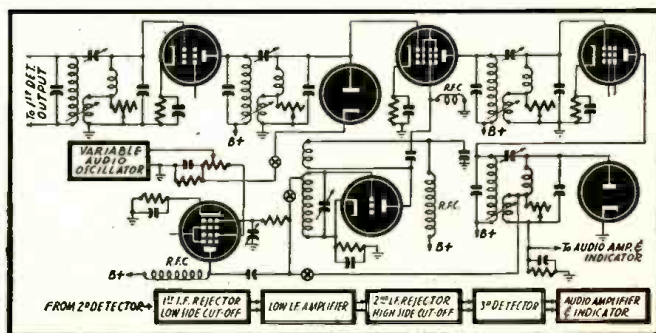

## RADIO VOLTAGE TESTS

(Continued from page 706)

or is not properly connected due to a poor soldered joint.

If voltage is obtained between plate and ground, but not between plate and cathode, an open in R3 may be the trouble. Either a new resistor can be tried or an ohmmeter-measurement to check the resistance taken.

If there was no plate voltage on VT-1 the trouble might be an open in R1 or a lower than normal resistance between the plate and B-minus, due to a breakdown in a condenser connected between those points or a short in the wiring.

The basic circuit of a full-wave rectifier arrangement is shown in Fig. 5. A common mistake that many beginners make in checking this circuit is to connect a D.C. voltmeter to the rectifier plate (either one) and the rectifier filament. The location of the meters for voltmeter tests is indicated directly on the diagram. A serviceman would use rapid point-to-point analysis in checking such a circuit. Note that the rectifier filament circuit is at a high voltage with reference to ground. The voltage in a typical case might be anywhere from 200 to as high as 400 or 500 volts, depending on the type of radio in question.

The D.C. voltage developed across a resistor connected between the center tap of the high-voltage winding and ground may be used for biasing an output tube or other tubes in the receiver. The D.C. voltmeter is connected to check that voltage as indicated on the diagram. The electron flow is from the centertap to ground and the polarity indicated must be observed—otherwise a reverse indication on the meter will be obtained.

If there is a very high voltage across R1 the trouble may be that the resistor is open, burned out, or that the load has been disconnected. If the resistor appears to have been overheated the trouble may be due to a breakdown in C2. The voltage across the output can be checked with C2 in and out of the circuit. If, with the condenser out, the D.C. voltage comes up greatly, the defect in C2 is obvious and a new condenser can be installed.

Should there be no voltage at the output, a break in L1 may be responsible. Usually there will be a voltage drop of the order of 80 to 110 across L1, which may be the field coil of a loud-speaker. This varies according to the set and the resistance may be that of a choke or a speaker field. Low-resistance chokes having low voltage drops are used in some radios.

If no voltage output across C1 is obtained and the leakage and circuit resistances appear to be normal, the trouble may be weak emission or no emission at all in the rectifier—assuming that there is voltage across L3 and L4. An open in the filament circuit of the rectifier tube could also cause the trouble.

Still another type of power supply is that found in auto radios using synchronous vibrators. The D.C. voltage output may be checked by connecting a D.C. voltmeter to the centertap of the high-voltage secondary and ground. If no output voltage is obtained, the trouble may be due to a breakdown in the buffer condensers (a rather common fault) or to failure of the electrolytics. In some cases a new vibrator will be required, but before a vibrator is installed the circuit should be carefully checked to make certain that any defects which can be cleared are removed. Otherwise, installation of a new vibrator may result only in damage to that vibrator and

## PORTABLE POWER PROBLEMS

THIS MONTH—THE SOUND-LEVEL METER

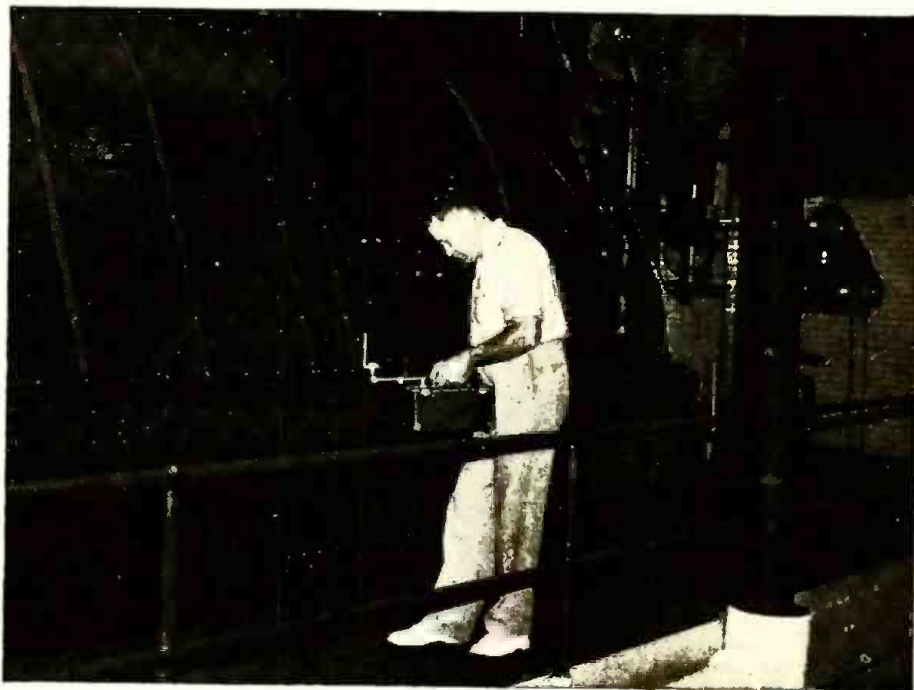

**BURGESS INDUSTRIAL BATTERIES** meet every power requirement for the conveniently portable sound-level meter. Used for qualitative measurement of sound, the meter consists essentially of a sound pickup, a special electronic amplifier and an indicating instrument. Burgess Industrial Batteries give dependable, long service life in hundreds of electronic industrial applications.

**ENGINEERS CHOOSE BURGESS** Industrial Batteries for the operation of portable instruments—recent surveys of dry battery preferences reveal that Burgess is the first choice of electronic experts! Burgess engineers will develop batteries for any special problem you may have, although most needs can be served from the standard line available through your Burgess distributor. *Burgess Battery Company, Freeport, Illinois.*

CAREFUL BUYING KEEPS PRICES DOWN!



# BURGESS BATTERIES

VOTED FIRST BY ENGINEERS IN NATION-WIDE INDUSTRIAL BATTERY SURVEY

not restoration to normal of the circuit performance.

In any event, the basic idea of keeping in mind the plate-cathode of a tube, or screen grid-cathode, as a resistance equivalent to a load R<sub>1</sub> and then visualizing a series resistance between that load and the source of voltage will be handy and helpful in servicing. If you don't have voltage across the load, look for a lower than normal resistance across the load, an increased resistance between the load and the source, or a defect in the source itself.

Savings of 20 to 40 percent in size of postwar radio receivers, television and FM sets, are expected to result from the use of miniature tubes of the type now being manufactured for the armed services.

### NEW RADIO BOMB CONTROL

Now that United Nations experts are studying the Nazi radio-controlled "V-weapons" in their own factories, many fantastic rumors on their construction and control may shortly be exploded as a result of their investigations.

One of the most pleasing—if not most authentic—of these comes from the underground Norwegian newspaper, *Vaart Land* (Our Land). That paper stated: "It is rumored that all the sets confiscated in Norway have been removed to Germany for incorporation in the German V-1. They are particularly suitable for this purpose as they are all without exception tuned to London."

(The story was broadcast—with no small amount of relish—on a recent BBC program.)



**WILL YOU BE READY? CREI Can Prepare You Now for a Better Job and a Secure Post-War Career in RADIO-ELECTRONICS**

**CREI Technical Home Study Training Prepares You for the Secure Radio Jobs that Pay Good Money for Ability—**

You can be ready to enjoy the security of an important engineering position and take advantage of new career opportunities . . . if you prepare yourself now.

Join the ambitious radiomen who are assuring themselves of secure good-paying jobs with a planned program of advancement made possible by CREI home study training in Practical Radio-Electronics Engineering.

You can study at home—in your spare time—develop your technical ability—increase your knowledge to keep pace with important developments now taking place in the industry.

CREI home study courses are constantly being revised and kept up-to-date with the rapid developments in the industry. What do you know today about U.H.F. circuits, cavity resonators, wave guides, Klystrons, Magnetrons and other tubes? U.H.F. as well as all other basic principles of modern, practical radio electronics engineering are covered in CREI home study courses.

When the war is over, the good jobs will go to the "survival of the fittest," so make sure that you will not be left behind. Get ready now, for a secure job in the coming new world of Electronics.

**● WRITE FOR NEW, FREE 36-PAGE BOOKLET**

If you have had professional or amateur radio experience and want to make more money—let us help you qualify for a better radio job. TELL US ABOUT YOURSELF, so we can intelligently plan a course best suited for your needs.—PLEASE STATE BRIEFLY YOUR BACKGROUND OF EXPERIENCE, EDUCATION AND PRESENT POSITION.



**CAPITOL RADIO ENGINEERING INSTITUTE**

Home Study Courses in Practical Radio-Electronics Engineering for Professional Self-Improvement

Dept. RC-8, 3224—16th St., N. W. WASHINGTON 10, D. C.

Contractors to U.S. Navy—U.S. Coast Guard—Canadian Broadcasting Corp.—Producers of Well-trained Technical Radiomen for Industry

# Progress In Invention

Conducted by I. QUEEN

## FM-AM RECEIVER

Murray G. Crosby, Riverhead, N. Y.  
Patent No. 2,363,650

THE ordinary resonance curve of an I.F. amplifier introduces AM so that a limiter is required for FM reception. Here the usual discriminator is modified by adjustment of M, C, R1 and R2 to obtain excessive selectivity, its curve drooping near the carrier. The decrease near this frequency is compensated by the usual increase of the resonance curve, resulting in a linear discriminator curve without a limiter stage.

AM may also be received as shown. Here the output is the sum of voltages across R5 and R4 which are in phase. The output will be a double-humped voltage of the same polarity on each side of the carrier. When combined with the above-mentioned resonance curve the result is a desired flat top.

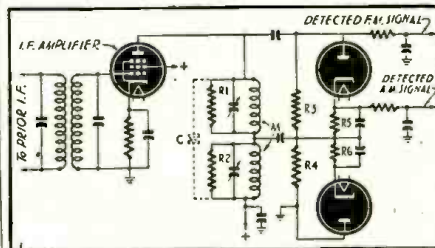

## TUNED LOOP ANTENNA

Harry E. Thomas, Haddonfield, N. J.  
Patent No. 2,373,206

LOOP aerials provide compact sources of energy pickup, but heretofore there has been no effective way of tuning the loop to fully cover the broadcast band. An inductance tuning ratio of 10-1 would be required for this purpose. The elimination of tuning condensers would permit a more compact and economical input circuit.

The accompanying diagrams illustrate a new means of tuning a loop with an inductance change ratio of about 10-1. Four similar loops are wound in the same direction and mounted on a collapsible, hinged body. For clarity only a single turn is shown on each side. When fully open (full lines) the total inductance is due to the self-inductance of each side plus the mutual inductance effects of opposite sides which are seen to aid. As the sides collapse, (dotted lines), note that adjacent sides approach. Since the latter effects oppose, the resultant inductance approaches a very small value.

The quadruple loop is in effect a special application of the variometer principle used in the tuning circuits of many early broadcast radio receivers.

Any gear system which eliminates backlash may be used as a control.

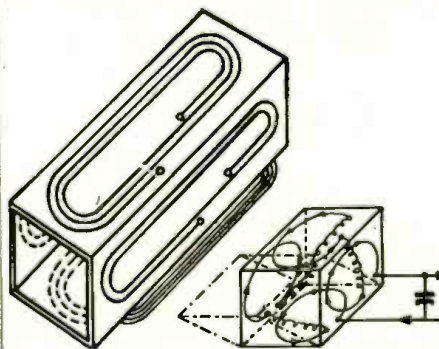

## HIGH-VOLTAGE GENERATOR

Otto H. Schade, W. Caldwell, N. J.  
Patent No. 2,374,781

WHERE high voltages at low currents are required, as in television circuits, it is desirable to eliminate transformers because of their great weight and bulk. An R.F. oscillator and rectifier

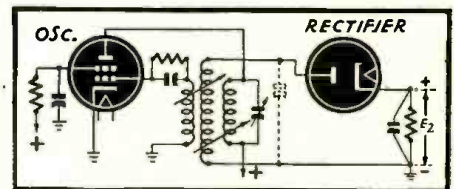

Above:  
Fig. 1

Right:  
Fig. 2

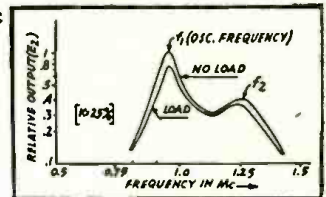

system can be used not only for the above reasons but also because of its greater safety, since it has a current-limiting characteristic.

A voltage step-up R.F. transformer having a Q of about 150-300 steps up the high frequency (about 1 Mc.) to a high voltage (up to 75,000). A 6Y6 oscillator, for example, can generate about 15 watts at 75% efficiency using 300 volts on its plate. By using tight coupling, and tuning the oscillator to the lower of the two resulting peaks, a voltage regulation of between 5 and 15% may be obtained (Fig. 2).

## SAWTOOTH GENERATOR

Thomas W. Cunniff, Newark, N. J.  
Patent No. 2,374,666

THIS novel electron tube simplifies and improves the generation of sawtooth wave forms. It consists of an electron gun A, a beam deflecting system B and a target C. The latter is seen to be an annular coating of resistance material (such as carbon sprayed on to a mica disc) with a small gap.

A sine wave of desired frequency is applied to the tube. A phase-changing circuit applies voltage to the two sets of plates 90° out of phase with each other, causing the beam to travel in a circle along the target.

The output voltage at DE is seen to be in series with a portion of the target PD (P being the point at which the electron beam strikes the target at the moment). The greater the length PD, the smaller the output voltage becomes. Therefore, when P is in the gap, the output voltage is zero and it becomes progressively greater as P moves in the direction of the arrows. The small figure shows the wave form. Note that no time is wasted since the voltage drops immediately to zero at the gap. Dotted lines show ordinary sawtooth waves.

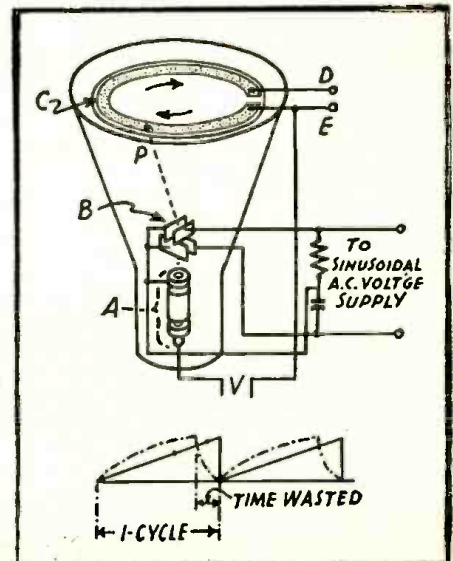



## MICROWAVES

(Continued from page 698)

tween the two magnetron sections interacts on the electrons in such a manner that they move spirally, as shown in Fig. 5-c. There are several methods of producing oscillations with the magnetrons, but since the field is so large, only the transit-time method will be considered here. It is the method most nearly like that previously described for the Barkhausen-Kurz oscillator. Assume that we have a split-anode magnetron, as in Fig. 6, with an A.C. voltage applied between the segments.

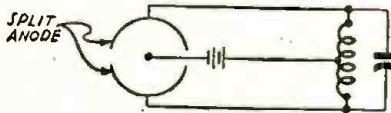

Fig. 6—A magnetron of the split-anode type.

Those electrons which leave the cathode and strike the plate give up energy to the A.C. source applied to it. Those which return to the cathode give up energy to it which was extracted from the A.C. plate source. In order that the oscillations be sustained, it is necessary that more energy be given up to the A.C. source than taken from it, as this A.C. source is actually the tuned circuit. Electron velocities are increased and decreased by the A.C. source in the magnetron in the same manner as in the B-K circuit, and the energy extractions and deliveries are the same.

Therefore, it may be seen that the ideal situation is for the electron to make several oscillations and eventually land on the plate. This is accomplished in two manners. The first is to tilt the magnetic field at an angle not exceeding 10 degrees. This gives the electron a helical path, ending on the plate. The other method is to put end plates on the cylinder, so that the effect is the same.

Magnetrons have many applications in the microwave field, and the developments have gone much further than security regulations will permit discussion of. They are used to produce the shortest sustained oscillations yet attained, with wave lengths down to less than 1 centimeter in length.

END OF PART II

## WE MAKE 'EM PLAY

FROM the title, the readers will think this is just another mess of hot air on what tubes will replace the ones we all dream about having by the hundreds, such as 12SA7's, etc. But wake up, Servicemen, throw your brains into high gear and focus your photo-electric eyes on your tube shelf. Do you see any 6SA7's? Well, pull 'em off the shelf and place them on your bench. Now drag over to the bench about 50 of the 100 sets waiting for 12SA7's, heat up your iron and roll up your sleeves. Don't

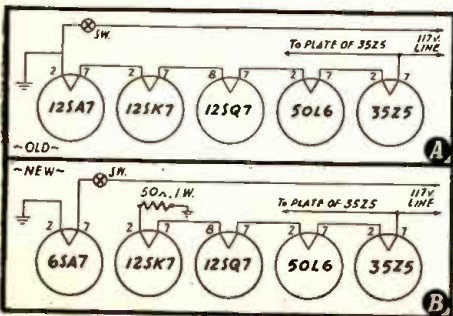

RADIO-CRAFT for AUGUST, 1945

ALL THE

# Stability

THE NAME IMPLIES

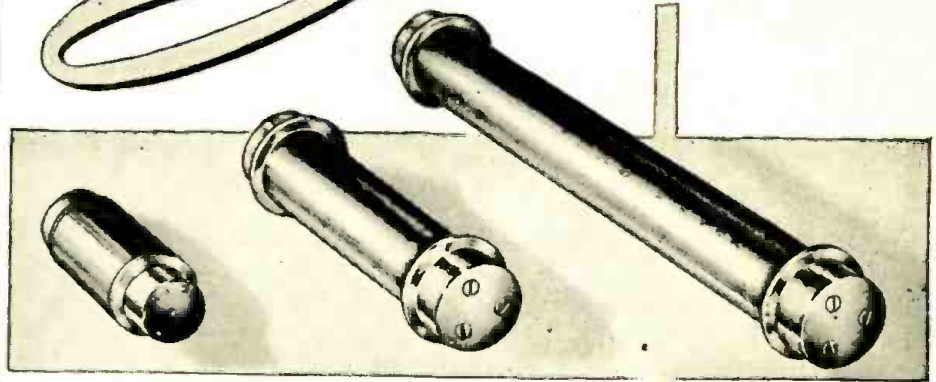

## WESTON TUBULAR RESISTORS

WESTON tubular resistors . . . widely used since their introduction over a decade ago . . . furnish another outstanding example of sound engineering coupled with engineering foresight. For no new 'hurried' resistor design was needed in order to meet exacting military specifications that called for protection against tropical humidity, arctic and high working temperatures, and salt air. The WESTON tubular resistor met these new specifications . . . and in a rugged, non-fragile design tried and proved throughout the years. These resistors conform to and are approved under joint Army Navy Spec. JAN-R-29. Bulletin A-12 gives complete specifications. Send for your copy . . . Weston Electrical Instrument Corp., 599 Frelinghuysen Ave., Newark 5, N. J.

# Weston Instruments

Albany • Atlanta • Boston • Buffalo • Chicago • Cincinnati • Cleveland • Dallas • Denver • Detroit • Jacksonville • Knoxville • Los Angeles • Meriden  
Minneapolis • Newark • New Orleans • New York • Philadelphia • Phoenix • Pittsburgh • Rochester • San Francisco • Seattle • St. Louis • Syracuse  
In Canada, Northern Electric Co., Ltd., Powerlite Devices, Ltd.

bother about sockets, you won't need them.

Look at Fig. A. Remove the wires on pins No. 2 and No. 7 of the 12SA7 and slap a 50 ohm, 1 watt resistor across the terminals. You now have the rest of the tubes in series with the resistor instead of the 12SA7 socket. Then look at the power switch on the volume control. Nine times out of ten it is grounded, so break this lead and connect in the 12SA7 (I mean 6SA7) socket (Fig. B).

What happens is this: when the tubes warm up and draw current, the 6SA7 will light because it is in series with the complete load, that is, heaters and rectifier. The total is about 260 mils, so the 6SA7 should have a long life.

I first tried this trick about 8 months ago and the set is still in operation. Since then I have changed about 450 sets and all work satisfactorily. About a week after the first

change, I thought, "By heck, if a 6SA7 works that way for a 12SA7, so will a 6SK7 for a 12SK7, a 6SQ7 for a 12SQ7, etc." I tried them, and sure enough they do work.

Use a NEW TUBE, though. I haven't tried a used one yet and I'm not going to. I advise anyone trying this system to stay as far as they can from so-called "good used tubes." It might be a good idea to use a 1-amp. fuse in the circuit in case a short develops between cathode and heater.

TUNIS NUNAMATTU  
Portsmouth, Ohio

A survey made for the Canadian Radio Manufacturers Association, reveals that only 5% of Canada's radios are out of order. This, reports the Association, reflects particular credit on the radio men of the country, in view of the severe parts shortage.

# OHMITE RESISTORS

for accurate  
trouble-free  
SERVICE

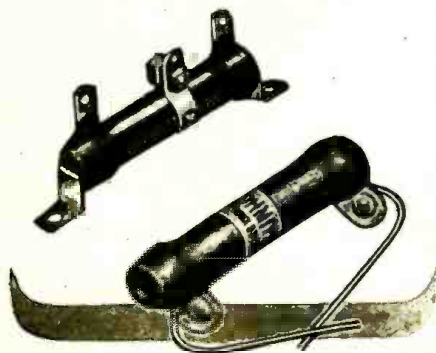

Time-proved, battle-proved, service-proved... Ohmite Brown Devils and Adjustable Divid-ohms are used today in critical war equipment. After Victory . . . these dependable units will again be the favorite of radio servicemen who want and use the best for resistor replacements.

For information about these and other Ohmite Resistors, write for Stock Unit Catalog 18.

## SEND FOR HANDY OHM'S LAW CALCULATOR

Figures ohms, watts, volts, amperes—quickly, accurately. Solves any Ohm's Law problem with one setting of the slide. Send only 10c in coin for handling and mailing. (Also available in quantities.)



OHMITE MANUFACTURING CO.  
4894 Flournoy Street • Chicago 44, U.S.A.

Be Right with **OHMITE**  
RHEOSTATS • RESISTORS • TAP SWITCHES

# Unbalanced-Bridge Checker

RESISTANCE and continuity measurements are not new in radio servicing. Here is a professional tester which was designed for quick and simple operation of production units and which contains a number of unusual features. It was designed by Glenn L. Martin Co. engineers for the testing of communications systems in Martin electric turrets. It has

voltage causes firing of the second thyatron and again the red light flashes on. The meter is protected both by a shorting of its terminals and by the addition of a high resistance in series with it, when this happens.

An unusual 6J5 circuit is provided for additional protection. If the tester should be operated before the thyratrons become

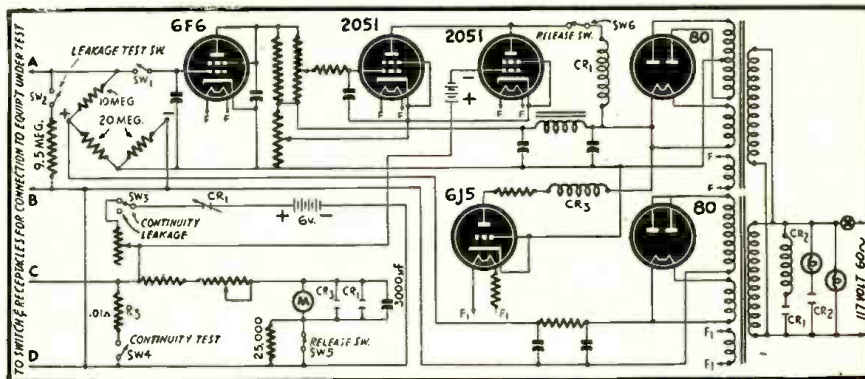

resulted in great speeding up of war production and the saving of time and labor.

The circuit is interesting to technicians because of two features. One of these is the unbalanced bridge used in certain checks. The other is the use of the thyatron tube in a piece of test equipment.

Two extremes of resistance measurements are provided for. One is insulation resistance in the neighborhood of 100 megohms, the other is a continuity test of approximately .01 ohms. Many safety devices are provided for and red lights flash on to indicate reject units.

## LEAKAGE TEST

For this test an unbalanced-bridge circuit is used, switches 1 and 2 being closed. The test unit is effectively connected across the 9.5-megohm arm (A and B). The bridge is nearly balanced as it stands, so that with the addition of the unit it becomes unbalanced still further to an extent depending upon the leakage of the production unit. Greater unbalance places a greater negative potential on the 6F6 grid with a resultant smaller plate drop. The grid circuit of the 2051 thyatron (*Radio-Craft*, Sept. 1944) is adjusted so that it fires when the unit being tested is 95 megohms or less, thus indicating any leakage which might be significant in the operation of the apparatus tested.

Firing of the thyatron causes operation of the relay in its plate circuit (CR-1) closing one set of contacts in the meter circuit (lower left of the diagram) and another set in the input power circuit. The latter causes excitation of CR-2 which flashes on the red light to notify the operator. A release switch must be re-set before tests can be continued.

## CONTINUITY TEST

For this test, the unit must show .01 ohm or less, to pass. It is connected effectively across  $R_3$  (between C and D) when switch 4 is closed. A storage battery circuit with proper limiting resistors and protective circuit breaker is in series with  $R_3$ . The voltage drop across the latter is measured by a 0-1 M.A. and series resistors. Connection of a good unit across  $R_3$  lowers the voltage and gives a sufficiently low M.A. reading. Units are rejected if they give higher than a predetermined indication. If the unit is open-circuited, the high



Special cables for production checking are fitted to the checker's three receptacles.

heated, relay CR-3 maintains the meter in a shorted condition.—I.Q.

## Cyclotron Aids Health

CYCLOTRON bombardment of elements to make them radioactive renders them useful for treatment of several types of human diseases, says a recent report from the University of California.

In some instances these substances are superior to radium, since the elements may be chosen which will be sent through the body to a certain organ or group of organs, according to Dr. B. V. A. Low-Beer, assistant professor of radiology on the San Francisco campus of the University. Thus, he explained, radioactive iodine will be concentrated by the body in the thyroid gland, radioactive strontium will be collected in the bones, and radioactive phosphorus deposited everywhere in the body where there is active cellular metabolism, particularly in the bone marrow. He indicated that these chemicals may be administered by mouth or intravenously, or used locally for certain skin diseases.

the only solution would seem to be the use of projection tubes. These tubes can be produced in sufficient quantities when the war ends to bring their cost down to a level which is not overly exorbitant.

In connection with the use of projection tubes another problem arises—the placement of the image-receiving screen. Thus far, manufacturers have attempted to incorporate the screen on the console front, at the rear of the console, and have even placed it on an opposite wall. In the latter case the cabinet had to be moved away from the wall during projection, which, in the opinion of many experimenters, ruled out this possibility.

An interesting attempt to obtain the advantages of projection in a direct-viewing screen is being made by Dumont in connection with their new 20-inch tube. A set mounted in the wall with the flat face of the tube flush with its surface is out of the way and makes possible better definition than a projection-type machine throwing its images on a smooth piece of wall.

The fact that the average living room is apt to be relatively small makes it important that the television set designer find some method of reducing the size of the transmitted picture to roughly  $\frac{3}{4}$  of that provided by a home movie projector. At the present writing the inclination is strong to follow through with the "screen on cabinet front" school of thought.

Fig. 3 shows how the 20-inch tube can be used without too great a waste of floor space. The tube is retractable into its cabinet when not in use. When a program is to be viewed, the doors are opened and the tube brought out into the viewing position shown in the photograph.

The objections raised to this procedure seem to be that eye strain would result

## TELEVISION and the SERVICEMAN

(Continued from page 692)

through a constant viewing of televised programs, but there is no particular reason to believe that television set observers will keep their eyes glued on the receiver screen in anything approaching a continual process. Surveys made by concerns operating television transmitters show that listeners do not watch the screen for more than 15 minutes at a stretch. During longer programs, lasting a half hour or more, the viewer is apt to rest his or her optics with occasional glances about the room. More to the point, a considerable portion of televised entertainment consists of vocalizing and instrumentalizing and it is not necessary that the vocalist or instrumentalist be closely observed at all times.

Of more than passing interest to the servicing fraternity, is the question of controls to be located on the front panel of the television receiver. Opinion, at

the moment, seems to favor the placement of a focus control, mounting field and line control directly underneath the screen easily accessible to the operative. At least one television set manufacturer has worked out a push-button arrangement for all knobs on the front panel.

According to television set designers, the postwar television receiver will contain upwards of 25 to 30 tubes. This number will quite definitely stay put, for engineers are in wholehearted agreement as to the futility of attempting to streamline the tube com-  
(Continued on following page)

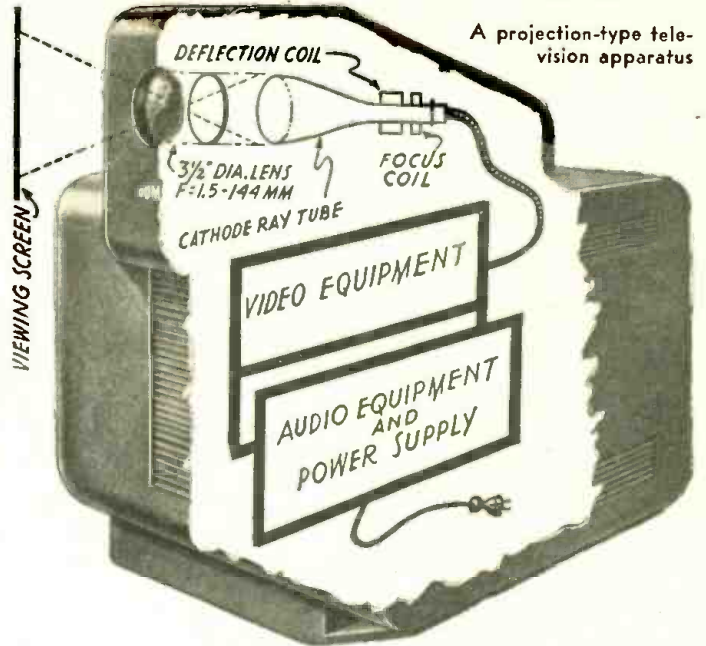

# FIX ANY RADIO

## Amazing New Invention

**Simplified  
Radio  
Servicing**

NEW  
1945 EDITION

### REPAIR ANY RADIO IN MINUTES

Learn time-saving trouble-shooting short-cuts; find any radio fault with ease. Follow the tests shown on 24 large circuit blueprints. Over 1,000 practical repair hints. Hundreds of simplified tests using a 5c resistor and any filter condenser. Introductory material for beginners and to serve as review for experienced radio men. Several chapters on test equipment. Complete plan in manual form, 64 job-sheets, data on all tubes, size: 8 1/2 x 11 inches. Sold on no-risk trial. Money-back guarantee. Use coupon to order →

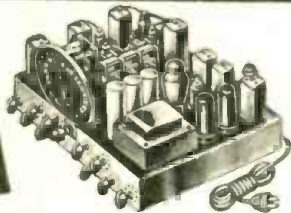

This newly developed method tells you how to locate the source of trouble in any radio set without equipment. Make needed tests, measure voltage, trace the signal, by using only a 5c resistor, small condenser, and a crystal detector. Inject signals without any signal generator. Test parts by the new Comparison method. Test tubes without equipment. Repair any radio expertly following illustrated, simplified plans. Quickly improve your radio servicing ability. Data on all sets, portables, AC-DC, FM, recorders, intercoms, P.A. Examine and apply the plan for 10 days without obligation. Send coupon today →

Find radio faults with a new simplified method. Repair all radios in minutes instead of hours. New, revolutionary different Comparison technique permits you to do expert work almost immediately. Most repairs can be made without test equipment. Simple point-to-point, cross-reference, circuit suggestions locate faults quickly and easily. You may try this unique plan without risk or obligation.



Developed by  
M. N. Beitman,  
radio engineer,  
teacher, author,  
& serviceman.

COMPLETE PLAN  
**\$1.50**

### TRIAL ORDER COUPON

**Supreme Publications**

PUBLISHERS OF RADIO BOOKS, MANUALS, AND DIAGRAMS

9 S. Kedzie Ave.

Chicago 12, Illinois

Ship postpaid the new complete Simplified Radio Servicing manual for 10 days' examination. I am enclosing \$1.50, full price. I must be entirely satisfied or you will refund my total remittance.

NAME: .....

ADDRESS: .....



# RADIO-CRAFT'S LIBRARY

## presents 4 BEST SELLERS

HERE are four of the handiest, most informative books that this popular technical library ever turned out. They hardly need an introduction. Their usefulness is already an established fact, proven on the best "proving ground" in the world: "The field of practical application."

Yes, indeed, thousands upon thousands of technicians, servicemen, experimenters, trainees use these books daily. They are just the right size to slip in the pocket so you can read them when travelling. The knowledge gained from these self-help books can be used in countless ways; for example, in building a home-set; when servicing an outside job; or when preparing for an examination. Many men in the armed service who are aiming toward a higher rating are making excellent use of these books. The price, only 50¢ each, and less when you buy more than one at a time, is trifling when you consider that the first application of the knowledge gained will likely pay the cost of all four books.

### No. 25—Home-Made Radio Test Instruments

Outline of Contents: A Low-Cost Signal Chaser—Signal Tracer Test Unit—Simplified Practical Signal Tracer—A Home-Made Impedance Tube Checker—Build This Direct-Reading V.T. Voltmeter—How to Make a Modern V.T. Voltmeter—Measuring High Values of A.C. Voltage and Current with a Low-Range Meter—How to Make a Meter-Range Extender—How to Build a Practical Tube Tester and Set-Analyzer Adapter—The Beginner's Simple Volt-Milliammeter—Build This Simplified Neon-Type Test Unit—Midtest Oscilloscope—How to Make and Use a Frequency Wobbler—Double Tracing Your Oscilloscope—Home-Made Frequency Modulator.

### No. 26—Modern Battery Radio Sets

Outline of Contents: Beginner's 1-Tube High-Gain All-Wave Receiver—Beginners-Build This 1-Tube Loop Receiver—A "3-in-1" Battery Portable—An Easily-Built "Fleewheel Superregenerative" 2-in-1 "Card File" Battery Set—A 2-Tube Superhet. With Pentagrid Regenerative 2nd-Detector—The 4-Tube Superhet. Vacuum Portable—"Lunchbox 3" Battery Portable—"The Seafarer" Loop-Type Boat Radio Set—4-Tube Permeability Portable—An All-Purpose Portable—A Typical Commercial 3-Way Portable (Pilot Models X-1452 and X-1453)—Switch for Varying "C" Bias on Battery Radio Sets—Making a Simple Portable Aerial—Making a Pilot-Light Fuse—Old Auto Sets for New Cars—Using a Loop Portable in Cars—Quasi-Electric Soldering Iron—Lamp Bulbs as Resistors.

### No. 27—Modern Radio Servicing Technique

Outline of Contents: Elementary Servicing Technique—Correct Procedure for the Servicing Beginner—Elementary Procedure for Servicing Radio Sets—A.C. Air Circuit Made Easy—Dynamic Servicing—Dynamic Testing Simplifies Servicing—Modern Receiver Test Requirements—Servicing Universal A.C.D.C. Receivers—Servicing "Orphans" and Private-Brand Sets—Emergency Servicing Without Test Meters—Servicing Coils—Servicing R.F. Coils—Servicing Oscillator Coils—General Information—RMA Transformer Color Code—What Causes Echo, Fading?—Radio Service Puzzlers.

### No. 28—All About Frequency Modulation

Outline of Contents: The ABC of F.M.—Frequency vs. Amplitude Modulation—Basic Facts About F.M. Broadcasting—Construction—Build This Practical F.M. Adapter—Audio Amplification—F.M. Audio Amplifier, Part 1—F.M. Audio Amplifier, Part 2—F.M. Audio Amplifier, Part 3—F.M. Service—Part 1, Antenna Installation and Service—Part 2, Receiver Alignment and Diagnosis—Part 3, Test Equipment for F.M. Servicing, Engineering—Part 1, The How and Why of F.M.—Part 2, The How and Why of F.M.—Theory and Design Considerations of R.F. and I.F. Coils in F.M. Receivers.

Almost all television receiver servicing will be handled in the home because of the need for antennae adjustment, and because with such a multitude of tubes, testing them will be the first step in servicing procedure after the antennae has been checked. This is regular radio servicing procedure, and outside the special synchronizing and "framing" pulse circuits, most of the rest of the equipment is along standard radio lines.

Summing it up, the radioman who takes the time and trouble to bone up on television theory and practice within the next few months will be many steps ahead of the individual who believes in the theory of procrastination.

## WORLD-WIDE STATION LIST

(Continued from page 712)

21.470	GSA	ican beam. 8:45 to 10:15 am; 11:45 am to 3:30 pm.
21.530	GSJ	LONDON, ENGLAND: Africa. 7:45 to 11 am.
21.550	GST	LONDON, ENGLAND.
21.640	GRZ	LONDON, ENGLAND.
21.675	GYR	LONDON, ENGLAND: India. 5 to 7:30 pm.
21.710	GVS	LONDON, ENGLAND.
21.750	GVT	LONDON, ENGLAND.
25.750	GSQ	LONDON, ENGLAND.
26.100	GSK	LONDON, ENGLAND.
26.400	GSR	LONDON, ENGLAND.
26.550	GSS	LONDON, ENGLAND.

## NEW RADIO SLIDE RULE

A NEW radio slide rule especially designed to provide a fast and accurate means of solving problems involving resistors in parallel and capacitors in series has just been put out by Allied Radio Corporation of Chicago.

A single setting of the slide automatically aligns all pairs of resistors which may be connected in parallel, or capacitors which may be connected in series, to provide any required resistor or capacitor value. Range: 1 ohm to 10 megohms; 10 mfd. to 10 mfd.

The new rule, which is priced at 25c, is made of heavy glazed card, with a slider of the same material, resembling somewhat the earlier Allied Coil Calculator described in this magazine last year.



## DIAL CABLES

By Ed CARTER\*

Of all the jobs one has to do  
When fixing sets—I think it true  
The one which tries each mother's son,  
Is putting dial cables on!  
For dial cables weave about  
Around the pulleys; in and out;  
They run first there, then back to here;  
Go up and down—run far and near!

Two hands, I've found, are not enough  
To do this job—it's mighty tough;  
Your hands are insufficient for  
This type of work—one should have four!

And if by luck the way is found  
To rightly string the cable 'round,  
The darn thing comes out short—Ah woe!  
At this point you feel mighty low!

Let's moan a dirge of deep despair;  
Let's shed a tear; let's roundly swear;  
Let's curse the day of infamy  
That dial cables came to be!

\*Radio K.U.J., Walla Walla, Washington.

## MAIL THIS COUPON TODAY →

All four books are listed uniformly at 50¢ each. No discount on less than three books. If you wish to take advantage of our special offer, ordering three books or more, we make an unusual low price to you as follows:  
3 books—\$1.25 4 books—\$1.50

Do not fail to send coupon today!  
**RADCRAFT PUBLICATIONS, INC.**  
25 West Broadway, New York 7, N. Y.

**RADCRAFT PUBLICATIONS, INC.** 8-45  
25 West Broadway, New York 7, N. Y.  
Gentlemen:  
Rush to me by return mail, as per your special offer, the following books: (Check books selected.)

No. 25—HOME-MADE RADIO TEST INSTRUMENTS.  
 No. 26—MODERN BATTERY RADIO SETS.  
 No. 27—MODERN RADIO SERVICING TECHNIQUE.  
 No. 28—ALL ABOUT FREQUENCY MODULATION.

WE CANNOT SEND C.O.D.

NAME .....  
ADDRESS .....  
CITY ..... STATE .....  
Remit by Cash, U.S. new postage stamps, money order, check. Foreign countries add 20% to all prices quoted.

(Continued from previous page)  
plement. The majority of tubes used will be of the midjet variety, to conserve space so badly needed. These tubes, with the exception of the projection tube division, will present no particular problem to the serviceman in general, but it should be emphatically stated that an extremely high voltage will be delivered to the cathode-ray tube from the power supply. Unless the greatest care is observed in handling this section of the television receiver the radioman may very easily become the mortician's delight. High voltage is never pleasing at best and 30 or 40 kilovolts can be very disconcerting to the human chassis.

Which brings us to the all important topic of television servicing tools. Present tube-testers are all well and good, so far as the sound end of the television receiver is con-

cerned. Test equipment providers are apparently hatching a new line of adapters which, when used in conjunction with present testing equipment, will enable the radioman to cope with visual receiving equipment.

Moreover, many tube-testers and set analyzers, now reposing in service centers, are on their last legs and will need to be replaced. The serviceman may as well earmark several hundred dollars for postwar television testing equipment. It will be important that the radioman handling television servicing activities be in the possession of a cathode-ray-oscilloscope which will add a further investment of \$65.00 to \$100.00, depending on the make and model.

It will be impossible to guarantee service work for the first few months of television activity and flat-rate servicing will be tossed out of the window in no uncertain terms.

## BATTERY RACKET

**W**ARNINGS of a widespread racket in selling spurious compounds to motorists under the guise of battery accelerants were issued recently by the American Association of Battery Manufacturers, the Automobile Club of New York, and the Society of Automotive Engineers. Not only are these mixtures worthless, but at least 90% of them are harmful to the extent that they will eventually ruin the unit to which they are applied, according to the findings of the three organizations.

These racketeers are preying on the car owner and storage battery dealer, selling them flour, sand, Epsom salts or just any old white powder as the panacea for all battery troubles.

Stated in a few words the greatest trouble with the storage battery is "sulphation." This term means "excess sulphation," in other words a crystalline sulphate which usually forms on the surface of the positive plates of a storage battery. When the sulphate covers the peroxide of lead (which is the active material of the positive plate), the battery cannot be charged properly for the reason that the sulphate is a part insulator and also prevents the acid from properly circulating through the lead peroxide of the plate. This, therefore, cuts down capacity, i.e., the output of the battery, to a large extent and it becomes useless.

So far there has not been invented a chemical that can be put into the battery electrolyte that will successfully dissolve the sulphate without harming or destroying it.

Sulphation can be remedied by charging the storage battery at a very low rate. The low rate is necessary, because the battery will overheat if given a normal charge, the sulphate being an insulator. The sulphate can be broken down in this manner but only partly. If the plates have not been sulphated too much there is only one remedy left. That is to tear down the entire battery, take out the separators, put in new ones and if possible scrub the face of the plates when they have dried with a steel brush, which removes some of the sulphate. This is a costly procedure but is the only sure remedy.

One of the most popular forms of this swindle is to offer a powder which is supposed to possess some magic qualities of battery rejuvenation when mixed with fluid. Under a good presentation, the product, which might cost ten cents, can be sold for twenty times that amount. The result is a series of woes for the motorist. As yet, no legitimate pepping-up compounds have been discovered which may be added to the solution in the battery cells. No satisfactory substitute has been found, regardless of the claims to the contrary, for storage battery electrolyte, which is a mixture of sulphuric acid and water. Both the United States Bureau of Standards and the American Automobile Association have condemned the use of adulterants or "dope" chemicals to enliven a weak battery. Most battery manufacturers void guarantees on their products if other than sulphuric acid and distilled water is added.

The only way to enliven or keep a battery usable for as long as possible is to take the proper care of it. The battery should be checked and water added regularly. Have the acid level tested and add distilled water to three-eighths of an inch above the separators or plates. Make certain that the terminals are clean, tight and free from corrosion to permit the free flow of current and full use of the battery's power. Keep in mind that: "However alluring the advertising may be, or how conclusive the glowing testimonials, scientific tests have shown them worthless."

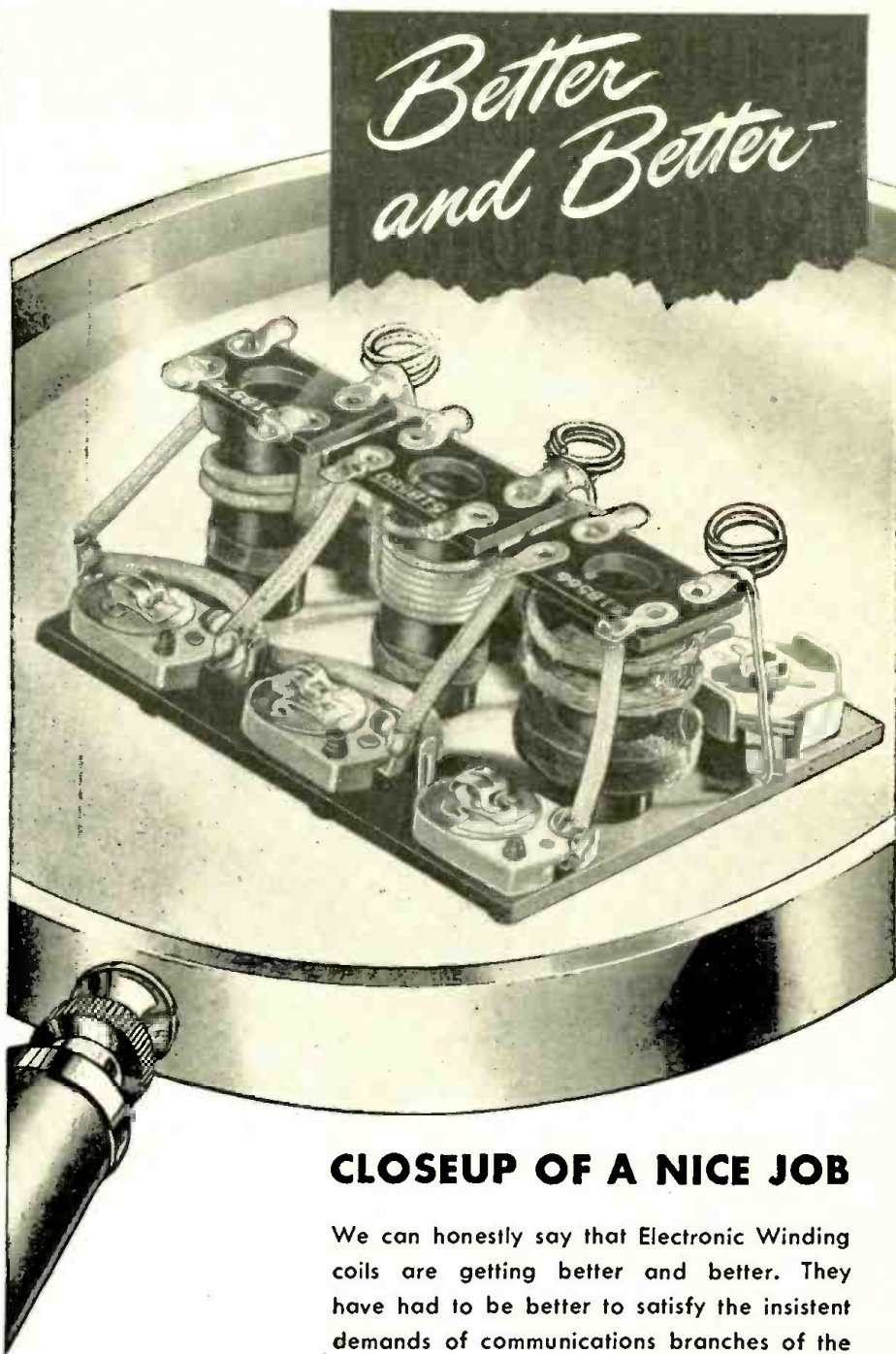

## CLOSEUP OF A NICE JOB

We can honestly say that Electronic Winding coils are getting better and better. They have had to be better to satisfy the insistent demands of communications branches of the armed services and to contribute to the dependability of rugged radio equipment that is helping to save lives all around the world. This closeup of a nice job of coil winding shows a complete RF assembly — just one of the many precise jobs we can do. If specifications call for a coil of extra quality call on Electronic Winding.

# Electronic Winding Co.

5031 BROADWAY  
CHICAGO 40, ILL.

★ ★ MANUFACTURERS OF EXTRA  
QUALITY COILS FOR PRECISION  
COMMUNICATIONS EQUIPMENT

# LET THIS "AUTOMATIC TEACHER" show you exactly how to repair over 4800 RADIO MODELS without expensive test equipment!

## SAVE TIME-SAVE MONEY!

Girardi's RADIO TROUBLESHOOTER'S HANDBOOK is the ideal manual to show you exactly how to repair radios at home in spare time—quickly and without a lot of previous experience or costly test equipment. It contains MORE THAN 4 POUNDS OF FACTUAL, time-saving, money-making repair data for repairing all models and makes of radios better, faster and more profitably than you may have thought possible!

### NOT A "STUDY" BOOK

RADIO TROUBLESHOOTER'S HANDBOOK can easily pay for itself the first time you use it. You don't have to study it. Simply look up the make, model, and trouble symptom of the Radio you want to repair and go to work. No lost time! Clear instructions tell exactly what the trouble is likely to be—EXACTLY how to fix it. Actually, this big 744-page manual-size HANDBOOK brings you factual, specific repair data for the common troubles that occur in practically every radio in use today—for over 4800 most popular models of Home and Auto-radio receivers and Automatic Record Changers of 202 manufacturers! In addition, there are hundreds of pages of helpful repair charts, tube charts, data on tuning alignment, transformer troubles, tube and parts substitution, etc., etc.—all for only \$5 (\$5.50 foreign) on an UNRESERVED 5-DAY MONEY-BACK GUARANTEE!

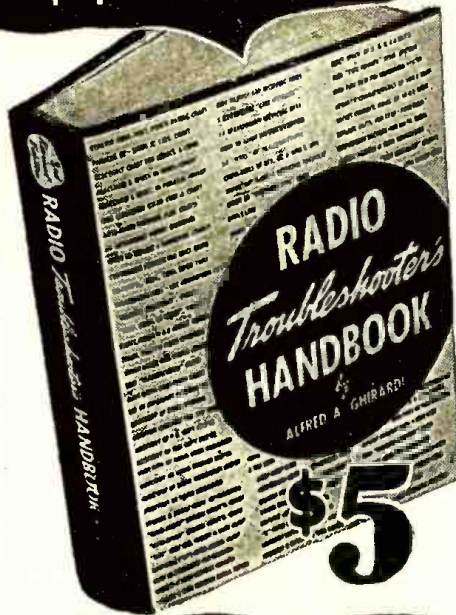

## Get a Complete RADIO-ELECTRONIC SERVICE EDUCATION AT HOME—WITHOUT AN INSTRUCTOR

### TEST INSTRUMENTS—TROUBLESHOOTING REPAIR

A. A. Ghirardi's big 1300-page MODERN RADIO SERVICING is the finest, most complete instruction book on Radio-Electronic service work for either the novice or the professional Radio-Electronic serviceman—*bar none!* Read from the beginning, it is a COMPLETE COURSE IN SERVICING by the most modern methods. Used for reference, it is an invaluable means of brushing up on any servicing problems that puzzle you.

Gives complete information on all essential service instrument types; how they work (with wiring diagrams), when and why to use them; how to build your own; preliminary trouble checks; circuit and parts analysis; parts repair, replacement, substitution; obscure radio troubles; aligning and neutralizing; interference reduction—and hundreds of other subjects including How to Start and Operate a Successful Radio-Electronic Service Business. 706 self-testing review questions help you check your progress EVERY STEP OF THE WAY. Only \$5 complete (\$5.50 foreign).

### MONEY-SAVING OFFER!

While the present limited supply lasts you can get BOTH big books—radio's most famous complete Modern Service Library totaling over 2030 pages—at a bargain combination price. See coupon.

### 5-DAY MONEY-BACK GUARANTEE

Technical Division, MURRAY HILL BOOKS, Inc.  
Dept. RC-85, 232 Madison Ave., New York 16, N. Y.

Enclosed find \$..... for books checked, or  send C.O.D. (in U.S.A. only) for this amount plus postage. If not fully satisfactory, I may return the books at the end of 5 days and receive my money back.

MODERN RADIO SERVICING  RADIO TROUBLESHOOTER'S HANDBOOK \$5 (\$5.50 foreign)

Special MONEY-SAVING COMBINATION  
Both big books for only \$9.50  
(\$10.50 foreign)

Name ..... (Please print or write plainly)

Address .....

City and Dist. No. .... State .....

**"BORROW" THESE BOOKS** for 5 full days. Money refunded if you don't like them!

## RADIO ELECTRONICS

(Continued from page 690)

follows: facsimile, 106-108; non-Government fixed and mobile services, 42-44 and 72-76 megacycles. This closes the allocation of frequencies between 25 to 30,000 megacycles.

The FCC believes the present decision, moving FM "upstairs" from the band between 42 and 50 megacycles, will make it freer from interference and other shortcomings than it would be in any other portion of the spectrum.

Recognizing that considerable opposition was advanced by manufacturers and engineers skeptical as to the advantages of the higher-frequency band, the Commission stated that it "has a duty to consider the long-range effects of its action as well as the effects during the months immediately ahead, and it doesn't propose to provide an inferior FM service during the decades to come merely because of the transitory advantages which may be urged for an inferior type of service."

## THE RADIO ALARM

(Continued from page 689)

which may work even better than the coherer.

One thing is certain, the radio alarm is a device which is badly needed. Our radio technicians and experimenters will find this a fascinating and promising field in which to do further research and developing work.

If readers have any worthwhile thoughts on the above, *Radio-Craft* will be happy to receive suggestions and ideas on the subject.

## RADIO ELECTRONICS

(Continued from page 691)

loss of circuit time. Each incoming letter is comprised of three marking (signal) impulses, plus four spacing (no signal) impulses. The name—seven unit—stems from this fact. Automatic counting features incorporated in the receiving printer check the arriving impulses, and if the marking impulses vary from three, the warning bell sounds and the maltese cross emerges to report an error.

Vital to the system is a newly perfected method for keeping the receiving channeling devices in exact step with the distant transmitter and the signal elements being sent through the air.

Improvement in time division multiplex operation has been achieved through the inclusion in the same mechanism of the devices that perform the basic channeling function and also of the face plates which pass the signal elements from or to the seven-unit printing equipment in the proper sequence and at the right time intervals for transmission and reception.

In physical appearance, transmitting and receiving equipment used in the new RCA system is at but slight variance from conventional radiotelegraph apparatus, in spite of its amazing performance. At each terminal of the circuit are two cabinet racks 84 inches in height, each containing a multiplex distributor, visible about halfway between top and bottom. One rack is primarily for receiving and the other primarily for transmission. Other equipment includes printers, keyboard perforators and tape transmitters.

The amazing performance of the new circuit leads the engineers to predict wide use for eight-channel equipment in handling postwar traffic.

## Combination Lip Mike

A "SUBMERSION-PROOF" combination lip mike and headset has recently been developed by the scientists of the Bell Telephone Laboratories. This is particularly valuable since armed amphibious tractors used in storming beachheads usually completely submerge before their high speed pumps can clear out the water, giving both the men and equipment a thorough soaking.

The average mike or headset cannot take this sort of treatment for long, but the new combination is completely immune to all of this. Equipped with a specially designed gland or valve which will pass air but exclude water, the new microphone is capable of withstanding a submersion cycle of 25 minutes under ten inches of sea water followed by baking in an oven at 125 degrees Fahrenheit, repeated five consecutive times without damage to the instrument. This gland also permits equalization of air pressure under altitude changes, which allows for safe transport of this equipment to the fighting front via cargo plane.

Not much larger than a half-dollar and less than one-half inch thick, the microphone employs the differential principle of operation. The average articulation is about 86% on a multi-syllable test with both talker and listener in a noise field composed of simulated airplane noise at a level of 118 db. Thus, the mike and headset assembly can deliver and receive articulate speech under most adverse noise conditions of modern battle.

The headset is of the flat-response type and is so designed that it may be worn under the Armored Force Crash Helmet or standard steel type helmet. Fitted with soft neoprene ear-cushions, the set assures high transmission quality.

The whole assembly, including the harness for holding the lip mike firmly but comfortably in position weighs less than 20 ounces, and will function satisfactorily under temperatures varying from minus 40 to plus 175 degrees Fahrenheit. The microphone is a single button type capable of operating into the carbon mike circuits of military equipment. The average button current is approximately 50 milliamperes.



The combination set displayed to advantage.

RADIO-CRAFT for AUGUST, 1945

# ALL THE SCIENCE OF BASIC RADIO-ELECTRONICS

in one big  
3½ lb. book

WRITTEN FOR BEGINNERS

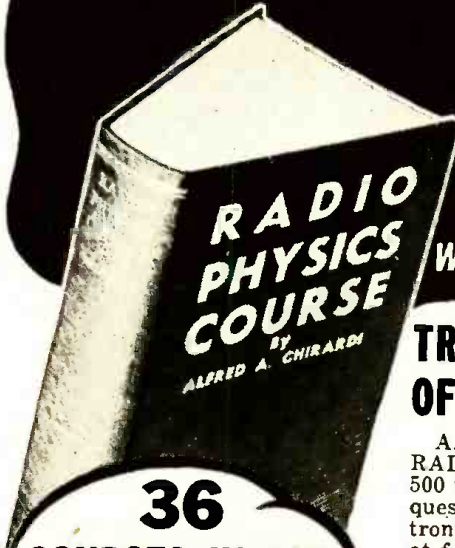

36  
COURSES IN ONE

If this big book were broken into monthly lessons and sold as a "Course" you'd regard it as a bargain at \$80 or more! In this convenient book form you get it for only

\$5 COMPLETE

This is only a fraction of what RADIO PHYSICS COURSE brings you: First, over 300 pages devoted to a vitally important foundation in Basic Electricity... all made simple as A-B-C by clear explanations and over 150 illustrations; also broadcasting; Sound, Speech, Music; Radio transmission; Broadcasting stations; Receiving units; Vacuum tube theory, characteristics, construction, action; Detection; R-F amplification; Audio amplification; Super-heterodyne receivers; Tuning coils; Loudspeakers! Microphones; Power Supply units; Auto Radios; Aircraft Radio; Phonograph pickups and amplifiers; Public address systems; short wave characteristics and equipment; Photoelectric cells; Television; Sound movies;—and many other subjects and chapters!

## "THE ELECTROLYTIC CAPACITOR"

An Important New Book on a Little-Known Subject

Probably no Radio-Electronic component is more vitally important than the Electrolytic Capacitor—and this new book by Alexander M. Georgiev, who has devoted more than 15 years to electrolytic capacitor research and development, answers all the many questions engineers, servicemen and others have been asking about the various types of electrolytic capacitors... their construction, characteristics, advantages, applications, measurement, testing, defects, etc., etc. Tells when and where to use electrolytics in preference to non-electrolytic types; relative merits of "wets" versus "drys"; applications at low and high voltages and frequencies; a-c or pulsating d-c, ambient conditions, etc., etc. The most important book ever written on this vital subject! Only \$3 complete.

JUST OUT

Complete modern data on Electrolytic Capacitors in one authentic volume.



## RADIO'S GREATEST TRAINING BUY!

Technical Division, MURRAY HILL BOOKS, INC.  
Dept. RC-85, 232 Madison Ave., New York 16, N. Y.

Enclosed find \$5 (\$5.50 foreign) for Ghirardi's RADIO PHYSICS COURSE book; or  send C.O.D. (in U.S.A. only) for this amount plus postage. If not fully satisfactory I may return it at the end of 5 days and have my money refunded.

Check here for Georgiev's "THE ELECTROLYTIC CAPACITOR" book, \$3 (\$3.25 foreign).

Name .....

Address .....

City and Dist. No. .... State.....

# 5-DAY MONEY-BACK GUARANTEE

# 10,000 PARTS

Ten thousand different  
radio and electronic parts immediately  
available on priorities

# SERVICE

Trained expeditors select  
and ship same day your order  
is received

# EXPERIENCE

Known since 1922 as reliable  
jobbers, wholesalers and manufacturers of  
radio and electronic equipment

# Radio Wire Television Inc.

100 Sixth Ave. (Dept. A-8) New York 13, N. Y.  
Boston, Mass. Newark, N. J.  
World's largest Radio Supply House

Originators and  
Peacetime Marketers  
of the celebrated

# Lafayette Radio

Write today for our bargain  
flyers and special bulletins.

## TUBE REPLACEMENTS

(Continued from page 701)

The case of Fig. 3a represents an inefficient one, the extra current merely heating the shunts. Therefore, the original circuits should be restored as soon as a 12SQ7-GT/G becomes available. In the latter case, it would simply be a matter of removing the two shunts, and the line resistor need not be again replaced. The heat dissipation of such a shunt is low (1 watt for every 6 volts which must be dropped).

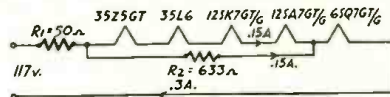

Fig. 3a

The above principles apply to the D.C. type of filaments when operated in series from batteries or a power line rectifier. In the first case, it may be possible to add or subtract cells from the battery to correct for changes in the total filament voltage required. In the second case, check whether the rectifier is able to supply additional current if needed. Also, remember that the rectifier tube itself should not be shunted. Up to the normal current drain, the rectifier output voltage may be assumed fairly constant.

### PARALLEL FILAMENTS

In these circuits all filaments are rated at the same voltage, usually 6 volts, and do not require the same current. Because each filament is independent of the others, and many 6-volt types are available, parallel filament circuits usually permit more opportunity for finding tube substitutes.

Tubes which require the same voltage are listed in Table II under "parallel" and may therefore be directly substituted without change in such receivers. It is assumed that the transformer or other voltage supply will handle the extra current when this is required.

Tubes requiring less filament voltage may be used by including the proper voltage-dropping resistor as in Fig. 4, where a 2A7

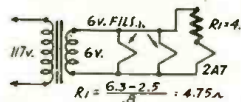

is used to replace a 6A7. If the transformer is provided with extra taps, it may be possible to obtain 2.5 volts directly from it. If the 6.3 winding is center-tapped, the 2A7 may be operated from one-half of the wind-

ing (3.15 volts) through an .8-ohm, 1-watt resistor.

$$R = \frac{E}{I} = \frac{3.15-2.5}{.8}$$

Unless the set is an ultra-midget, don't overlook the possibility of adding a midget 6.3 filament transformer to aid tube substitution. Such transformers, providing one or two amperes, are available in very small size and weight. If connection is made as in Fig. 5, a 12-volt tube may be operated alongside 6-volt tubes.

### REPLACING RECTIFIERS

Rectifiers and power amplifiers of the A.C.-D.C. type seem particularly difficult to replace these days. In common with most other tubes, they reach the end of their useful life more often by showing weak emission than by burn-out.

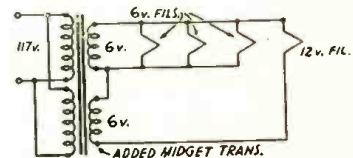
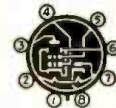

Fig. 5

Should a set come in having both rectifier and power amplifier weak but not burned out, a good replacement can be made by the use of one of the 117-volt types which combines a rectifier and amplifier in one envelope. For example, the 117N7GT, if available, can be hooked up either inside the radio or in a separate box. Requiring no voltage-dropping resistor, the wiring is simple and the efficiency high. It is only required to disconnect all terminals of the original two tubes (except filaments) and reconnect them to the respective pins of the new tube, (Fig. 6).



Where the rectifier alone is weak and a dynamic speaker is used, the set wiring should be checked. In such cases one diode often supplies the speaker and the other diode the plates. Set operation and efficiency may be improved, and the need for tube replacement eliminated by connecting both diodes in parallel and substituting a P.M. speaker for the original.

## ELECTRONIC METRONOME

(Continued from page 699)

rhythm while you proceed with your musical practice. One precaution: Be sure that you are not radiating such a strong signal that you are creating interference. The F.C.C. has established a definite ruling on that matter. *There must be absolutely no interference with other radio reception.* This is absolute. Should a neighbor in an adjoining apartment—say 30 feet away—hear your metronome or code oscillator while listening to a local station, your machine is clearly illegal.

(Should the same neighbor, by tuning between two stations and turning up his volume control, be able to hear the transmitted signals, this would probably not render the transmissions illegal as such recep-

tion could hardly be considered interference.) A simple formula for determining if your "transmitter" is illegal or not is:

$$157,000 \text{ — ft.}$$

frequency (Kc.)

For example: if a device is operating at 550 Kc., the permissible range is 157,000/-550 or approximately 285 feet:

### Frequency Unmodulated

The female's often found to be  
A glib broadcasting station  
That prattles with high frequency  
And little modulation!

—Addison H. Hallock



## RADIO ROBOT PLANE

(Continued from page 694)

could precede or surround the bombers they protect, sometimes emitting smoke screens to confuse the enemy aircraft.

Since they could not be retrieved, and their object would always be to destroy themselves with their deadly cargo, it is apparent that they could be constructed of nondurable materials. Being small and light, they could be produced in huge quantities at comparatively low cost. They would represent an enormous "suicide squad," but one which would not risk a single life of the operating forces. While they could be adapted equally well to protect shipping when operated from surface vessels, their greatest all-round use would be as bomber-based flying bombs.

This particular radio-controlled bomb would have several unique features differentiating it sharply from long-range robot planes controlled by set mechanisms, such as the V-1 type used by the nazis against England. The latter must have sufficient instruments to detect, correct and compensate for variations in air density, winds and course changes caused by exploding anti-aircraft shells. Being controlled within the limits of visual range from mother aircraft (these limits may extend up to a hundred miles under good weather conditions if observed through high-powered glasses and if equipped with smoke trail apparatus), the flying bomb is not a robot in the sense of those that are launched with pre-set controls. If anything, it becomes more of a precision bomb than those which are dropped in free flight and over which no further control can be exercised.

The constructional possibilities are disclosed in the accompanying illustration. Essentially, this radio-controlled bomb could be made in three sections which could be nested into each other for final assembly. The forward section or nose would contain the small compression-ignition engine, together with fuel tanks and propeller. Due to their short-range action, fuel tanks would be relatively small. The center section would be the actual bomb containing the explosive, which could be detonated either through the firing pin extending through the forward power section, past the propeller spinner, or by means of radio through a detonator operated from the rear section. The rear section would carry the radio receiver connected directly to the tail surface controls. Connecting rods, cables and wires therefore would be direct and short. The wings would set into special recesses and hooks on the center section.

While controllable bombs of this type would cost more than free drop bombs of similar weight, they might in all likelihood reduce heavy bomber losses because the latter could remain well away from the target area in any direction.

Excerpt from "Aircraft Armament," published by Aerosphere Inc., N. Y. C.

## CORRECTION

A couple of lines were omitted in the article "New Automatic Radio Compass," column 3 of page 696. The following lines should be inserted in the first paragraph; . . . "(b) aural reception of modulated or unmodulated radio-frequency energy using a non-directional antenna;"

These lines should be inserted in the paragraph at the twelfth line, directly after section (a) in the description of the radio-compass, which starts: "automatic bearing indication of the direction of arrival of radio frequency energy," etc.

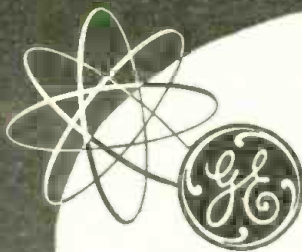

## UNIMETER

This unit fulfills an extremely important need for general utility portable service equipment. It has wide range coverage for both a-c and d-c measurements of voltage, current measurements on d-c and the popular ranges on resistance.

The UM-3 is designed to clearly indicate all the functions which aid in the prevention of application of high voltages when preparing for current or resistance measurements.

Other G-E units for better servicing include: Tube Checker TC-3, Unimeter UM-4, and Oscilloscope CRO-3A.

Write: *Electronics Department, Specialty Division, General Electric, Syracuse, New York.*

*Electronic Measuring Instruments*

**UM-3 GENERAL ELECTRIC**

177-D2

## Announcing THE NEW SUPREME MODEL 565 VACUUM TUBE VOLTMETER!

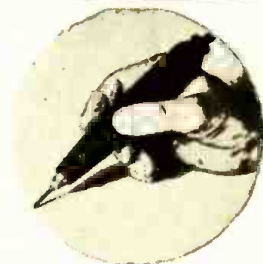

New type hand-fitting probe allows ease of measurements, handles just as any ordinary test lead. Probe incorporates new high-frequency diode giving best possible frequency response. Completely new, balanced, highly degenerative bridge circuit allows higher input impedances (best de-tuning on RF circuits) and greater stability than ever before.

### RANGES:

DC 0-1, 2.5, 10, 50, 250, 500  
AC 0-1, 2.5, 10, 50, 250

EXTENDED TO 5000 VOLTS BY EXTERNAL MULTIPLIERS

### INPUT RESISTANCE:

DC—80 megohms on 1 volt range; 40 megohms on 500 volt range  
AC—40 megohms on 1 volt range; 20 megohms on 250 volt range

INPUT CAPACITY OF PROBE: 5 micro-micro farads

### FREQUENCY RANGE:

Negligible frequency error from 50 cycles to 100 megacycles.

**SUPREME INSTRUMENTS CORPORATION GREENWOOD MISSISSIPPI**

# FREE

## THIS VALUABLE ELECTRICAL BOOK

Big set of Shop Prints

and Wiring Diagrams—Yours to Keep!  
FOR LOOKING OVER NEW 7-Vol. Set

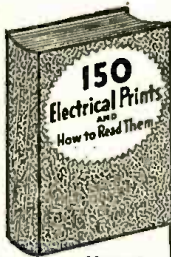

## APPLIED PRACTICAL ELECTRICITY

This 7-Vol. set, just off the press, covers everything electrical—wiring, lighting, A.C., D.C., motors, automotive, radio, refrigeration, air conditioning, RADIO, ELECTRONICS. Big section on home appliance repairs. Easy, practical, fully illustrated. Beginner or old-timer, you need this great set!

**SEND NO MONEY!** Coupon brings complete set for 7 DAY FREE TRIAL. Examine it, use on job. FREE 150 Shop Prints Book is YOURS TO KEEP REGARDLESS OF WHETHER OR NOT YOU DECIDE TO KEEP THE 7-VOL. SET. Get out of the "one-operation" type of job—handle all kinds. Send for Set and FREE 150 Shop Prints Book NOW. Coupon is not an order, just a request to see the books!

COYNE ELECT. SCHOOL, Dept. C5-71-500 S. Paulina, Chicago 12, Illinois  
Send postpaid 7-Vol. Applied Practical Electricity, RADIO, ELECTRONICS, and FREE Book of 150 Shop Prints. In 7 days I'll return 7 vol. and owe nothing, or send \$3.00 and \$3.00 monthly until \$21 is paid. Irish price \$19.75—you save \$1.25! The 150 Shop Prints Book is mine to keep FREE! regardless whether or not I keep the 7-Vol. Set.

NAME \_\_\_\_\_ AGE \_\_\_\_\_  
ADDRESS \_\_\_\_\_  
FIRM EMPLOYED BY \_\_\_\_\_

## OPPORTUNITY AD-LETS

Advertisements in this section cost 20 cents a word for each insertion. Name, address and initials must be included at the above rate. Cash should accompany all classified advertisements unless placed by an accredited advertising agency. No advertisement for less than ten words accepted. Ten percent discount six issues, twenty percent for twelve issues. Objectionable or misleading advertisements not accepted. Advertisements for September, 1945, issue must reach us not later than July 23, 1945.  
Radio-Craft • 25 W. B'way • New York 7, N. Y.

MAOAZINES (BACK DATED)—FOREIGN, DOMESTIC. etc. Books, booklets, subscriptions, pin-ups, etc. Catalog 10¢ (refundable). Clecron's, 863 First Ave., New York 17, N. Y.

BUILD RADIO COMPLETE WITH TUBES \$10.95. details. Radio, 9418b Avenue "A", Brooklyn, N. Y.

EMBOSSD AND PLAIN BUSINESS CARDS. SPADA, 10 Lexington, Wethersfield 9, Conn.

USED CORRESPONDENCE COURSES AND TECHNICAL Books Bought, Sold, Rented. Catalog Free. Educational Exchange, Menager, Alabama.

CORRESPONDENCE COURSES AND SELF-INSTRUCTION books, slightly used. Sold, Rented, Exchanged. All subjects. Satisfaction guaranteed. Cash paid for used courses. Complete information and 92-page illustrated bargain catalog Free. Write—NELSON COMPANY, Dept. 2-39, Chicago 4.

In the Rocky Mountain Region  
it's

**RADIO & TELEVISION SUPPLY CO.**  
806 EUCLID AVE., PUEBLO, COLO.

"If we don't have it, we'll get it—  
or it can't be had! Phone 5729"

Tribute to radio was paid by Mrs. Franklin Roosevelt in her column, "My Day," recently, when she wrote, "Radio . . . has become a great instrument for bringing people together." She added, "Millions of people who have heard only voices on the radio have come to attach to those voices personalities and qualities of character. In many of my letters there is a sense of loss because my husband's voice will no longer come into a living room or a kitchen in some remote corner of the United States."

### CORRECTION

An error appeared in the article "Cathode Followers" by Mr. O. E. Carlson on page 562 of the June 1945 issue. Equation (1) should read "Gain equals  $G_m \cdot R_L$ ." It should read: "Gain equals  $G_m \cdot R_L$ ."

## DETECTOR CIRCUITS

(Continued from page 704)

values of load resistances. The conditions demonstrated in these charts demonstrate only the static characteristics of the tube, but are helpful in determining the dynamic conditions under which it will operate most efficiently. Due to many factors, the detector will react very differently from its static characteristics when it is fed the complex wave forms of speech or music. Even casual study indicates that the highest values of output voltage will be available with the highest values of load resistance. Such a chart is shown in Fig. 2.

The circuit in Fig. 1-a shows the second detector of a popular A.C. receiver using a 12SQ7 tube as half wave rectifier or detector, A.V.C. and first audio stage. It will be noted that in this circuit, the diode load consists of two resistances having a total resistance of .3 meg. 250,000 ohms of this resistance is employed as the volume control for the receiver. The .00025 condenser is used to filter out the pulsations which would result from the R.F. in the circuit. The direct current flowing through the load resistance is also tapped off to supply negative automatic volume control voltage for the I.F. stages of the set.

Figures 3-a-b-c show equivalent circuits at 100, 400 and 5000 cycles. At various audio frequencies, the reactance of the various condensers will change inversely as the frequency (as the frequency increases, reactance decreases). The principal offender of the high frequency shunting is the by-pass condenser, C1. Its reactance at 100 cycles is almost six and one half megohms. This value of reactance shunting 300,000 ohms will have negligible effect on the audio output at this low frequency. At 400 cycles the audio output will be still lower and at 5,000 cycles, the reactance of the R.F. by-pass condenser is 127,000 ohms. When we consider this value paralleling the load resistance of 300,000 ohms we have an equivalent resistance of only 89,227 ohms. Then, considering the A.V.C. resistor and the grid leak in parallel with the load resistance, even this value will be lowered somewhat.

### HIGH MODULATION PERCENTAGES

It has been stated that the voltage drop across the load resistance is somewhat lower than the peak charging voltage. Now, if the resistance offered to the flow of A.C. is less than that offered to the flow of D.C. will be greater than that caused by the D.C. When the shape of a modulated signal is studied, it will be noted that as the modulation percentage approaches one-hundred per cent the instantaneous current flowing through the diode becomes smaller and reduces to zero at maximum modulation. When the diode input contains signals having high modulation percentages and containing high frequencies, the R.F. by-pass condenser cannot dissipate its charge through the load resistor fast enough to follow the shape of the modulation envelope. Thus there will be frequency and amplitude distortion.

To determine the value of the R.F. by-pass condenser, the highest modulation frequency to be received will have to be considered as well as the inter-electrode capacity of the tube and the broadcast frequencies to be covered by the receiver. If its reactance is from 2 to 3 times the load resistance at the highest modulation frequency, then it will be possible to receive

signals which have been modulated up to 94 per cent without distortion. Higher modulation peaks may be received without distortion becoming noticeable. However, the reactance of this condenser should be as small as possible, because for maximum output from the detector, it is necessary for the maximum R.F. voltage to be applied to the diode plate. If the reactance of the condenser is fairly large compared to the load resistance, a large percentage of the R.F. voltage will be lost across it. It is for this reason that the diode detector is seldom employed for low frequency receivers.

### SOME CAUSES OF DISTORTION

The shunting effect of the various condensers and resistances in the circuit has the effect of reducing the effective load resistance of the tube. The dynamic load line of the tube's characteristic curve will pass through the operating point but will have a slope such that it will have a cut-off characteristic at an input voltage less than zero and the distortion will be severe at modulation percentages where the instantaneous current approaches zero. Theoretically, the diode would not be able to handle successfully a signal having a high degree of modulation, but fortunately there is another factor that serves to nullify this effect.

It has been found that the maximum degree of modulation that can be placed upon an R.F. signal and be detected by the diode without distortion is equal to the equivalent impedance at the highest modulation frequency divided by the diode load resistance. When the efficiency of the detector is high, the load resistance offered to R.F. is equal to the load resistance, R, divided by the efficiency. Since the impedance is lower for A.C., the resistance offered to A.C. is equal to the effective resistance divided by the efficiency. The modulation percentage will therefore apparently be reduced and the distortion produced by the diode in the actual detection of highly modulated signals cut down.

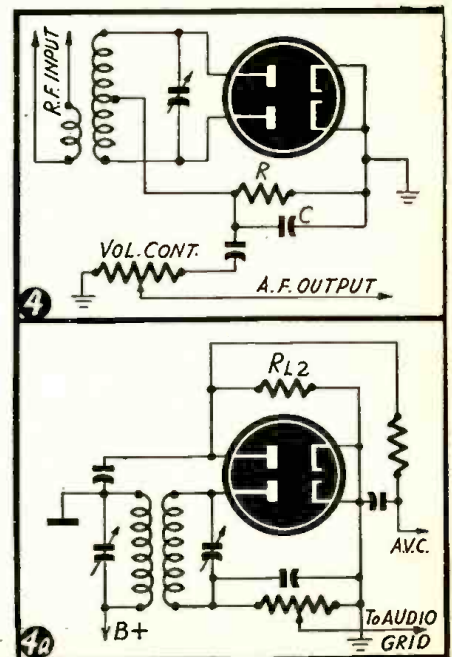

Fig. 4—Full-wave detector. 4-a—Detector and A.V.C. circuit for minimum distortion.

The tubes selected for diode detector service should have a low interelectrode capacitance and a low plate resistance. These conditions can be met by employing practically any of the especially designed diodes such as the 6H6 or the multi-purpose tubes as the 6Q7, 6B7, 6B8 and many others.

Fig. 4 illustrates the use of the diode as a full-wave detector. In this case, both halves of the input cycle are utilized. The output of this type of detector is only one-half as great as the output of the half wave-type for the same value of input voltage. This circuit has one advantage. Very little R.F. is placed across load resistor, due to the fact that the center-tap of the input inductance is at zero R.F. potential just as is the cathode.

In Fig. 4-a we see a circuit which has been developed to overcome the effects of shunting of high modulation frequencies caused by low value A.V.C. resistances and the usual coupling condenser and grid leak for the audio stage. In this case, the detector is a half-wave affair. The second diode plate is capacitively coupled to the plate of the preceding stage. A D.C. drop appears across its load resistor, RL2, to be used as A.V.C. bias. In this case, a section of the load resistor for the detector is employed as the grid leak and volume for the following audio amplifier stage. This method will supply ample audio voltage to the grid of the following stage, since the diode should not be operated at voltage inputs which are lower than 10 volts R.M.S. and this condition may be met by any receiver employing A.V.C.

The second part of this article will discuss triode detectors. It will appear in an early issue.

## A NEAT COIL REPAIR TRICK

By RAY FULTON

NOW that new, or even used, parts are so scarce, many substitutions are in order. In fact, they are the only answer in many cases. I have found the lowly one-watt resistor, duly accompanied by a coupling condenser, to be of invaluable assistance in quick replacement work.

Some time ago, a job came in with a burnt out I.F. transformer. Not being able to replace it in time to satisfy the customer, I substituted a 15,000-ohm, 1-watt resistor for the transformer winding, and connected a .0001 mfd. condenser from the plate of the tube to the grid of the next tube. That is to say, the condenser was connected between the "plate" and "grid" terminals of the I.F.T. It was found necessary to realign the I.F. stage due to differences in load, etc. Much to my surprise, the results were excellent, except for the faint sound of "birdies" on certain spots of the dial.

The same trick can be applied to an audio transformer. In the case of an audio transformer going out, the primary, of course is almost invariably the one to go. If a 50,000-ohm, 1-watt resistor is connected to where the primary was, and a .01 condenser is connected to the grid terminal of the stage fed by the transformer and to the plate of the input stage, the results will be as good as before as far as tonal quality is concerned, but the volume will be approximately one third less. This will not matter in most cases. It will be necessary simply to turn the volume control up a little more. If results are not quite good enough, there is still another trick. Reverse the position of the secondary of the transformer and the added resistor. That is, put the secondary in the plate circuit of the input tube and the resistor in the grid circuit of the next stage. In that case, you would have to use a 250,000-ohm, 1-watt resistor in place of the 50,000-ohm unit mentioned before.

Sometimes we have been unable to make a circuit oscillate and—short of adding turns and labor to the coil in question—a new tube or other expense not desired by the customer seemed the only answer.

Often this occurs because the filters have lost a little (or a lot) of their capacity. In many sets, the filter condensers often act as by-pass condensers from the B+ to ground. When their resistance increases, this by-pass effect is reduced somewhat with the result that there is no oscillation. If a .1 mfd. paper or mica condenser is connected from the B+ ground, the cause and effect will be eliminated in most cases.

# Electricity

Models range from 350 to 35,000 watts, A. C. types from 115 to 660 volts, 50, 60, 180 cycles, single or three-phase and 400, 500 and 800 cycles, single phase. D. C. types from 6 to 4000 volts. Also available in dual voltage and special frequency types.

ONAN

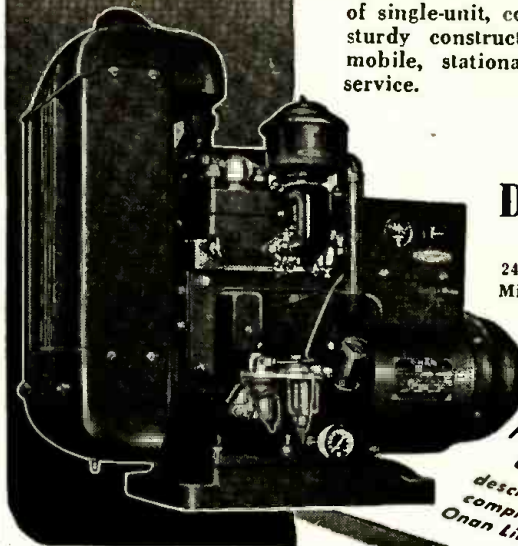

## FOR RADIO AND ELECTRONIC APPLICATIONS

ONAN ELECTRIC GENERATING PLANTS supply reliable, economical electrical service for electronics and television applications as well as for scores of general uses. Driven by Onan-built, 4-cycle gasoline engines, these power units are of single-unit, compact design and sturdy construction. Suitable for mobile, stationary or emergency service.

Model shown is from W2C series; 2000 to 3500 watts; powered by Onan-built, two-cylinder, water-cooled engine.

**D. W. ONAN AND SONS**

2418 Royalston Avenue  
Minneapolis 5 Minn.

Write For Folder 690-A describing complete Onan Line

## NEW INDUCTION HEATER

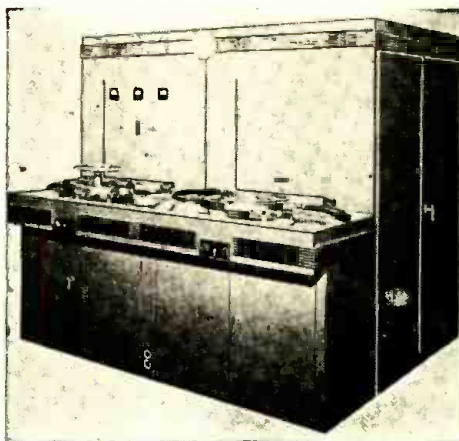

This new General Electric 50-kw electronic heater incorporates all of the important features of the 5-kw and 15-kw G-E heaters and, in addition, is capable of heat-treating much larger parts or the same size parts in less time. This heater is readily applicable for many different heating jobs merely by changing the induction-coil fixture.

The entire unit weighs approximately 6000 lbs. and is 84 inches wide, 94 inches deep, and 82 inches high over-all. The electronic heater cabinet is composed of two compartments, one of which contains an air-cooled transformer to step-up power supply voltage to the six rectifier tubes, and such accessory items as a contactor, a tap-changing switch, and filament transformers. The other compartment contains the high frequency components—a single water-cooled oscillator tube and a bank of water-cooled capacitors. The two compartments are separated by a heavy, protecting partition. Meters and controls are mounted on the two compartments.

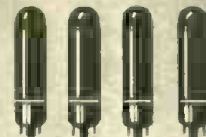

## 4 STANDARD TYPES

of Amperite Regulators replace over 400 types of AC-DC Ballast Tubes now in use.

Amperites are real REGULATORS... have patented Automatic Starting Resistor which prevents initial surge and saves pilot lights... Ask Your Jobber.

# AMPERITE

THE *Simplest* WAY TO REPLACE

# BALLASTS

WRITE FOR REPLACEMENT CHART

AMPERITE Co. 541 BROADWAY, NEW YORK, N. Y.

# One Central Source FOR Everything in RADIO and ELECTRONICS



**LARGEST STOCKS**  
**COMPLETE SERVICE**

**REPAIR and REPLACEMENT PARTS AVAILABLE** without priority

Over 10,000 items from all leading manufacturers . . . for the Armed Forces, Radio Training, Laboratories, Industry, Service Replacements.

New Parallel Resistance and Series Capacitance **CALCULATOR** Solves every-day problems — quickly! No. X37-960 Postpaid . . . **25c**



R. F. Resonance and Coil Winding **CALCULATOR** No. 37-955 Postpaid . . . **25c**

**6 Radio Books for 75c**

Dictionary of Radio Terms. No. 37-751	10c	Radio Data Handbook. No. 37-754	25c
Radio Circuit Handbook. No. 37-753	10c	Radio Builders Handbook. No. 37-750	10c
Radio Formulas & Data Book. No. 37-752	10c	Simplified Radio Servicing. No. 37-755	10c

All Six Books No. 37-799 . . . **75c**  
Write for Quantity Prices

**ALLIED RADIO CORP., Dept. 2-H-5**  
833 W. Jackson Blvd., Chicago 7, Ill.

Please send following books (..... enclosed)

<input type="checkbox"/> FREE Guide	<input type="checkbox"/> 37-750	<input type="checkbox"/> 37-752	<input type="checkbox"/> 37-754
<input type="checkbox"/> Calculator 37-955	<input type="checkbox"/> 37-751	<input type="checkbox"/> 37-753	<input type="checkbox"/> 37-755
<input type="checkbox"/> Calculator X37-960	<input type="checkbox"/> No. 37-799 (All 6 Books)		

Name.....  
Address.....  
City.....State.....

**ALLIED RADIO**

## PARASITIC OSCILLATIONS

(Continued from page 700)

feature is desirable, the screen supply should be of the series-dropping variety. Thirty thousand ohms is the correct value for a 6AB7/1853 in the R.F. stage of a broadcast or all-wave set, while 60,000 ohms is about right for the 6AC7 as a U.H.F. amplifier. In single-stage R.F. or I.F. amplifiers, 40,000 ohms may be used as the screen drop with any of the other tubes, while if a two-stage amplifier is used it is advisable to use a little higher resistance in the first tube's screen. In any case the screen voltage should exceed 150 for maximum gain. This should be borne in mind when designing voltage divider networks if this type of screen supply is to be used. The resistors should be proportioned to deliver a voltage of between 150 and 225 volts. At least .1 mfd. should by-pass the screen to ground.

In passing, a word should be said about the suppressor. This should be grounded directly rather than connected to the cathode. A direct ground connection makes for more stable operation.

Finally we must discuss the elimination of feedback from the plate circuit into the "B+" line. Another decoupling filter is necessary here and may consist of a 1000-ohm resistor and a paper by-pass of at least 1 mfd. For extreme cases 2000 or even 5000 ohms may be used but the voltage drop caused by these resistors may be objectionable. Another method of decoupling where supply voltage is at a premium is to use a 2.5-millihenry R.F. choke in place of the decoupling resistor, since this choke presents only a few ohms D.C. resistance while offering a very high impedance to R.F. voltages.

Fig. 3 shows an I.F. stage which will display very little tendency to generate parasitic oscillations.

When supplied with 300 volts from a typical A.C. power supply, the plate voltage will be about 290 volts, the screen voltage 190 volts, and the bias 2.5 volts, which conditions will allow very high gain to be realized. Further insurance against parasitics may be obtained by connecting the high end of the screen resistor to the other side of the plate decoupling filter as in Fig. 4; and in cases where extreme care must be taken to avoid parasitics, as when the 6AC7 is used, the circuit of Fig. 5 may prove desirable.

Finally, if the stage is to be used in an A.C.-D.C. set where the limiting factor is the supply voltage (and parasitic elimination need not be so complete due to the lower gain occasioned by the lower plate and screen potentials) the circuit of Fig. 6 has been found to be very efficient. All of these circuits, of course, even though they are shown as I.F. amplifiers, may be converted readily for R.F. amplification merely by the substitution of proper tuning components. In either class of service they will perform with high efficiency and gain and little tendency to oscillation.

Considerable mention has been made in many articles of the importance of parts placement and grounding, but a specific plan of parts placement has seldom been given. The best idea is to mount two terminal strips, one on each side of the tube socket. On one of these the A.V.C. decoupling resistor may be mounted while the other may serve to support the resistor or choke used in the plate decoupling filter. The screen resistor, cathode resistor, and the R.F. wiring may then be installed, keeping all these items close to the chassis

and leaving the space covering the bottom of the tube socket free.

In this space, and sitting right on the tube socket prongs, the cathode by-pass, screen by-pass, and plate decoupler by-pass condensers may be mounted side by side with the lead of each condenser marked "outside foil" grounded. These three .1-mfd., or bigger, condensers should completely cover the bottom of the tube socket, so that with the wiring completed no R.F. or I.F. socket should be visible when looking into the underside of the chassis.

Since the outside foil—i.e., the conducting layer nearest the surface of the condenser—of each of these by-passes is grounded, the whole assembly constitutes a complete and very efficient shield, which fits closely over the bottom of the tube socket and effectively reduces stray capacities between the input and output circuits and troubles due to other neighboring stray fields. The condensers, of course, must be of the tubular paper variety in order for this method of obtaining shielding to work, since other types may not have their conducting elements placed in the same way.

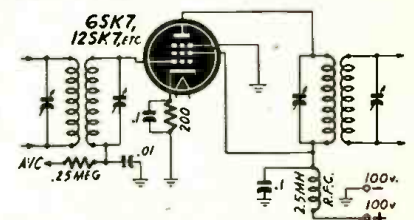

Fig. 6—Filter for low voltage uses a choke.

The A.V.C. decoupling filter by-pass may be placed to one side of the tube socket, and by grounding its outside foil and placing it on top of the grid lead if a single-ended type tube is used, additional shielding of this sensitive circuit may be obtained.

A determining factor in the success of a receiver is the method in which the different grounds are made. Although in a schematic design, a lead to be grounded is simply indicated by the familiar symbol drawn at any convenient place on the diagram, actually the point on the chassis at which each individual lead to be grounded is connected is of paramount importance in the operation of any radio equipment, and most particularly receiving equipment, especially on the U.H.F. Even in audio amplifiers, proper grounding can increase overall gain slightly and may often spell the difference between high hum level and noiseless operation. The author has seen a seemingly hopeless case of parasitic trouble in an FM receiver cured simply by unsoldering the lead grounding the No. 1 pin of the 6AC7 R.F. amplifier from the chassis, moving it over about half an inch, and soldering it down again. All this may sound very impressive, but the question is, how can one be sure that one's grounds are correct. The answer is given in a few simple rules, which now follow:

Avoid eddy currents in the chassis which may set up abnormal voltage drops and electromagnetic fields. Eddy currents may be set up between any two points on the chassis where wires are grounded, sometimes reaching amazing values. The solution should be obvious—to have as few separate ground points as possible. From this point of view, a single point in the center of the chassis to which all ground leads are connected would be ideal, but

this makes for long ground leads. They would probably prove more detrimental than eddy currents, especially at high frequencies where long leads can show appreciable inductive reactance.

A length of heavy bus-bar running around the chassis and grounded to it at one point only while all ground connections are made to this wire is very effective, but there is a simpler system which may be used to give just as good results. This is to pick a point near each tube to which all ground connections associated with that tube are made. Thus in a set of seven tubes there should be seven points on the chassis to which grounds are made. Grounds of the tuning-eye tube may be made to the same point as those from the second detector.

"A stage" may be considered as all the circuit components included between the input coupling to the tube and the output coupling. Thus in the I.F. stage of Fig. 4, the A.V.C. decoupling filter by-pass, the cathode resistor and by-pass, the screen by-pass, the suppressor and the plate decoupling filter by-pass should all be grounded by short leads to a single point located conveniently near the tube. This procedure should be carried out very completely, treating audio stages the same way, and even regarding the power supply and its immediately associated filter as a stage. If this is done, no trouble will be experienced with effects due to eddy currents. Since each stage is more or less a complete circuit in itself eddy currents passing along the chassis between two stages are not likely to cause trouble in either one.

In closing, we may look at the audio section. This part of the set is usually a minor section in a communications receiver designed more for sensitivity and selectivity than for tone and power output. It is generally the most trouble-free and is also generally assumed to be such by the home constructor. However, there is one type of audio parasitic which may easily develop in a home-constructed audio system and

which the builder may assume to be an R.F. disturbance, spending hours of needless hunting in the wrong place. The audio trouble may be easily distinguished by its "Put-put" sound in the output. Because of this characteristic sound, this parasitic is referred to as a "motorboat," although sometimes it may be of so high a frequency that the individual pulses will be indistinguishable, in which case it may become a tone or whistle. An infallible test is that tuning will have no effect on the sound.

"Motorboating" is a relaxation oscillation caused by the audio system acting in whole or in part as a multi-vibrator. Usually a couple of low-level, high-gain stages will be found responsible. The first culprit may be found by grounding the audio grids one after another, starting at the input of the system, until the parasitic stops.

Since a minimum of two stages in cascade is required for a multivibrator circuit to be set up, it will usually be found that if the first stage found to be responsible for the oscillation is eliminated from the multi-vibrator set-up, the trouble will cease. This elimination may be invariably accomplished by a decoupling filter in the plate supply lead to the offending stage. For audio work the filter may take exactly the same form as the one previously described for R.F. and I.F. use, but will use different values of R and C. A resistor of 10,000 ohms and a 16 mfd. electrolytic condenser should cure any case, while for extreme troubles 20,000 to 50,000 ohms may be used without producing a voltage drop detrimental to the operation of a low level audio voltage amplifier.

By the use of the above methods, it should be possible to eliminate unstable operation and parasitic oscillation in any stage of the receiver. It is to be hoped that these suggestions may help to reduce this sort of trouble in home-built sets and may lead to obtaining higher gain from stages that might otherwise have to be operated at reduced voltage.

## FILAMENT WELDER SAVES TUBES

THE shortage of parts and tubes has not been accompanied by a shortage of new ideas and means of keeping radio receivers in operation. For example, a worthwhile percentage of burned out tubes have been returned to service by welding their filaments.

A high voltage is usually connected across the defective filament for a short period of time. Unfortunately, it is altogether too easy to keep the voltage on too long, thus not only repairing the tube but immediately burning it out again . . . this time for good.

A far greater chance for making a good weld is contained in an invention by Norman A. Hendry of Portland, Mich. (U.S. Patent No. 2,371,327). Instead of connecting the voltage source directly to the tube, he first charges a condenser and then discharges it through the filament to be repaired. In this way there is direct control over the maximum value of the current flowing as well as the interval of time. Further, the exponential nature of the discharge permits tempering of the filament, which might otherwise become brittle and susceptible to overload.

Correct values to use for different types of filament have been discovered by Mr. Hendry after experiment and are listed in the table.

A preferred layout includes a source of direct current, several taps for desired outputs and a switching arrangement for

charging and discharging the condenser. The circuit can be easily and conveniently built into a cabinet with provision for welding tubes with different bases.

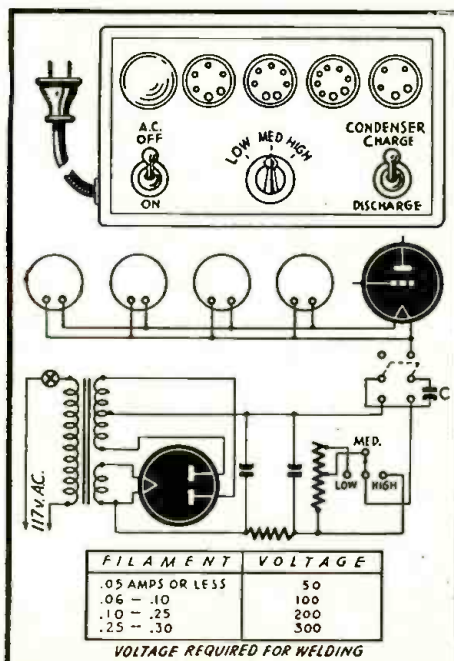

734110MEAN

1700

ANSWERS

TO YOUR HARDEST PROBLEMS



1178 Illustrations  
1000 Pages  
130 Tables.—105 Graphs

### GET THE ANSWERS NOW!

Here, in one big volume, you'll find all the time saving answers to your radio problems . . . and time saved is MONEY EARNED. Written in easily understood language. Yet accurate enough for an engineer. Completely revised and cross indexed for quick reference, this handy reference book for your tough jobs covers radio transmission and reception, public address systems, television, photocells and data on their important parts. It's a book you'll always use. And . . . it's only \$5.00

ANOTHER TIME SAVING BOOK!  
ELECTRICAL AND RADIO DICTIONARY. Over 3800 definitions of technical words and terms used in all branches of radio and electricity. 300 Pages—550 Illustrations. \$2.50

GATEWAY PUBLISHING COMPANY

53 W. Jackson—Dept. RC-8  
Chicago 4, Ill.

### Clip This Coupon NOW

- Send me the new Drake Cyclopeda IMMEDIATELY.
- And the 300 Page Radio Dictionary.

Name \_\_\_\_\_  
Address \_\_\_\_\_  
City \_\_\_\_\_ State \_\_\_\_\_

# RADOLEK

## Radio-Electronic Service Parts



Large stocks assure the finest and most complete selections of all available items at lowest prevailing prices. Thousands of active buyers depend on us for their entire Radio repair and replacement requirements. Because we understand service problems, every order is expedited for delivery in double quick time. Everything we do is planned for convenience and satisfaction to our customers. You will find it profitable to make Radolek your buying headquarters.

### FREE BUYING GUIDES

Because of existing conditions we keep our customers right up to the minute on available merchandise by releasing supplements frequently instead of sending our regular Big Profit Guide once a year. Send the coupon now to get these Free Buying Guide Supplements as they are issued.



### FAST SERVICE!

RADOLEK CO., Dept. C-105  
601 W. Randolph St., Chicago 6, Ill.

Please send FREE Buying Guide Supplements

NAME \_\_\_\_\_  
ADDRESS \_\_\_\_\_

ORDER FROM RADOLEK

## LEOTONE MONTHLY SPECIALS!

Brand new R.C.A. #200A tubes in sealed cartons (Ideal detector and amplifier) .....2 for 25c  
 The following tubes in perfect condition, but not in sealed cartons. Guaranteed for 90 days: 26, 27, 46, 56 and 40 .....29c each  
 Number 40 tube can be used in place of #71A.  
 DeJur 3 stage wired resistance coupled amplifier chassis base, including 3 sockets, 8 heavy duty binding posts and 6 metalized resistors ..... \$1.29  
 Western electric platinum point telegraph keys...49c  
 Earphone head bands, complete with forks.....59c  
 Western electric key and buzzer.....\$1.75  
 Medium size battery clips—2½ inches long..4 for 25c  
 Single wire connectors—1 inch long.....4 for 25c  
 One tube Muller battery set including brand new R.C.A. tube. Housed in wooden cabinet 7½ x 11 x 7½ deep .....\$2.95  
 Bakelite tubing: 3 inches O.D.—2¼ long...8c each

Terms: No orders for less than \$2.00 accepted. 20% deposit is required on all orders.

The house of a million parts!

What do you need?

### LEOTONE RADIO COMPANY

63 DEY ST. NEW YORK

(Cone & Coil Makers Since 1927)

## Learn RADIO-ELECTRONICS-TELEVISION



**12 WEEKS TRAINING IN COYNE SHOPS WHERE YOU "LEARN-BY-DOING"**

Trained Radio-Electronics men needed now. They will be needed too when the war is over. Tremendous expansion in Radio, Electronics, Frequency Modulation and Television predicted—a world of new opportunities. Get Radio Training in the Coyne Shops in Chicago now, and BE READY

### Ill Finance Your Training

If you are short of money, you can start now and pay most of your tuition after you graduate. Many earn while learning. Free Lifetime Employment Service to graduates. EXTRA training in INDUSTRIAL ELECTRONICS—no extra cost.

#### FREE BOOK

Whether you're 16 or up to 40, get the facts. Big illustrated book tells about your future in Radio-Electronics-Television. Mail coupon today.

**VETERANS!** Coyne is equipped to train those who qualify for training under the G. I. Bill of Rights. Check coupon. We also have facilities for men with physical disabilities whether due to war or other causes.

H. C. LEWIS, Pres., RADIO-ELECTRONICS DIVISION  
 COYNE ELECTRICAL SCHOOL  
 500 S. Paulina St., Dept. CS-84, Chicago 12, Illinois

Send me FREE BOOK on COYNE RADIO-ELECTRONICS TRAINING and details of "Pay-After-Graduation" Plan.  Send physical disability plan.  Veteran—send special G. I. Bulletin.

NAME.....

ADDRESS.....

CITY..... STATE.....

## UNIVERSAL MIDGET TOOL SET

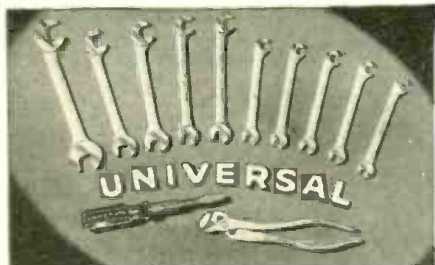

**Dandy 12 pc. Set:** 10 Open-end Wrenches—3/16" to 7/16". Midget Unigrip Pliers. Unigrip Screwdriver. **\$12.95 Only**

Remit with order. Immediate shipment.

**UNIVERSAL TOOL COMPANY** 1527 Grand Kansas City 8, Mo.

## NEW AUTOMATIC RADIO COMPASS

(Continued from page 697)

switch marked VOICE-CW may be used to energize the CW relay for tone-modulated reception of radio-telegraph signals.

A streamlined housing mounts the loop in such a manner that it is rotatably driven by the 400-cycle loop driving motor. Directly coupled to the loop is an Autosyn transmitter (MO-26) which electrically transmits the angular position of the loop to the indicator or indicators.

The loop directing circuits operate to cause the loop drive motor (MO-27) to rotate the loop in a given direction according to the phase of the radio compass output voltage as referred to the 48-cycle oscillator voltage. Reversal of the phase of the radio compass output will produce a reversal of the direction of loop rotation. When the loop is on its null, the radio compass output is zero, with the result that no excitation is supplied to the loop drive motor.

Two switching tubes (loop control) are connected with their grids in push-pull to the diode rectifier load impedance. Thus, each grid receives alternate halfwave negative pulses of 48-cycle voltage. In addition, the center tap of the diode rectifier circuit is connected to one end of the compass output transformer secondary. The opposite end of this transformer winding is connected to a variable bias control which varies the sensitivity of the loop director circuit. If the radio compass circuits are assumed to be delivering a 48-cycle voltage to the compass output stage, then the grids of the two switching tubes are receiving simultaneous variations in voltage.

In the control tube in which the phase of the negative pulse from the diode rectifier is the same as that of the positive peak from the compass output secondary, little or no plate current will flow. This is because the positive peak is limited by the suppressor circuit to a value smaller than necessary to overcome the concurrent negative peak from the diode rectifier circuit. The other control tube will receive no nega-

tive peak at this same instant. Thus, the positive peak from the compass output secondary circuit will cause plate current to flow in this tube, since the normal bias supply from the sensitivity control is insufficient to cut off the plate current for even small values of grid control voltage from the compass output secondary.

Under conditions of no output from the radio compass, the bias voltage is just sufficient to prevent excessive hunting of the loop because of random noise from the compass output circuit. The diode suppressor (comp. out limiter) in this circuit also helps to minimize loop action due to noise pulses.

The compass output circuit is tuned to the 48-cycle audio-oscillator frequency to reject unwanted voice frequencies from the loop director circuits. The overall phase shift of this system will change very slowly, should the 48-cycle audio-oscillator vary from its assigned value under any combination of service conditions.

Each switching tube plate connects to separate saturable reactors (sat reac 168) which, in turn, connect together and then to the B-plus supply of the radio compass receiver.

The two secondary windings in each of the saturable reactors are connected in a series opposing manner, and balanced so that the 400-cycle per second voltage impressed thereon is cancelled out completely in the primary plate circuits. The A.C. windings of the saturable reactors are connected in series, with the free ends connected to the two ends of the power transformer secondary which supplies power for the high impedance winding of the loop drive motor. The junction of the A.C. reactor windings is connected to a phasing capacitor C-30B whose other terminal connects at all times to ground (except when the function selector of the control box in control is in the "loop" position).

The loop drive motor has two fixed windings, and is connected so that the low-

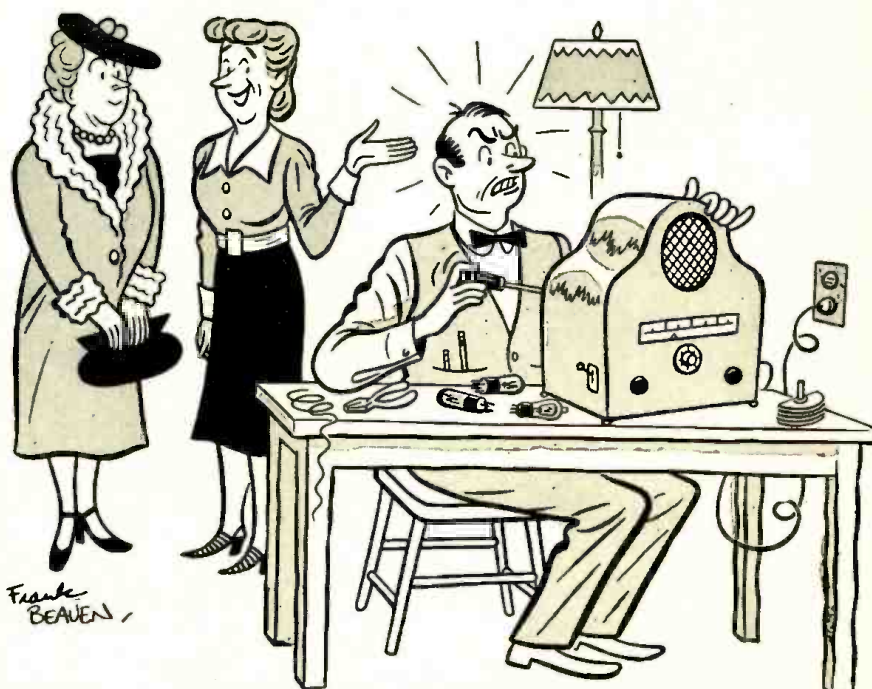

Frank BEAVER

Suggested by: Rodney Hudson, Falconer, N. Y.

"He calls it his wonder radio—he wonders if it will ever work!"

impedance winding is continuously excited from the 400-cycle per second power transformer through a suitable phasing capacitor. When the high-impedance winding (HI-Z) is supplied with a current whose phase difference, with respect to the current in the low-impedance winding, is 90 degrees, rotation of the motor armature takes place. The direction of rotation is determined according to whether this phase difference is 90 degrees lead or lag.

Where no voltage is applied to the grids of the switching tubes, the current flowing to the high-impedance motor winding through both saturable reactor secondaries is practically zero, since the secondaries present equal impedances to the flow of current through them. Their impedance at 400-cycles per second is high, and the phase of the currents is respectively opposite. These effects produce cancellation of the two currents in the return lead to the center-tap of the power transformer secondary. As the high-impedance winding (HI-Z) of the motor is situated in this lead, the current through the motor winding is substantially zero.

When plate current flows in sufficient amount through a saturable reactor primary winding, its secondary reactive component diminishes because of the iron core saturation by this flow of D.C. in the primary. Since the reactors are designed to saturate at a very low value of direct current in the primary windings, the resultant impedance of a saturated reactor secondary is extremely small as compared to the reactance at 400-cycles per second when not saturated. Since one switching tube works at a time, the resultant saturating of the reactor in its plate circuit allows the passage of considerable current through the high-impedance motor winding, with subsequent rotation of the armature. The phase of this current is in quadrature with respect to the current through the low-impedance winding (LO-Z), due to correction applied by the phase correction capacitors.

If a voltage of opposite phase is applied to the tune compass output amplifier, the results are the same, except that the other switching tube is operated, saturating its reactor and supplying the high-impedance motor winding with a 400-cycle current, opposite in phase, which causes the loop drive motor to turn in the other direction.

By applying a suitable current to the motor through an isolating choke L<sub>o</sub>, direct current damping of the loop drive motor is obtained, which insures freedom from hunting around the null point. Overshooting of the bearing is considerably checked by the differential action of the switching tubes when approaching the bearing point in the following manner:

The D.C. bias is so adjusted that some plate current flows in both switching tubes when there is no signal from the radio compass output stage. With a 48-cycle voltage supplied by the radio compass to the loop director input circuit, the grid of the switching tube under control is driven farther in the negative region by the combined action of the compass output voltage and the grid blocking voltage from the audio oscillator rectifier circuit.

Then the switching tube plate current is at a maximum, and decreases gradually to practically zero when the loop reaches the bearing position. This gradual decrease takes place when the loop is a few degrees from the bearing, and slows down the speed of the loop sufficiently to prevent overshoot.

The inherent accuracy of the Fairchild SCR-269-F is said to be such that its bearing indications are accurate to within  $\pm 3$  degrees.

## Now... ALIGNING KITS AVAILABLE TO DEALERS & SERVICEMEN

**Radiomen:** Here's an opportunity to acquire high quality approved all-purpose Neutralizing and Aligning Kits. Order Now.

### G-C TE-45A NEUTRALIZING KIT

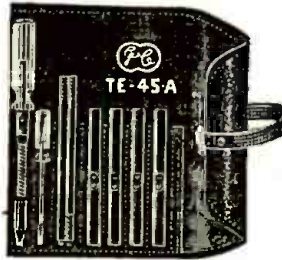

Approved by U. S. Army Signal Corps. The all purpose kit used extensively by Signal Corps.

Kit contains:—1—5" Small Screw Driver  
1—No. 5019 Flexi-Driver  
1—No. 5003 Tool  
1—No. 5000 Tool  
2—No. 5051 Tool  
2—No. 5052 Tool  
1—Leatherette Case

No. 5021 Kit ..... Price \$4.50

### G-C VEST POCKET ALIGNING KIT

A very handy all purpose aligning kit.

Kit contains:—  
1—5012 Alligator and Hex Wrench  
1—5000 Screw Driver  
1—5003 RCA Screw Driver  
1—5004 Screw Driver  
1—Leatherette Case

No. 5022 Kit ..... Price \$1.80



### G-C NX ALIGNING KIT

Approved by U. S. Army and Navy. Very Handy all purpose aligning and Neutralizing kit.

Kit contains:—  
1—5004 Screw Driver  
1—5011 Alligator Wrench  
1—5017 Double End Wrench  
1—5015 Combination Tool  
1—5016 Combination Tool  
1—Leatherette Pocket Case

No. 5020 Kit ..... Price \$3.90



MAIL OR PHONE YOUR ORDER NOW!

## RADIO ELECTRIC SERVICE CO.

OF PENNSYLVANIA  
N.W. COR. 7th & ARCH STS.  
PHILADELPHIA 6, PENNA.

Phone:—  
LOMBARD 6177  
LOMBARD 1951

## SPEED UP REPAIRS WITH THESE G-C AIDS!



FREE STEEL CABINET

### G-C DIAL BELT KITS

Exact replacement woven fabric belts. Easy to install—no stretching—no adjustments—a perfect fit everytime. Kits come with 25, 50, 100, 200 or 300 belts.

## Get This New FREE Dial Belt — Drive Cable and Cabinet Repair Guide!



Pocket size 68 page book contains thousands of listings, specifications—time saving service instructions. Invaluable to every radio man. Get a copy from your jobber. If he cannot supply you, write us.

Immediate delivery on G-C Belts and Cables

Order From Your Radio Parts Jobber  
ALWAYS ASK FOR G-C PRODUCTS



**GENERAL CEMENT MFG. CO.**  
ROCKFORD, ILLINOIS

### SERVICEMEN ATTENTION

50L6, 12SA7, 12SQ7, 25Z5, etc. Forget the shortage of above and similar tube types by availing yourself of our tube repair service. Tubes are fully tested after repairing in radios. Send no money. Repaired tubes returned C.O.D. Only 25c each or 20 tubes repaired for \$4.00. Ship us a boxful today and take advantage of OUR LOW PRICE. Minimum order \$2.00.

Radio Service, 307 Pipestone, Benton Harbor, Mich.

### Ted McElroy

World's Largest Manufacturer of Wireless Telegraphic Apparatus

COMPLETE CENTRAL OFFICE EQUIPMENT

**McElroy Manufacturing Corp.**

82 Brookline Avenue • Boston, Massachusetts

# HARD-TO-GET PARTS

## METERS

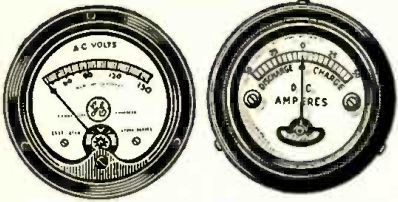

GENERAL ELECTRIC, A.C. Voltmeter, 0 to 150 Volts, type AO22, 3 1/2" flush mounting, Ship. weight 2 lbs.  
**ITEM NO. 153**  
**YOUR PRICE \$9.75**

GENERAL ELECTRIC, A.C. Ammeter, 0 to 150 Amperes, type AO22, 3 1/2" flush mounting. This is a 5-ampere A.C. meter and may be used as such with no changes. For the 150-ampere range, a current transformer is necessary. Shipping weight 2 lbs.  
**ITEM NO. 154**  
**YOUR PRICE \$8.75**

HOYT D.C. Ammeter, 50-25-0-25-50, type 531, 1 3/4" flush mounting, weight 1 lb.  
**ITEM NO. 155**  
**YOUR PRICE \$1.75**

## ULTRA MAGNET

LIFTS MORE THAN 20 TIMES ITS OWN WEIGHT

### LITTLE GIANT MAGNET

Lifts 5 lbs. easily. Weighs 4 oz. Made of ALNICO new high-magnetic steel. Complete with keeper. World's most powerful magnet ever made. The exciting hobbyist and hobbyist will find hundreds of excellent uses for this high quality permanent magnet. Measures 1 1/2" x 1 1/2" x 5/8" lbs.  
**ITEM NO. 159**  
**YOUR PRICE \$1.50**



## GENUINE MICROPHONE TRANSMITTERS

These are regular "telephone transmitters" of the type used on wall telephones. Taken from a large telephone supply company's overstock, these fine mikes offer a grand opportunity to obtain a splendid unit for little more than the price usually asked for a simple "microphone button."  
 The amateur experimenter and telephone mechanic will find a variety of uses for these excellent microphones. They work perfectly on 2 dry cells.

Can be used on P.A. systems for voice transmissions, in call systems and intercommunications sets. With telephone receivers (radio headphones will do) they may be made into short-line telephone circuits, such as house-to-house or farm-to-farm telephone lines. You can use them to talk through your own radio, or as concealed dictaphone pick-up units for listening to conversations in a distant room or building. The telephone mechanic will find them useful replacements on battery-operated rural telephone lines.

THESE ARE GENUINE TRANSMITTERS, MADE BY KELLOGG, WESTERN ELECTRIC AND STROMBERG-CARLSON, excellent in appearance and operation. A remarkable value, and one seldom offered in these times. Ship. Wt. 1 lb.  
**ITEM NO. 160**  
**YOUR PRICE \$1.50**

## AMAZING BLACK LIGHT!!

Powerful 250-Watt Ultra-Violet Source



The best and most practical source of ultra-violet light for general experimental and entertainment use. Makes all fluorescent substances brilliantly luminous. No transformers of any kind needed. Fits any standard lamp socket. Made with special filter glasses permitting only ultra-violet rays to come through. Brings out beautiful fluorescent hues in various types of materials. Great for amateur parties, plays, etc. Obtain unique lighting effects. Outb

only. Ship. Wt. 2 lbs.  
**ITEM NO. 87**  
**YOUR PRICE \$2.45**

## WESTERN ELECTRIC BREAST MIKE

This is a fine light-weight aircraft carbon microphone. It weighs only 1 lb.  
 Mike comes with broadcast mounting and has 2-way swiveling adjustment so that it can be adjusted to any desired position. There are 2 woven straps; one goes around neck, the other around chest. Straps can be snapped on and off quickly by an ingenious arrangement.  
 This excellent mike can be adapted for home broadcasting or private communication systems. By dismounting broadcast plate, it can be used as desk mike.  
 Comes complete with 8-foot cord and hard rubber plug. Finished in sherdurized plate, non-rustable.  
 Shipping weight, 2 lbs.  
**ITEM NO. 182**  
**YOUR PRICE \$2.55**



**HUDSON SPECIALTIES CO.**  
 40 West Broadway, Dept. RC-8-45, New York 7, N. Y.  
 I have circled below the numbers of the items I'm ordering. My full remittance of \$ (include shipping charges) is enclosed (NO C.O.D. ORDERS UNLESS ACCOMPANIED WITH A TELEPOSTAL OR my deposit of \$ is enclosed (20% required), ship order C.O.D. for balance. NO C.O.D. ORDER FOR LESS THAN \$5.00. (Now U. S. stamps, check or money order accepted.)  
 Circle Item No. wanted: 163, 164, 165, 159, 160, 87, 152

Name \_\_\_\_\_  
 Address \_\_\_\_\_  
 City \_\_\_\_\_ State \_\_\_\_\_

# POWER SUPPLY DESIGN

(Continued from page 703)

cated and involve consideration of the voltage source impedance, the resistance of the rectifier tube, the input capacity, and the leakage reactance in an involved relationship. A few simple graphs will illustrate the effects of this input condenser in a manner which will be fully satisfactory for all practical uses.

Fig. 3 is a graph illustrating the variation of voltage for various load currents and different values of capacity utilized as input condensers. We note that increasing current will lower the voltage, thus causing poor regulation. The wide space occupied by the curves further indicate the poor regulation as also does the percentage voltage change for varying loads. The use of this chart is self-explanatory and no difficulty is likely to be experienced by anyone who understands radio fundamentals.

The graph in Fig. 4 indicates the ripple percentage resulting from various values of capacity and load resistance. We note here that in all of these calculations the effect of both capacity and load resistance and load current are very important in their effects on ripple.

The graphs in figures 3 and 4 are both for 120-cycle ripple frequency as would be the case for full-wave or bridge rectifiers. The use of condenser input for half-wave systems is not recommended except under the conditions previously noted. One effect of condenser input is to produce a higher peak voltage and current on the rectifier tube or tubes than is imposed with the choke input system. The ratio of peak to average plate tube current is higher.

The most important considerations involved in the calculation of filter output voltage using condenser input are the source impedance, which consists of the leakage reactance and resistance of the transformer, the tube resistance, and the resistance of the load; the value of the condenser not being of prime importance. The important considerations in reference to filtering ability and the reduction of ripple voltage are the actual capacity and the load resistance. Later on in this discussion an example of the calculation of a condenser input filter shall be given and the means of using these charts and graphs will be readily apparent.

We may now proceed to the choke input filter consisting of a choke followed by a condenser as shown in Fig. 5. The formula for the determination of the amount of ripple voltage that this type of filter will pass with various values of L and C is:

$$E_r \text{ across load} = \frac{E_r \text{ at input}}{(2\pi f)^2 LC} \quad (1)$$

As the ripple factor is what we are interested in we will work out the equation for this factor. Let us assume a full wave or bridge rectifier, then  $E_r$  at the input to the filter will be  $.667 E_{dc}$  and  $f_r$  will be 120 cycles. Substituting these values in this equation (1) we find our next equation to be:

$$E_r \text{ across load} = \frac{.667 E_{dc}}{(6.28 \times 120)^2 \times LC} = \frac{.667 E_{dc}}{568500 LC}$$

$$= \frac{.0000012 E_{dc}}{LC} = 10^{-7} \frac{12 E_{dc}}{LC}$$

But, as the factor we desire is the ripple factor which is equal to  $E_r$  divided by  $E_{dc}$ , we must divide this equation by  $E_{dc}$  to find the ripple factor. Doing this we have:

$$\text{Ripple factor} = \frac{E_r \text{ across load}}{E_{dc}} = 10^{-7} \times \frac{12 E_{dc}}{LC} \times \frac{1}{E_{dc}}$$

$$= 10^{-7} \times \frac{12}{LC} \quad (2)$$

In use this formula should be used for full-wave or bridge rectification only as the

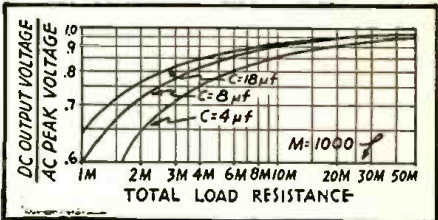

Fig. 3—D.C. output vs. A.C. peak voltages.

ripple frequency has been assumed to be 120 cycles and the peak value of the alternating current component of the rectified direct current is taken as being  $.667$  of the direct current voltage. For half-wave calculating the ripple frequency will be 60 cycles and the above equations can be worked out with that value merely by substitution of 60 in place of 120 in the formula. Value of the peak alternating current component will vary with the load drawn but a figure of  $.7$  can be used in calculations. For heavy loads and to allow a margin of safety it would be better to use a higher figure. About  $.8$  should be fully satisfactory. It is difficult to give an exact figure, but for all practical uses and purposes, those given above will prove fully satisfactory.

In all our choke-input filter designs it is supposed that the input inductance is of sufficient size as to maintain a continuous flow of current through the circuit under operating conditions. This is a function of the actual inductance, the resistance of the load, the alternating current component of

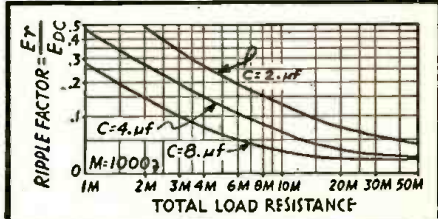

Fig. 4—Ripple at filter input and output.

the rectified wave, and the direct current voltage output of the rectifier system. As the last two mentioned figures represent a constant for any given type of rectification, a simple formula will show the minimum amount of inductance required to satisfy the conditions of maintaining current flow throughout the entire 360 electrical degrees: For 60 cycle ripple:

$$L = \frac{R_L}{565} \quad (3)$$

For 120 cycle ripple:

$$L = \frac{R_L}{1130} \quad (4)$$

Unless these minimum amounts of inductance are used the formulas and graphs given for choke input filter design cannot



be used with accuracy. Imperfect filtering and high peak tube currents will result from a deficiency of inductance, with possible damage to the rectifier tubes. In the case of a varying load on the rectifier and filter system the conditions of minimum inductance must be observed at all times. To accomplish this it may be desirable to connect a bleeder across the output of the filter in order to maintain a minimum amount of current flow. Another method often used is to use a "swinging choke" in the input of the filter. A swinging choke has a relatively high inductance for low current, which drops with increasing current. By reference to the proper formula, which will depend on the type of rectification, and by use of the maximum and minimum inductance values, it is easy to select the proper choke so that flow will be maintained for all values of current.

Our next consideration is the two-section filter shown in Fig. 1 or 2. In this case, we have merely used two single sections, one following the other. The amount of ripple voltage present at the output of this type of filter is calculated from the following formula:

$$E_r \text{ across load} = 10^{-14} \frac{206 E_{dc}}{L_1 C_1 L_2 C_2} \quad (5)$$

and to find the ripple factor we have:

$$\text{Ripple Factor} = 10^{-14} \frac{L_1 C_1 L_2 C_2}{206} \quad (6)$$

In working with this formula it is best to have the product of the first section of the filter approximately equal to the LC product of the second section. The above formulas, numbers (5) and (6) are for use with 120-cycle ripple frequencies. For 60-cycle ripple frequencies (as would be encountered with half wave rectification) the numerator of both fractions would be changed from 206 to 34 and the fractional multiplier changed from  $10^{-14}$  to  $10^{-12}$ .

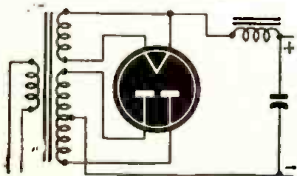

Fig. 5—Power supply with choke-input filter.

Another method of effective filtering commonly used for low-current applications is that in which resistors replace the chokes in the standard type of filter. This type of filtering is advantageous because resistors are lower in cost than inductances, thereby lowering the cost. The amount of filtering is a function of the load resistance and the values of the filter components. An approximation is given for the amount of filtering by the following formula:

$$\text{Ripple factor} = 10^{-5} \frac{177}{RC} \quad (9)$$

This formula is for 60-cycle ripple frequency.

$$\text{Ripple factor} = 10^{-5} \frac{88}{RC} \quad (10)$$

This second formula (8) is for 120-cycle ripple frequency as would be present in full wave and bridge rectifiers. It must be remembered that the resistance introduced into the circuit by the use of a resistor-capacitor filter will lower the available voltage at the filter output. The voltage drop will increase with increasing current. The above formulas are for a single-section filter consisting of one resistor followed by one condenser.

Let us solve two problems: the first dealing with a single section choke input filter;  
(Continued on following page)

Available for Prompt Delivery on Priority of AA3 or Better!  
The New Model 450

# TUBE TESTER



**SPEEDY OPERATION**—assured by newly designed rotary selector switch which replaces the usual snap, toggle, or lever action switches.

### Specifications:

- ★ Tests all tubes up to 117 Volts including 4, 5, 6, 7, 7L, Octals, Loctals, Bantam Junior, Peanut, Television, Magic Eye, Hearing Aid, Thyratrons, Single Ended, Floating Filament, Mercury Vapor Rectifiers, etc. Also Pilot Lights.
- ★ Tests by the well-established emission method for tube quality, directly read on the scale of the meter.
- ★ Tests shorts and leakages up to 3 Megohms in all tubes.
- ★ Tests leakages and shorts of any one element AGAINST all elements in all Tubes.
- ★ Tests BOTH plates in rectifiers.
- ★ Tests individual sections such as diodes, triodes, pentodes, etc., in multi-purpose tubes.
- ★ New type line voltage adjuster.
- ★ **NOISE TEST:** Tip jacks on front panel for plugging in either phones or external amplifier will detect microphonic tubes or noise due to faulty elements and loose internal connections.
- ★ Features an attractive etched panel.
- ★ Uses a 4 1/2" square rugged meter.
- ★ Works on 90 to 125 Volts 60 Cycles A.C.

**EXTRA SERVICE**—The Model 450 may be used as an extremely sensitive Condenser Leakage Checker. A relaxation type oscillator incorporated in this model will detect leakages even when the frequency is one per minute.

The Model 450 comes housed in a portable leatherette covered cabinet complete with all operating instructions. Size 13" x 12" x 6". Net weight 8 pounds. Our Net Price

**\$39<sup>50</sup>**

**SUPERIOR INSTRUMENTS CO. Dept. R.G. 227 Fulton St., New York 7, N. Y.**

HALLICRAFTERS ★

HALLICRAFTERS ★

## RECEIVER HEADQUARTERS

*for the Nation*



**B**EFORE the war Bob Henry served the amateurs as the world's largest distributor of communications receivers.

Now Henry Radio is Hallicrafters receiver headquarters for the Nation at war. Hallicrafters Receivers can be supplied on priority. I can usually supply SX28As at \$223.00, S-39s at \$110.00, S20Rs at \$60.00, SX-25s at \$94.50, and PM-23 speakers at \$15.00 at once. It takes longer to supply other models.

Soon, it is hoped, non-priority orders can be filled and Bob Henry can become again Hallicrafters headquarters for the nation at peace.

I have stores at Butler, Missouri, and at 2335 Westwood Blvd., Los Angeles 25, Calif.

*Your orders and inquiries are invited.*

**Bob Henry, W9ARA**  
**HENRY RADIO SHOPS**

Butler, Mo. and Los Angeles, 25, Calif.

### COMPLETE STOCKS

I have in stock some Hallicrafters receivers available for immediate delivery on priority and the following parts without priority: meter rectifiers \$1.95; Trimm headsets, McElroy keys, bugs, oscillators, tubes, transformers, resistors, condensers, etc. Your orders and inquiries invited.

"WORLD'S LARGEST DISTRIBUTOR OF COMMUNICATIONS RECEIVERS"



**FREE TO RADIO MEN**

**COLOR CODE and OHMS LAW CALCULATOR**

Burstein-Applebee of Kansas City offers you this great convenience **FREE**. Easy to work. Solves many problems in a jiffy. **FREE** to radio men, electronic engineers and others in the business. Attach coupon to your letterhead.

**MAIL COUPON NOW**

**BURSTEIN-APPLEBEE CO.**  
1012 MCGEE, KANSAS CITY 6, MO.

Send me **FREE** Color Code and Ohms Law Calculator along with latest catalog.

I am \_\_\_\_\_  
STATE CONNECTION IN INDUSTRY \_\_\_\_\_

NAME \_\_\_\_\_

ADDRESS \_\_\_\_\_

TOWN \_\_\_\_\_ STATE \_\_\_\_\_

**RADIO Wholesale REPAIR**

THIS IS THE ANSWER TO YOUR RADIO REPAIR TROUBLES!

Just SEND us the SET via Railway Express. We REPAIR and RETURN. You ADD MARK-UP AND DELIVER. That's all there is to it.

- Complete Stocks—We can fix 'em all
- 90 day guarantee
- OUR LOW PRICES mean more Markup for you.
- Prompt service

Send that set to

**SHEFFIELD RADIO CO.**  
918 Belmont Ave., Chicago 14, Ill.

**YOUR NEW FREE CATALOG IS READY FOR YOU!**

Radionic's Catalog No. 26 lists hard-to-get radio parts! • Helps you fill your radio and electronic needs. • All parts are available for immediate shipment • All are highest quality. • All are exceptional values.

**SEND TODAY FOR YOUR FREE COPY TO Dept. 6E**

**RADIONIC EQUIPMENT CO.**  
"CHANCELLOR" PRODUCTS  
170 NASSAU STREET, NEW YORK 7, N. Y.

**"WONDER" ELECTRIC BUTTON**

Most interesting electrical apparatus ever discovered. Make your own telephone-Amplifier rooms. Perform hundreds of fascinating experiments. So tiny it can be concealed in dozens of places. Send \$1 now for button and free 5,000 word instruction booklet with 50 illustrated experiments. **SPECIAL OFFER** 6 buttons and booklets sent postpaid for \$5. Write now to

**BUCK MFG. COMPANY** North Aurora, Illinois

(Continued from previous page)  
the second, a two-section filter with condenser input.

In our first problem we desire to secure a certain voltage to the load and to find out what degree of filtering will result under the following conditions:

- Given: Direct voltage to the load: 340 volts.  
Rectification: Full wave, type 80 tube.  
Current: 125 milliamperes, load current.  
Choke: 30 henrys, 160 ohms resistance.  
Condenser: 4.0 Microfarads.  
Power input: 60-cycle.

We wish to find:

The transformer voltage each side of center tap.

The ripple factor to the load.

The actual amount of alternating current voltage at the load.

Our first consideration is the voltage drop in the choke. As the current is .125 amperes and the resistance is 160 ohms, the voltage drop through the choke is 20. The rectifier must therefore supply 360 volts to the filter input. By consulting a tube manual we find the voltage drop, at 125 milliamperes, through the type 80 tube to be 62 volts. The transformer must then supply 360 plus 62 volts or 412 volts. Multiplying this figure by the full-wave rectification factor 1.11 we find that the transformer must deliver 457 volts. A commercial transformer would deliver 450 volts. By using a choke of lower resistance, about 100 ohms, the voltage drop through the choke will be reduced with a subsequent raising of the voltage to the load.

Using formula (3) we find the ripple factor:

$$R.F. = \frac{12}{30 \times 4 \times 10^{-6}} \times 10^{-7}$$

The foregoing expression is equivalent to:

$\frac{12}{120} \times 10^{-1}$   
And the ripple factor (R.F.) equals .01.

As this is equal to  $\frac{E_r}{E_{ac}}$  and the direct current voltage is 340 volts then the actual ripple voltage,  $E_r$  is equal to  $340 \times .01$  or 3.4 volts. It should be remembered that "C" is in farads in all of these formulas. To convert to microfarads from farads the microfarads must be multiplied by  $10^{-6}$ .

The second problem involves a two-section condenser-input filter. We wish to find the ripple voltage and the ripple factor under the given conditions.

Given: Direct current to load: 400 volts.  
Current: 200 milliamperes.  
Full wave rectification.  
Power input: 60 cycle.  
Input condenser: 8.0 microfarads.  
There are two filter condensers, each 4.0 microfarads.

There are two chokes, each 12 henrys, 80 ohms resistance.

To find: Transformer voltage each side of center tap.

Ripple voltage.

Ripple factor.

The problem must work from the load to the power input. The resistance of the chokes is 160 ohms and the current is 2 amperes, therefore the voltage drop through the filter is 32 volts and the voltage input to the first choke of the filter from the condenser must be 432 volts. The input condenser is working into an actual load of 2000 ohms load resistance plus the resistance of the chokes, 160 ohms, or a total of 2160 ohms, total load resistance presented at the input of the first choke of the filter. We now make use of the graphs of figures 3 and 4 for our condenser calculations. Figure 3 is the graph of load resistance,  $E_{ac}$ , and transformer peak voltage. This graph takes into account the re-

**"STATION 25" SENDS NEWS FROM THE FRONT**



Illustration courtesy International Telephone and Telegraph Corp.

The picture above is the artist's conception of Mackay Radio's press station dispatching news from the European battle theatre. The truck-mounted unit was a 5-kilowatt transmitter, with suitable receiving apparatus, and was operated by a crew headed by L. F. Spangenberg, vice-president of Mackay. The makeshift aerial masts were exactly as shown above.

sistance and impedance of the transformer and the rectifier tube or tubes and it is not necessary to add tube voltage drops, as the graph incorporates this figure. The transformer voltage is given in terms of peak voltage. Multiply by 0.707 to find the R.M.S. voltage. We know our load resistance is 2160 ohms; finding the point representing this resistance and going up to the proper capacity curve, then referring to the left-hand column we find that the D.C. at the input condenser terminals under the given conditions is .73 of the peak A.C. voltage, or:

432 equals .73 x A.C. peak voltage and A.C. peak voltage = 592 volts.

Converting to R.M.S. values:

A.C. R.M.S. voltage = .707 A.C. peak and .707 x 592 = 419 volts.

The required A.C. R.M.S. voltage each side of the transformer center tap will be 419 volts.

To find the ripple voltage we consult the graph of Fig. 4 and, finding the load resistance on the base line, go up to the proper capacity curve and read off to the left side of the graph the ripple factor. In this case it is 0.13, which means the actual  $E_r$  at the condenser terminals is  $0.13 \times 432$  or 56.2 volts. The formula for the calculation of the ripple factor of a two-section choke input given at (7) is:

$$R.F. = 10^{-14} \times \frac{206}{L_1 C_1 L_2 C_2}$$

and substituting the given values:

$$R.F. = 10^{-14} \times \frac{206}{12 \times 4 \times 10^{-6} \times 12 \times 4 \times 10^{-6}}$$

$$= 10^{-2} \times \frac{206}{2304} = 10^{-2} \times .089$$

And R.F. = .00089 or .0009

The actual ripple voltage to the load is:  
 $E_r = .0009 \times 400$  or .36 volt

Thus we have found the required transformer voltage, the ripple factor, and the actual ripple voltage.

These calculations are approximate due to the many variable factors involved, such as the reactance and impedance of the voltage source, resistance of the tube used, phase characteristics of the load, the resistance of the load and the amount of current, as well as other factors involved.

Resistance-capacitance filters follow a similar line as the single section choke filter. By study of our first problem and working along like lines but using the proper formula, either (8) or (9), any resistance-capacitance filter calculation can be made.

### BROADCASTERS' INCOME UP

Income of small radio broadcasters was up in 1944, reports the FCC. The average 100-watt broadcaster had a gross income during the year of \$40,985, an increase of 37% over last year. There were twenty-eight 100-watt commercial stations and five non-commercials in operation last year, according to the FCC figures. All reported increase in their net time sales, the increases ranging from a minimum of \$96 to a maximum of \$39,374.

Latest station in the Pacific's Mosquito Network is Radio Okinawa, Radio WXLH. Opened on May 20 by the late Lt. General Simon Bolivar Buckner, it maintains a schedule of five and one-half hours daily during the week and operates continuously from 8 am to 9:30 pm on Sundays.

## TECHNICAL PERSONNEL WANTED

### HELP WANTED TRANSFORMER & SMALL ELECTRIC MOTOR MEN

ENGINEERS  
DESIGNERS  
DRAFTSMEN &  
PATENT DRAFTSMEN  
TECHNICIANS  
RADIO WIREMEN

For war time and post-war design and development of intricate, specialized, hermetically sealed transformers, and special purpose fractional h.p. motors.

Write, giving details about age, experience, past salaries to

### SPERRY

GYROSCOPE COMPANY, INC.  
RESEARCH LABORATORIES  
STEWART AVE. AND CLINTON RD.  
GARDEN CITY, NEW YORK

### ELECTRICAL and RADIO ENGINEERS RADIO TECHNICIANS

For Design, Development and Production Work. Post-war Opportunity. Also Openings for Mechanical Draftsmen, Junior and Senior Designers.  
ALLEN D. CARDWELL MFG. CORP.  
81 Prospect St. Brooklyn

### FIELD SERVICE ENGINEERS

For Domestic and  
Foreign Service  
and

### INSTRUCTORS

Must possess good  
knowledge of Radio  
Essential workers need release.

### HAZELTINE CORPORATION

58-25 Little Neck Parkway  
Little Neck, Long Island

Dielectric heating has been successfully tested as an efficient means of thawing out quick-frozen foods, according to Federal and Radio Corp. Foods could be thawed out many times as fast as with former methods.

### ENGINEERS WANTED

Here's an opportunity to join one of America's largest manufacturers of electronic and communications equipment.

Radio  
•Electrical  
Electronic  
Industrial  
(Job evaluation)  
•Mechanical  
•Factory Planning  
Materials Handling  
Manufacturing Planning

Work in connection with the manufacture of a wide variety of new and advanced types of communications equipment and special electronic products.

Write giving full qualifications,  
or apply to:

R. L. D., EMPLOYMENT DEPT.

### Western Electric Co.

100 CENTRAL AV. KEARNY, N. J.

•Also: C. A. L.

Locust St. Haverhill, Mass.

Applicants must comply with WMC regulations

### RADIO STATION TECHNICIANS

MEN AND WOMEN

for Point-to-Point International  
Radio-Telegraph Stations in the  
United States.

Applicants must possess FCC  
radio-telegraph commercial li-  
cense, and ability to copy Inter-  
national Morse code at about  
20 wpm.

WMC rules observed.

Apply weekdays except Satur-  
days between 10 am and 3 pm

or write

PERSONNEL DEPARTMENT

### RCA COMMUNICATIONS, Inc.

64 BROAD STREET  
NEW YORK 4, N. Y.

Immediate Delivery from

# LAKE

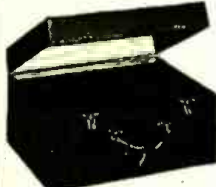

**Radio Cabinets & Parts**

Portable Phonograph cases, of sturdy durable plywood, in handsome brown leatherette finish. Fine blank motor board. As illustrated above. 14" wide, 9 1/2" high. Specially priced at **\$6.95**

Also blank table cabinets of walnut veneer in the following sizes, with speaker opening on left front side: (Note: 7" has center speaker grill.)

1	8 1/2"	L x 5 1/2"	H x 4"	D	\$1.95
2	10 1/2"	L x 6 3/4"	H x 5"	D	\$2.75
3	13 1/2"	L x 7 5/8"	H x 6 1/4"	D	\$3.25
4	16 1/2"	L x 8 3/4"	H x 7 1/2"	D	\$4.50
5	19 1/2"	L x 9 3/4"	H x 9 1/4"	D	\$5.50

\*Speaker Opening in Center of front side. Cabinets available in Ivory color and Swedish Modern. Write for prices.

### POWER TRANSFORMERS

4, 5, or 6 Tube—6.3V at 2 amp.	<b>\$2.45</b>
50 Mil Power Transformer	
7, 8, or 9 Tube—6.3V at 3 amp.	<b>\$2.65</b>
70 Mil Power Transformer	

All types of radio cabinets and parts are available at Lake's lower prices. A large stock is listed in our catalog.



**SERVICEMEN—RETAILERS**  
Join our customer list today.  
Write for our free, new illustrated catalog.

Dept. C

## LAKE RADIO SALES CO.

615 W. Randolph Street, Chicago 6, Ill.



## CANNON BALL

is a good Headset guaranteed to satisfy you. For sensitivity, clarity of tone, dependable performance, use a Cannon-Ball Headset. Folder R-8 illustrates complete line. Write

Scientifically Built Heavy but magnetic Recently increased their efficiency.

**C. F. CANNON COMPANY**  
SPRINGWATER, N. Y.

**Headset Headquarters**

## Get Started in Radio

### 10 "HOW-TO-DO" BOOKS

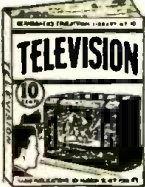

Get a solid foundation in radio by means of these 10 timely text books. Each clearly written, profusely illustrated, contains over 15,000 words. You'll be amazed at the wealth of information tucked into these handy books. Excellent for reference—ideal for technical library. Your money back if not satisfied.

**10¢ each** 5 for 50¢  
10 for \$1.00  
PREPAID

We cannot fill orders for less than 5 books.

- |  |                                     |
|--|-------------------------------------|
| No. 1—How To Make Four Degr. Short Wave Sets                       | No. 6—How To Have Fun With Radio    |
| No. 2—How To Make The Most Popular All-Wave 1 and 2 Tube Receivers | No. 7—How To Read Radio Diagrams    |
| No. 3—Alternating Current for Beginners                            | No. 8—Radio for Beginners           |
| No. 4—All About Aerials  | No. 9—Simple Electrical Experiments |
| No. 5—Beginners' Radio Dictionary                                  | No. 10—Television                   |
- Remit by check or money order—register letter if you send cash or stamps.

RADIO PUBLICATIONS, 25R West 87'way, New York (7)

Do you need

## BINDING POSTS?



The XL PUSH POST with its Spring Action assures Constant Contact and quick connection. Manufactured in All Aluminum Type M at 12¢ each. Aluminum Body, Bakelite Top Type B1 at 15¢ each. Types CP or NP. ALL BRASS—STAINLESS STEEL SPRING & PIN. PROVEN BY 240 HR. SALT SPRAY TEST as NON-CORROSIVE at 28¢ each.

Manufacturers and Dealers Liberal Discounts

## X. L. RADIO LABORATORIES

420 West Chicago Ave., Chicago 10, Ill.

# Available Radio-Electronic Literature

Manufacturers' bulletins, catalogs and periodicals.

A NEW SERVICE FOR RADIO-CRAFT READERS: In order to save your time, postage and incidental work in writing a number of letters to different manufacturers to secure the various bulletins offered, proceed as follows:

On your letterhead (do not use postcards) ask us to send you the literature which you designate. It is only necessary to give us the numbers. We will then send your request directly to the manufacturers, who in turn will send their bulletins or other literature directly to you.

### 153—MICA CAPACITORS.

Issued by Solar Mfg. Co. A 36-page catalog of condensers built to joint Army-Navy specifications, with some introductory matter.—*Gratis to members of the radio and communications industries.*

### 154—MICROMETER FREQUENCY METER ENGINEERING DATA SHEETS.

Published by Lampkin Laboratories. An instruction book covering the company's Type 103 and 105 instruments. In addition to specifications, circuit diagrams, parts lists and operating instructions, the booklet also contains expositions of the design, construction and principles of the instruments, described.—*Gratis to interested parties.*

### 155—ELECTRICALLY SPEAKING. (Cutler-Hammer Co.)

A book describing the wide range of products manufactured by the company, covering all branches of production, but without the detail of a catalog. Readers are referred to bulletin numbers for further information on each of the lines described.—*Gratis to interested parties.*

### 156—CATALOG.

Published by General Cement Mfg. Company. This company's latest catalog describes their complete line of material for the technician, serviceman, or researcher. It includes all of the old familiar items still available and a few new ones, to bring this condensed catalog up to date.—*Gratis*

### 157—PILOT LIGHT ASSEMBLIES.

Published by Gothard Manufacturing Co. This is a new combination catalog and data book on pilot light mountings and jewels, with dimensions and specifications on both.—*Gratis*

### 158—NORELCO ELECTRONIC PRODUCTS.

Published by North American Phillips Co. The new 8-page condensed catalog covers cathode-ray transmitting, power and amplifier tubes in addition to a large selection of X-ray equipment.—*Gratis*

### 159—VIBRATION MEASUREMENT.

Equipment designed by General Electric for the measurement of vibration is described in this 8-page bulletin. The characteristics of three different types are discussed, photos and graphs being included. Tables give the correct type to use for different applications.—*Gratis*

### 160—RESISTANCE WELDING.

A General Electric electronic voltage-regulating compensator is described in this product announcement. Poor resistance welds caused by voltage variations are eliminated through its use. The principle of the method is given and resulting advantages listed.—*Gratis*

### 161—DRY ELECTROLYTICS.

A 26-page of Sprague dry electrolytic condensers of varied sizes and containers. Special motor-starting condensers are listed, also. Several pages of application notes give the change of capacitance with change of temperature. Tolerances as to capacitance, D.C. leakage and surge voltage are tabulated. There are also provided interesting tables which permit determination of container size from knowledge of voltage rating and capacitance.—*Gratis*

### 162—RCA CERAMIC CAPACITY COLOR CODING DATA SHEET.

This is a reprinted section of the March 1945 *Radio Service News* giving data on the color coding of ceramic capacitors. While not itself printed in color, it explains the system of coding by designations of colors. Individual copies of the folder available on request.—*Gratis*

### 163—PANORAMIC RECEPTION.

Published by Panoramic Radio Corporation. It deals with the techniques of panoramic reception for the amateur radio operator. Written for the ham in the terms that he uses.

Watching for CQ's, answers to CQ's, operation of nets, choosing a spot in the band, helping a brother ham, reading signal strength and logging frequencies are some of the topics discussed in this booklet.—*Gratis*



Suggested by: Loc McNelis, Luzerne, Pa.

The Vanishing American

# Communications

## TECHNICAL APPROACH SUITS THIS READER

Dear Editor:

Speaking from a personal viewpoint only, may I express my thanks for your policy of adopting a slightly more technical approach and theoretical treatment in some of your articles? I confess to having been amused and irritated by "pictorial" diagrams and "non-technical" descriptions in the past; however, I realize that one must learn to crawl before he can walk. Yet, it would seem that the average serviceman would have enough curiosity to progress beyond that stage.

I am not a radio serviceman in the usual sense; I am a broadcast operator. I did not have a technical education, but I availed myself of the courses offered without charge in the E.S.M.W.T. program, and have spent a few dollars on textbooks over a period of years. As a result, I have found a great deal of enjoyment in acquiring enough mathematical knowledge to understand most technical discussions of electronic theory and application.

I have known a number of radio servicemen; nearly all of them periodically express an intention to learn enough simple mathematics to enable them to read the trade journals intelligently. Practically none of them ever do it. This is simply (I am leading with my chin) pure laziness; or, worse yet, a sort of pride in ignorance. How often have I listened to a serviceman sneer at the engineer as an impractical dreamer and

an unnecessary evil—while his hands were occupied with the tools, instruments, and circuit components developed and designed by one of those engineers!

Most servicemen cannot even perform the simplest calculations using Ohm's law for direct currents. Their comments on their chosen profession remind me of some women who drive a car and cheerfully boast that they would not know a spark plug from a water jacket. But I fear the handwriting is on the wall. After a few of the profession have killed themselves attempting to work on a television receiver; and after some others, who are unable even to work on the short-wave channels of a pre-war set, find that an F.M. receiver is operating far higher in the spectrum and cannot be serviced by guesswork and brute strength—then, perhaps, servicemen will begin to learn the simplest fundamentals of radio theory.

Meanwhile, congratulations on your brave efforts to lead the way out of the present lethargic state of affairs. "A prophet is not without honor, save in his own country"—how well it applies! Keep on ducking the brickbats, and don't turn back. It is better, I think, to help a few men who see ahead than it is to pander to the majority who seek encouragement in their present course—which is to blunder along without worrying about tomorrow.

DEAN H. ELLIOTT  
Engineering Staff, KVOR  
Colorado Springs, Colo.

## POSTWAR SERVICEMEN MUST CO-OPERATE

Dear Editor:

Radio servicemen of the future must co-operate rather than try to cut each other's throats, as they have done in the past. It is my belief that after the war there will be plenty of repair work on electronic equipment (what with the citizens' radios, industrial electronic equipment, television, and other high frequency equipment) for those of us who can handle it.

We need not expect any serious competition from amateurs, tinkers, and men who have completed a three-month or even a six-month radio course in the army. Those men are trained to do specialized jobs on

special equipment (and are doing well) but will not be able to handle general radio and electronic repair work. A man can't learn that in six months! It is a matter of several years' of study and practical experience.

It behooves those of us who wish to stay in business after the war, to study and cooperate among ourselves, if we wish to build up a reputation for quality work, and take away the bad name which "Reader's Digest" and other publications gave us before the war. So, what say, fellows! Let's organize and cooperate.

PVT. JOHN R. SIMPSON,  
Camp Shelby, Miss.

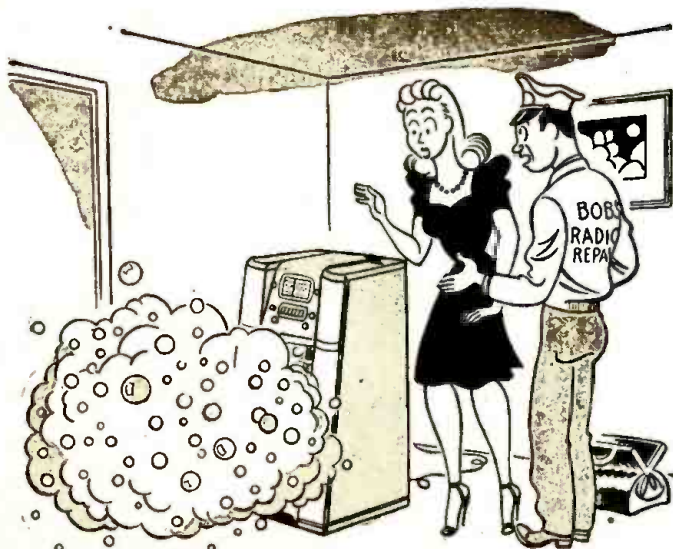

"Lady, there's nothing wrong with your radio. You just have to stop listening to those soap programs!"  
Art Jackson

## NOW—A REALLY HIGH-POWERED— Radio Engineering Library

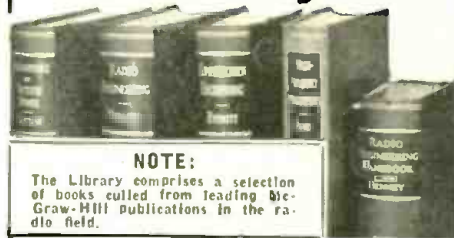

### NOTE:

The Library comprises a selection of books culled from leading McGraw-Hill publications in the radio field.

- especially selected by radio specialists of McGraw-Hill publications
- to give most complete, dependable coverage of facts needed by all whose fields are grounded on radio fundamentals
- available at a special price and terms

THESE books cover circuit phenomena, tube theory, networks, measurements, and other subjects—give specialized treatments of all fields of practical design and application. They are books of recognized position in the literature—books you will refer to and be referred to often. If you are a practical designer, researcher or engineer in any field based on radio, you want these books for the help they give in hundreds of problems throughout the whole field of radio engineering.

5 VOLUMES, 3319 PAGES, 2289 ILLUSTRATIONS

1. Eastman's FUNDAMENTALS OF VACUUM TUBES
2. Terms' RADIO ENGINEERING
3. Everitt's COMMUNICATION ENGINEERING
4. Hund's HIGH FREQUENCY MEASUREMENTS
5. Henney's RADIO ENGINEERING HANDBOOK

10 days' examination. Easy terms. Special price under this offer less than books bought separately. Add these standard works to your library now; pay small monthly installments, while you use the books.

10 DAYS' FREE EXAMINATION—SEND COUPON

McGraw-Hill Book Co., 330 W. 42nd St. New York 18  
Send me Radio Engineering Library, 5 vols., for 10 days' examination on approval. In 10 days I will send \$3.00, plus few cents postage, and \$3.00 monthly till \$24.00 is paid; or return books postpaid. (We pay postage on orders accompanied by remittance of first installment.)

Name .....

Address .....

City and State .....

Position .....

Company ..... RC-8-45

## LEARN ELECTRICITY 12 WEEKS SHOP TRAINING



### "LEARN BY DOING" IN COYNE SHOPS

Electricity offers you opportunity for the best jobs today— with a real peace time future. "Learn by Doing," on real machinery. Earn while learning. Right now I'm offering extra training in Industrial Electronics at no extra cost. Lifetime employment. Service after graduation. Get all-around practical training at Coyne's 12 weeks. If you are short of money finance your training. Mail coupon now for Free Book. VETERANS—Coyne is equipped to train those who qualify for training under G. I. Bill of Rights. We also have facilities for men with physical disabilities whether due to war or other cause.

H. C. Lewis, President, COYNE ELECTRICAL SCHOOL

500 S. Paulina St., Dept. CS-81, Chicago 12, Illinois

Free book, details  Physical disability  G. I. Bill of Rights

NAME .....

ADDRESS .....

CITY .....

STATE .....

## BUILD YOUR OWN!

### \*FAST-FREEZER\* It's Easy and Fun

Every amateur will be proud to build this modern household necessity. It just takes a few hours of your spare time to build, and operates electrically on any voltage. There's fun in building and profit in using this handy freezer. Saves up to 75%.

NO EXPERT KNOWLEDGE NEEDED

Our plans are simple and easy to follow and this 8 or 40 cubic foot size can be built of new or used parts. Mail \$1 bill check or money order for complete plans and catalog.

LEJAY MFG., 456 LeJay Bldg., Minneapolis 8, Minn.

**GEOPHYSICAL  
PROSPECTING  
PRINTS  
(TREASURE  
FINDERS)**

**50¢ EACH  
7 FOR  
\$3.—**

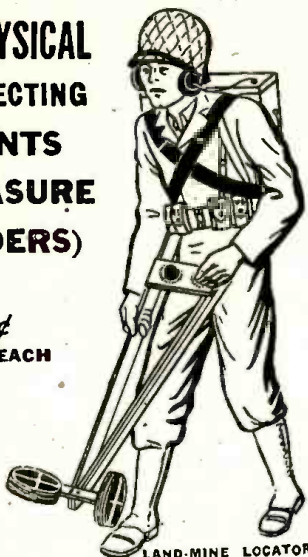

LAND-MINE LOCATOR

With any one of the modern geophysical methods described in the Blue-Print patterns, radio outfits and instruments can be constructed to locate metal and ore deposits (Prospectings); finding lost or buried treasures; metal war relics; sea and land mines and "duds"; mineral deposits; subterranean water veins; oil deposits (under certain circumstances); buried gas and water pipes; tools or other metallic objects sunken in water, etc., etc.

- Folder No. 1. Radiodetector pilot. Construction and use of 2 tube transmitter and 3 tube receiver. Reflected wave principle. Visual and aural signals.
- Folder No. 2. Harmonic Frequency Locator. Radiates low frequency wave to receiver. Aural signals.
- Folder No. 3. Beat Note Indicator. 2 oscillators. Visual and aural signals.
- Folder No. 4. Radio Balance Surveyor. Balanced loop principle. Modulated transmitter. Visual and aural signals.
- Folder No. 5. Variable Inductance Monitor. Inductance principle. Aural signals.
- Folder No. 6. Hughes Inductance Balance Explorer. Bridge principle. Aural signals.
- Folder No. 7. Radiodine Prospector. Balanced loop principle. Very large field of penetration. Aural signals.

Each set of blueprints and instructions enclosed in heavy envelope (9 1/2" x 12 1/2"). Blueprints 22" x 34"; eight-page illustrated 8 1/2" x 11" folder of **50c** instructions and construction data. Add 5c for postage

The complete set of seven folders ..... **\$3.00**  
Shipping weight 2 lbs. (add 25c for shipping anywhere in U.S.A.)

Send Stamps, Cash or Money Order to

**TECHNIFAX**

RC-8-45

1917 S. STATE ST. CHICAGO, ILL.

**TECHNIFAX** 1917 So. State, Chicago, 16, Ill.

Enclosed herewith \$..... for which mail to address below:

Treasure Finder No. 1, 2, 3, 4, 5, 6, 7. Complete set of seven folders.

NAME .....

ADDRESS .....

CITY ..... STATE RC-8-45

**PATENTS—TRADE MARKS**

Booklet concerning Inventions & Patents Form "Evidence of Conception" with instructions for use and "Schedule of Government and Attorneys Fees"—Free  
**LANCASTER, ALLWINE & ROMMEL**  
Registered Patent Attorneys

486 Bowen Bldg. Washington 5, D. C.



**FILMGRAPH**

**"MILES AHEAD OF OTHERS"**

Thousands of uses for Miles Filmgraph Recorder-Reproducer. Instantaneous recordings and playback at amazingly low cost. Write for Bulletin and further details.

**MILES REPRODUCER CO., Inc.**  
812 Broadway (Best. RC-8) New York 3

★ BUY AN EXTRA WAR BOND ★

**RADIO IS ELECTRONICS**

Dear Editor:

Just two cents worth about electronics. I've been reading in *Radio-Craft* that several readers are getting tired of electronics. When they get tired of electronics, they are also getting tired of radio, for radio like television is but one phase of electronics.

We could use more articles on the construction of electronic devices but at present it's pretty hard to get the necessary parts for construction.

RICHARD BRAUER  
Beverly Hills, Calif.

**IT'S STILL THE DESIGN!**

Dear Editor:

I am particularly interested in an article by Louis Hagen in the June, 1945, issue of your worthy magazine, bearing the title "It's the Design." Few radio writers have hit the nail on the head more squarely. I have learned with supreme disgust that—if there are only two ways to design any part of a radio, one an easy way and the other the hard way—**THE RADIO ENGINEER WILL ALWAYS CHOOSE THE HARD WAY.**

A good example is the dial cable or belt. In a very few cases, the set can be removed from its cabinet and a new belt installed in a fraction of the time that it takes to remove others from the cabinet. In many cases it is so difficult to remove the chassis from the cabinet that most servicemen often wish that the Creator had endowed them with six hands instead of two. Is it possible to demonstrate more effectively the absence of mechanical efficiency than through the necessity for 50,000 servicemen to carry dial belts which vary in steps of 1/32 of an inch in length—when it is necessary for the manufacturer to issue a bulletin on the installation of a dial cable—**IT'S THE DESIGN.**

Could anyone give one single logical reason for the existence of the Loctal type tube? Off hand I do not know the exact number of tubes in the present loctal line, but suppose there are more than 100, then the result of its design is that 50,000 servicemen must have a minimum stock of at least 50,000 tubes requiring a useless investment of more than \$5,000,000. The advantage of the loctal over the octal is NIL. For example, I have on my bench a radio set with a 7G7 in the R.F. and a 7B7 in the I.F. In each of these sockets I have tried a 7G7, 7V7, 7H7, 7A7, 7B7, with results hardly noticeable. Some sets use a 6A8 or 6K8 or 6J8 or 6D8 or 7A8 or 7B8 or 7J7 or 7S7. Eight tubes to do the work of one, if radio engineers were curbed—**IT'S THE DESIGN.**

Perhaps the prize boner ever pulled in the design of the all important radio tube is the 5Y3 and 5Y4. Could anyone give a logical reason for the existence of these two types?

Mr. Hagen hit the nail right on the head in the paragraph on "Chassis Design." Chassis design, that is, the physical arrangement of parts, is a good example of the fact that seldom do you find mechanical and electrical ability in the same person. The man who suffers from improper design is the man who holds up the industrial radio ladder. **IT'S THE DESIGN.**

We hope, and it is a forlorn hope, that the postwar radio will eliminate most of the headaches and we hope a very vain hope indeed that the manufacturers will at least standardize those parts which have no bearing on their particular brand.

JAMES A. ROBINSON  
Methuen, Mass.

*Index to advertisers*

Allied Radio Corporation	736
Amperite Company	735
Audel & Co., Theo.	750
Buck Mfg. Co.	742
Burgess Battery Co.	723
Burstein-Applebee Co.	742
Cannon Co., C. F.	744
Capitol Radio Eng. Institute	724
Cardwell, Allen D.	743
Centralab	715
Concord Radio Corporation	711
Coyne Electrical School	734, 738, 745
DeForest's Training, Inc.	685
Eastern Amplifier Corp.	Back Cover
Echophone Radio Co.	683
Electronic Winding Co.	729
Galvin Mfg. Co.	Inside Front Cover
Gateway Publishing Co.	737
General Cement Mfg. Co.	739
General Electric Co.	733
Hazeltine Corporation	743
Henry Radio Shops	741
Hudson Specialties Co.	740
International Detrola Corp.	714
International Resistance Co.	713
Lake Radio Sales Co.	744
Lancaster, Allwine & Rommel	746
Lejay Mfg. Co.	745
Leotone Radio Co.	738
McElroy, T. R.	739
McGraw-Hill Book Co.	745
McMurdo Silver Co.	719
Mallory & Co., Inc., Inside Back Cover	
Meissner Mfg. Co.	707
Miles Reproducer Co.	746
Murray Hill Book Co.,	
Technical Division	730, 731
National Plans Institute	747
National Radio Institute	679
National Schools	687
National Union Radio Corp.	680
Ohmite Mfg. Co.	726
Onan & Sons, D. W.	735
Opportunity Adlets	734
Personnel Help Wanted	743

**RADIO SCHOOL DIRECTORY**

Page 748

- American Radio Institute
- Candler System
- Capitol Radio Engineering Institute
- Commercial Radio Institute
- Lincoln Engineering School
- Melville Radio Institute
- RCA Institutes
- Tri-State College

RCA Communications	743
Radcraft Publications	728
Radiart Corporation	716
Radio Corporation of America	688
Radio Electric Service	739
Radio Publications	744
Radio Service	739
Radio & Television Supply Co.	734
Radio Wire Television	732
Radionic Equipment Co.	742
Radolek Company	737
Raytheon Mfg. Co.	749
Sheffield Radio Co.	742
Sperry Gyroscope Co.	743
Sprague Products Co.	684, 709
Sprayberry Academy of Radio	681
Superior Instruments Co.	741
Supreme Instruments Corp.	733
Supreme Publications	727
Technical Division,	
Murray Hill Book Co.	730, 731
Technifax	746
Triplett Elec. Instrument Co.	686
Universal Tool Co.	738
Western Electric Co.	743
Weston Elec. Instrument Co.	725
Wholesale Radio Laboratories	721
X. L. Radio Laboratories	744

# BOOK REVIEWS

**AVIATION RADIO**, by Henry W. Roberts. Published by Morrow. Stiff cloth covers, 5½ x 8 inches, 637 pages. Price \$5.00.

Aviation radio enthusiasts, radio men and the would-be aviation radioman will find this book invaluable. Here in one volume is the complete story of aviation radio. The novice will find himself taken through the elementary story of radio in aviation to aviation radiometeorology in easy-to-follow steps. The text is neither insultingly simple nor overburdened with the jargon of the engineer.

Principles of radio direction-finding and direction-finding equipment are thoroughly covered. Radio aids, instrument landing, traffic control, ground and airborne communications equipment and testing of aircraft radio apparatus are explained. The entire book is written in somewhat of a story style with all formulae and facts cleverly interjected.

A section is devoted to the Link trainer and procedures and methods of training the flight cadet.

The chapter on radio navigation gives the reader a firm knowledge of the navigator's position on aircraft, his duties, and the means of plotting a course with and without aeronautical charts. For those planning a career in traffic control, the sections on traffic control and radio regulations will prove a must. The appendix contains the entire "Q" code, including those that apply to aircraft only.

As Dr. Lee DeForest says in his introduction, it is: "Surprisingly topical, up to the minute and keenly alive."

**AN INTRODUCTION TO ELECTRONICS**, by Ralph G. Hudson. Published by The Macmillan Company. Stiff cloth covers, 5½ x 8½ inches, 97 pages. Price \$3.00.

The purpose of this book is to explain the science of electronics and its modern applications in terms that will be understandable to those with only an elementary knowledge of mathematics and physics.

It opens with a thorough treatment of the constitution of matter, taking in atomic structure and composition of the elements, closing the first chapter with a simple treatment of the cyclotron.

The second chapter covers the basic principles of radio theory. Functions of vacuum tubes, conduction in gases and in liquids are explained in such a manner that the beginner in radio, without realizing it, absorbs facts that would otherwise take painful hours of diligent study to acquire.

Once the groundwork is laid, the third chapter introduces the reader to principles of radio communication, concluding with a brief, not-to-technical outline of the principles of FM.

Chapters 4 and 5 review the ideas behind modern-day reproduction of sound and picture apparatus. It also rather briefly reviews the principles behind photoelectric emission, the phototube and television.

The last two chapters are concerned chiefly with higher-power equipment such as is used in industrial electronics, diverging briefly into the field of medical electronics.

This book should find its place amongst the paraphernalia of the laboratory and on the shelves of the service shop.

**EDUCATION ON THE AIR**—The fifteenth yearbook of the Institute for Education by Radio. Edited by Josephine H. MacLachy. Published by the Ohio State University. Stiff cloth covers, 5½ x 9 inches. 300 pages. Price \$3.00.

Radio broadcasting and its effects on the average listener are dissected in complete detail in this volume. This, the fifteenth yearbook, covers such topics of the moment as "Radios Role in Understanding," "The Voice of America Overseas," "Combat Reporting," "The Postwar Situation" and "Television Broadcasting After The War."

The complete scripts of the more informative and educational programs of the past year are given in their entirety. One in particular on broadcasting in wartime, entitled "North Atlantic Testament" is outstanding.

An interesting section is the one devoted to studies of listening. The Program Analyzer is explained and the Nielsen Radio Index is described, together with the results on various types of programs.

The researcher and the educator would find this book of value in determining the trends of program broadcasting, its effects—and its causes. The section on training radio journalists goes into program make-up, and news programs in detail. Styles of script and the effect they have on the listening audience are compared to the same items in the local newspaper, together with an exposition of what would happen if the radio journalist were to present the news item as it appears in print.

**U. H. F. RADIO SIMPLIFIED**, by Milton S. Kiver. Published by D. Van Nostrand Co. Stiff cloth covers, 5½ x 8½ inches, 238 pages. Price \$3.25.

A welcome addition to the too-thin ranks of non-mathematical books on the ultra-high-frequencies, this work will find a place on the shelf of many technicians and students. The presentation is such as to be easily understood by anyone who has a good elementary knowledge of lower-frequency radio. Though marred in a few places by reversion to text-book styles of handling, the bulk of the material is clearly presented in a practical manner.

The opening section deals with the effects which result from increasing frequency in ordinary vacuum-tube circuits, with special attention to transit-time phenomena, and goes into a short description of Barkhausen-Kurz oscillators. Three chapters, covering 16 pages, are then given to the Magnetron. A chapter on the Klystron, beginning with notes on cavity resonators, covers the next 15 pages.

The fourth chapter is a very complete exposition of transmission lines at ultra-high frequencies. The subject is approached in a fresh manner which may be helpful to teachers or students who have not been entirely satisfied with other presentations. Wave guides are treated equally well and as fully in a long chapter.

Another full chapter is devoted to cavity resonators, and one to U.H.F. antennas. This latter is especially detailed for an elementary work. Chapters on measurements at high frequencies and on wave propagation at ultra-high frequencies close the book.



FREE WANT-AD SERVICE

## CIVILIAN RADIO JOBS WANTED

By Former Soldiers, Sailors, Marines

Radio-Craft offers its help-wanted columns free for the use of honorably discharged men in the armed services. State the type of position you seek, preferred locality, your experience, education, and other details. Confine ad to 50 words, or less. Supply name, address, service unit and serial number. Address RADIO-CRAFT, Classified Ad, Dept. 25, West Broadway, New York 7, N. Y. Your ad will contain a box number and replies will be forwarded to you.

### AVAILABLE

**Business Administrator** — Foreign service preferred. Graduate, Ohio State (B.Com.) Experience in Mechanical Engineering (A.M.I.E.T.), Cost Accounting & Audits (F.A.S.A.), Statistics and Research, Public Relations, Business Correspondence and Office Administration—able to assume responsibility. British subject — honorably discharged veteran, and possessing valid Passport and Labor Exit Permit to leave country. Speak French & German. Age 30, excellent references. Apply in Confidence: Advertiser, P. O. Box 90, Station "H", Montreal 25, Canada.

## 500 FORMULAS TO SUCCESS

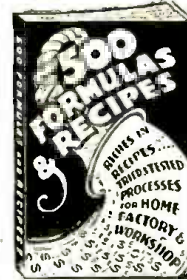

MANY million dollar firms started with a single formula, for which they paid a big price. Here you have 500 — no less — tried and tested formulas, recipes and processes for making things . . . all at the ridiculously low price of 25c.

Here is your opportunity to start a business with but a few dollars' capital and with undreamed of profits in prospect. You can also use these formulas in your own home to cut household expenses to the bone. Or you can put them to use in your work-

shop to cut costs as much as 100%. Quit paying out many dollars in profits to manufacturers, wholesalers, and dealers, when you can make the same thing yourself for a few cents. It's so easy when you follow our simple instructions.

66 PAGES, 32000 WORDS IN TEXT

Send for "500 FORMULAS AND RECIPES" today. Enclose 25c, that's all! You won't be asked for another cent now or later. Sold on a money-back guarantee.

## NATIONAL PLANS INSTITUTE

P. O. BOX 26 R, STATION N, New York 23, N. Y.

# RADIO SCHOOL DIRECTORY

PREPARE NOW FOR POST-WAR RADIO AND ELECTRONICS

MAKE a place for yourself in a new world of radio and electronics—a world in which revolutionary electronic developments will require highly specialized technical knowledge. Take a good course now to fit yourself for a good paying job. The training you need can be supplied by one of the schools advertised in this publication.



**RADIO**

Train with professionals. Complete, intensified courses; Repair & Maintenance, Communications, High-speed telegraphy, SSB transcription, FCC exams, etc. High School Students accepted for training as Merchant Marine Radio Officers. Gov't sponsorship available to veterans.

*"A Radio School managed by radio men."*  
45 W. 45th St., Dept. RC, New York 19, N.Y.

**MELVILLE RADIO INSTITUTE**

**RCA INSTITUTES**

Offer thorough training courses in all technical phases of

**Radio and Television**

DAYS—EVENINGS WEEKLY RATES

**VETERANS:** RCA Institutes is approved under G. I. Bill of Rights For Free Catalog Write Dept. RC-45

**RCA INSTITUTES, Inc.**  
A Radio Corporation of America Service  
75 VARICK STREET NEW YORK 13, N. Y.

**COMMERCIAL RADIO INSTITUTE**

*A radio training center for twenty-four years.*

**RESIDENT COURSES ONLY**

Pre-Induction, Broadcast, Service, Aeronautical, Television and Marine telegraphy classes now forming for October 1. Literature upon request. Veteran training. Dept. C., 38 West Biddle St., Baltimore 1, Md.

**RADIO ENGINEERING I**

**DEGREE IN 27 MONTHS**

VETERANS can complete work here in shortest possible time. Special Prep. Dept. Also RE-FRESHER COURSES. Courses also in Civil, Electrical, Mechanical, Chemical, Aeronautical Engineering; Business Administration, Accounting, Secretarial Science. Tuition, living costs low. 62nd year. Cosmopolitan student body. Enter Sept., Jan., Mar., June. Catalog.

**TRI-STATE COLLEGE** 2485 College Ave. ANGOLA, INDIANA

**RADIO**

RADIO Technician and Radio Communications courses. Register now for new classes starting first MONDAY of each month. Day and Evening Classes.

**AMERICAN RADIO INSTITUTE**  
101 West 63rd St., New York 23, N. Y.  
APPROVED UNDER GI BILL OF RIGHTS.

**Correspondence Courses in RADIO and ELECTRICAL ENGINEERING**

**ELECTRICAL ENGINEERING** Get good grasp of wide electrical field. Prepare yourself, at Low Cost, for secure future. Modern, simplified, you can understand quickly. **RADIO ENGINEERING** Extra fine course in radio, public address, photo-electric work. Trains you to be super-service man, real vacuum tube technician. Servicemen needed badly. Diploma on completion. Tuition \$25, either course. Deferred payment plan. Get copies of school catalogs, student magazines, complete details. SEND NOW!

**FREE**

**LINCOLN ENGINEERING SCHOOL** Box 931C-78 Lincoln, Nebr.

**RADIO-TELEVISION**

See Big Ad. Page 724

**ENGINEERING & SERVICING**

New Training Veterans Under "G.I." Bill Prepare now for profitable career! ENTER AT ANY TIME. Residence school classes in Radio-Electronics Engineering, Broadcast & Television Engineering and Servicing. Write for FREE Booklet

Capitol Radio Engineering Institute  
Dept. RC-8, 3224 16th Street, N. W., Washington 10, D. C.

**CODE SENDING SPEED**

**RECEIVING SPEED**

Be a "key" man. Learn how to send and receive messages in code by telegraph and radio. Army, Navy and Commerce need thousands of men. Good pay, adventure, interesting work. Learn at home quickly through famous Candler System. Write for FREE BOOK.

**CANDLER SYSTEM CO.**  
Dept. 3-J, Box 928, Denver 1, Colo., U.S.A.

class A1, AB, AB2, B, etc., has a marked relation to the benefits or otherwise of push-pull.

## PUSH-PULL OPERATION

The above remarks apply equally well to class AB, and class AB2 operation providing the bias is not excessive. The nearer the bias comes to that for distortionless class B1 or B2 operation at full output, the less influence does negative feedback have on power output.

When the output tubes are over-biased in an effort to obtain high efficiency, the application of negative feedback has a very beneficial effect in that it not only improves the wave form, but thereby increases the power output (for a sine wave). This is shown in Fig 4-b where the excess-bias has caused the inverted grid characteristic to be shifted to the left.

One point not considered so far is the effect of the feedback on the stages before which it is applied. As the feedback reduces the gain, greater voltage outputs are demanded of the earlier stages, with a consequent rise of distortion. This is particularly noticeable when triodes are employed in the output stage because triodes require high driving voltages—often over 100 volts peak. In such cases the feedback should not be excessive and should be taken as far back as possible, over at least two stages and preferably three.

The second part of this article, which will appear in an early issue, will deal with application of feedback to the screen circuit.

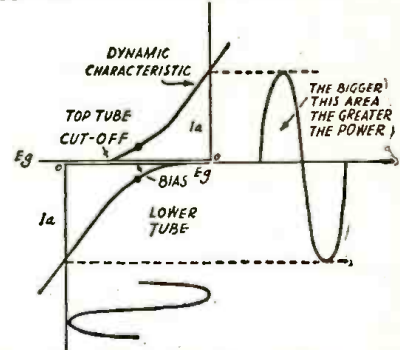
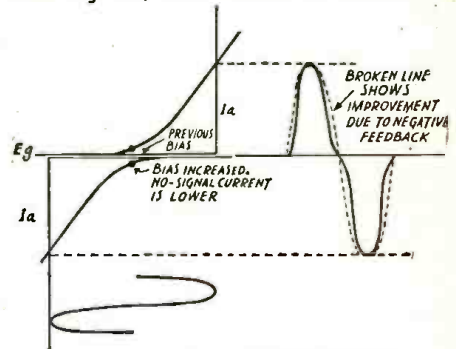

Fig. 4-a, above—Class-B operation, correct bias. Fig. 4-b, below—Effect of excess bias.



## WALLS FOR LIGHTING?

Luminous paint on walls, ceiling and floor of an operating room would eliminate shadows from the surgeon's hand and instruments, and reduce danger from sudden failure of lights during an operation, reports Engineer Morozov of Moscow, U.S.S.R.

The paints, which were thoroughly tested, were of the zinc- or calcium-sulphide type. They give out light about an hour and a half after being irradiated by ultra-violet or sunlight. The walls of a room painted with the compound still give off light, in spite of the fact that all the windows were blown out of the building by a bomb in 1941, and the paint has been exposed to severe Russian weather conditions for three years.

## NEGATIVE FEEDBACK

(Continued from page 702)

a slight increase in distortion. What about the feedback? This is reduced because the gain M is reduced, resulting in an increase of distortion and an over-driving of the output tube due to the excessive signal it gets, resulting in far worse distortion.

The results of applying voltage feedback, assuming that the tube is driven just to its limit at midfrequencies, are summarized in Table I.

One result is that triodes with inverse feedback are very unsatisfactory—they lack "highs" and the bass seems weak.

Pentodes are improved by voltage feedback, providing it is not overdone. In both cases the frequency response curve is flattened by the application of feedback. Many people dislike the "tone" of flat amplifiers—the acoustic output then being very un-flat due to varying efficiency and varying impedance of the speakers!

The table above applies to tubes whether used singly or in class A1 push-pull while most of the earlier remarks on power variation apply to single tubes. When tubes are used in push-pull, the type of operation,

TABLE I

FREQUENCY	TRIODE	PENTODE
Very Low Frequencies.	Distortion increases. Reduction in power.	Slight increase of distortion compared to the decrease in middle register. Reduction in power.
Bass Resonant Frequency.	Large reduction in power. Decrease in distortion.	Slight increase in power. Increase in distortion due to load. Decrease in distortion due to feedback.
Mid frequencies.	Decrease in distortion.	Decrease of distortion.
Highs.	Large Decrease of power. Decrease of distortion.	Slight increase of Power sensitivity over that at midfrequencies. Rise of distortion due to load. Decrease of distortion due to feedback.





**OWI uses RAYTHEON tubes**  
**IN UNIQUE MOBILE RECORDER**

● This "traveling recording studio" of the Office of War Information has everything for making recorded pickups for broadcasting on international short wave. Such important equipment must be the finest that science can provide, so Raytheon High-Fidelity Tubes are used to assure the highest quality reception.

Wherever they are employed, Raytheon Tubes live up to their reputation for fine performance. That is why they are first choice among electronic engineers planning post-war products . . . and first choice among radio service-dealers who are building soundly for the future.

There's a real promise of greater profits and greater customer-satisfaction for service-dealers who feature Raytheon Tubes. And there's a revolutionary Raytheon merchandising program planned, too . . . to help you be more successful than ever before.

**Switch to Raytheon Tubes now!**

*Increased turnover and profits, plus easier stock control, are benefits which you may enjoy as a result of the Raytheon standardised tube type program, which is part of our continued planning for the future.*

**Raytheon Manufacturing Company**  
 RADIO RECEIVING TUBE DIVISION

Newton, Mass. • Los Angeles • New York • Chicago • Atlanta



All Four Divisions Have Been Awarded  
 Army-Navy "E" With Stars



*Listen to*  
 "MEET YOUR NAVY"  
 Every Saturday Night  
 AMERICAN BROADCASTING CO.  
 Coast to Coast  
 181 Stations

**RAYTHEON**  
*High Fidelity*  
 ELECTRONIC AND RADIO TUBES



DEVOTED TO RESEARCH AND THE MANUFACTURE OF TUBES FOR THE NEW ERA OF ELECTRONICS  
 RADIO-CRAFT for AUGUST, 1945

**NEW EDITION  
NOW READY**

# Audels RADIOMANS GUIDE

*Includes* **TELEVISION  
AND ELECTRONICS**

**LARGER - MORE COMPLETE - 914 PAGES - 633 ILLUSTRATIONS - WIRING DIAGRAMS - PHOTOS**

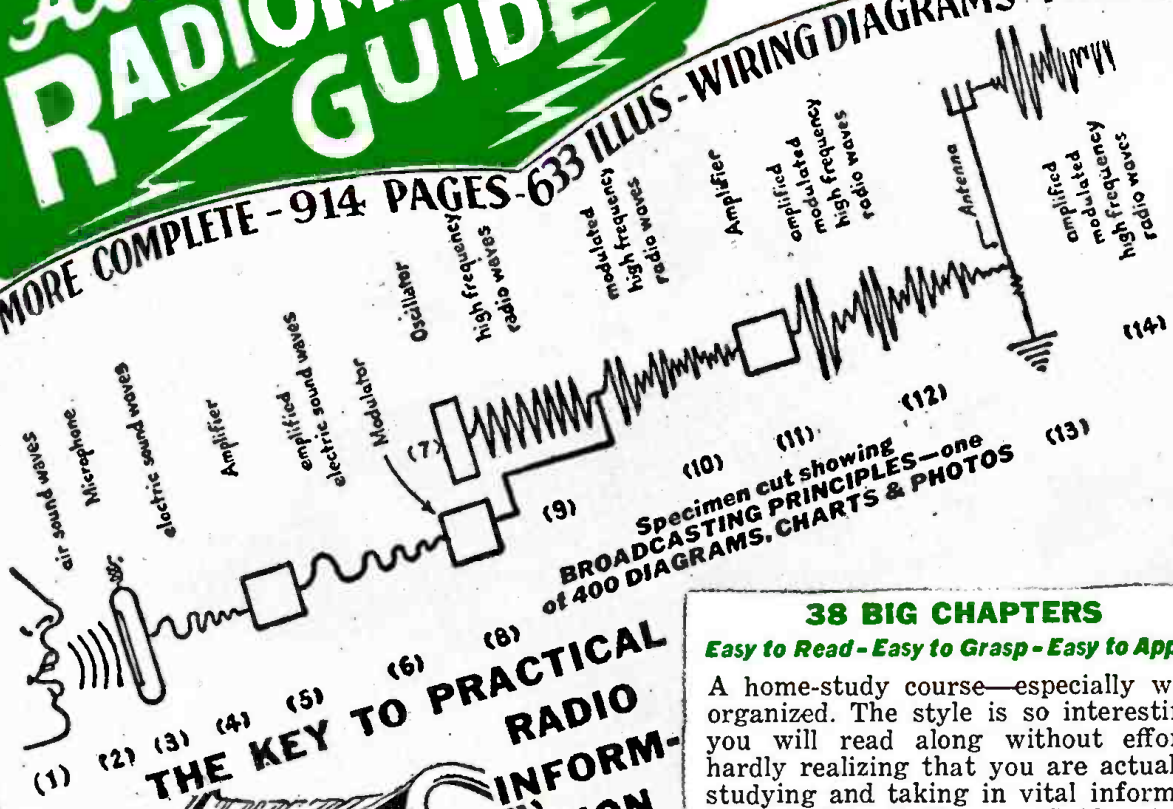

**Specimen cut showing BROADCASTING PRINCIPLES - one of 400 DIAGRAMS, CHARTS & PHOTOS**

**THE KEY TO PRACTICAL RADIO INFORMATION**



*It gives you in usable form pointers on radio, including frequency modulation, television, etc. Also valuable inside information for Aviators, Marines, Commercial Operators and Technicians, Servicemen and Students.*

**Q AND A  
UNIQUE QUESTION and ANSWER METHOD**

**Highly Endorsed**

**1001 RADIO FACTS AND FIGURES  
A Complete Library In One Book**

AUDELS RADIOMANS GUIDE gives authentic Principles and Practices in Construction, Operation, Service and Repairs. Covers clearly and concisely radio fundamentals—Ohm's Law—Physics of sound as related to radio science—Measuring instruments—Power supply—Resistors—Inductors—Condensers—Transformers and examples—Broadcasting stations—Radio Telephony—Receivers—Diagrams—Construction—Control Systems—Loudspeakers—Antennas—AutoRadio—Phonograph Pick-ups—Public Address Systems—Aircraft and Marine Radio—Radio Compass—Beacons—Automatic Radio Alarms—Short Wave—Coil Calculations—Testing—Cathode Ray Oscillographs—Static Eliminations—Trouble Pointers—Underwriter's standards—Units and tables. REVIEW QUESTIONS—READY Reference Index.

**38 BIG CHAPTERS**  
*Easy to Read - Easy to Grasp - Easy to Apply*

A home-study course—especially well organized. The style is so interesting you will read along without effort, hardly realizing that you are actually studying and taking in vital information. Audels Radiomans Guide gives you just the right amount of mathematics required to cope with radio problems successfully. You can solve, with the aid of this extraordinary book, practically every radioproblem that comes up. At your finger tips is a complete index for instant use.



**7 DAYS' FREE TRIAL**

THEO. AUDEL & CO., Publishers  
49 West 23rd Street, New York 10, N. Y.

Mail AUDELS NEW RADIOMANS GUIDE for free examination. If O. K. I will send you \$1 in 7 days; then remit \$1 monthly until \$4 is paid. Otherwise I will return it.

Name \_\_\_\_\_  
Address \_\_\_\_\_  
Occupation \_\_\_\_\_  
Reference \_\_\_\_\_

**MAIL THIS COUPON TODAY**

**\$4 COMPLETE \$1 PAY ONLY 1 MO.**

# NOW..

## "EXACT DUPLICATE" CONTROLS FOR EVERY SERVICE REQUIREMENT

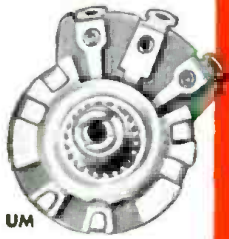

UM



TM

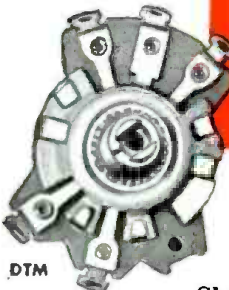

DTM

WITH Mallory plug-in shafts, you're sure of having the *right* replacement control for nearly every job . . . and your entire equipment can be carried in a small-sized kit!

Plug-in shafts, originated and developed by Mallory, do two things: They either replace the original shaft exactly—or they can be made into exact replicas by simply cutting to length!

For household receivers, a kit of eight shafts will answer most of your needs (SS 1, 2, 5, 16, 18, 22, 25, 26). Automobile radios require, at most, twenty-two shafts (SS 1, 2, 3, 4, 6, 10, 11, 12, 14, 15, 17, 19, 20, 21, 23, 24, 27, 28, 29, 30, 31, 32). And remember—all these plug-ins fit Mallory UM, TM and DTM controls, each available in a complete range of resistances and tapers.

What a *set-up* for a busy service engineer! Then too, because the line is simplified, your Mallory distributor is *never* out of stock! Let him help you select the proper kit to answer *your* service needs.

Shaft illustrations are approximately 1/2 actual size.

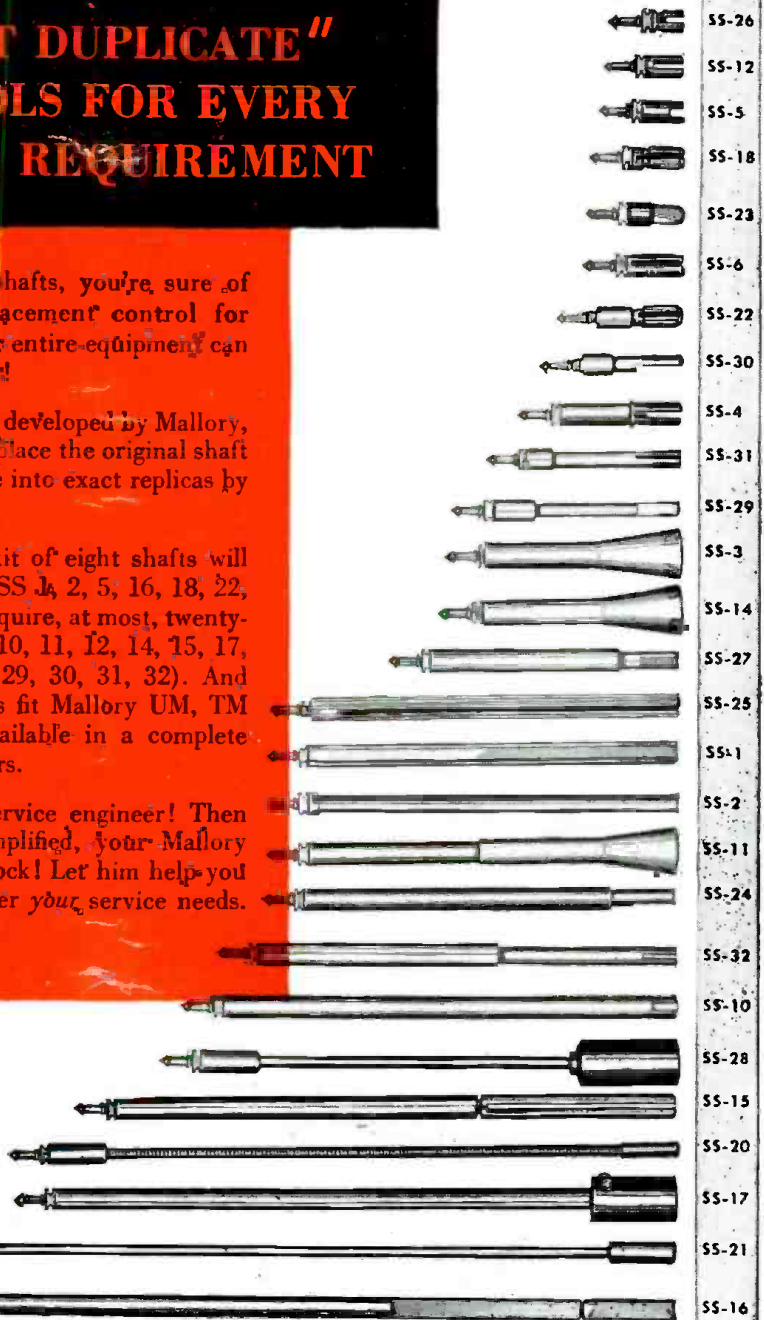

### MALLORY PLUG-IN SHAFTS ARE EASY TO USE!

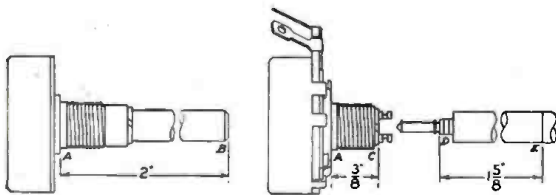

Measure the original.

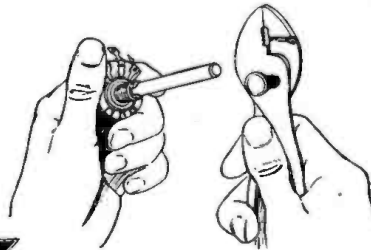

Tap sharply. Pounding is not necessary—it may damage the control.

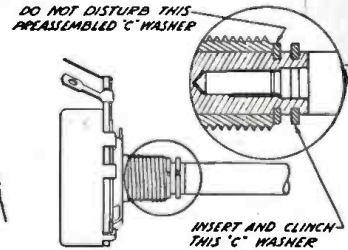

This pre-assembled "C" washer needs no adjustment—just insert and clinch it.

P. R. MALLORY & CO., Inc., INDIANAPOLIS 6, INDIANA



More than ever—  
ALWAYS  
INSIST ON

P. R. MALLORY & CO. Inc.  
**MALLORY**  
APPROVED  
PRECISION PRODUCTS

VIBRATORS • VIBRAPACKS\* • CONDENSERS  
VOLUME CONTROLS • SWITCHES • RESISTORS  
FILTERS • RECTIFIERS • POWER SUPPLIES

ALSO MALLORY "TROPICAL" DRY BATTERIES, ORIGINALLY DEVELOPED BY MALLORY FOR THE U. S. ARMY SIGNAL CORPS, NOT PRESENTLY AVAILABLE FOR CIVILIAN USE.

\*Trademarks

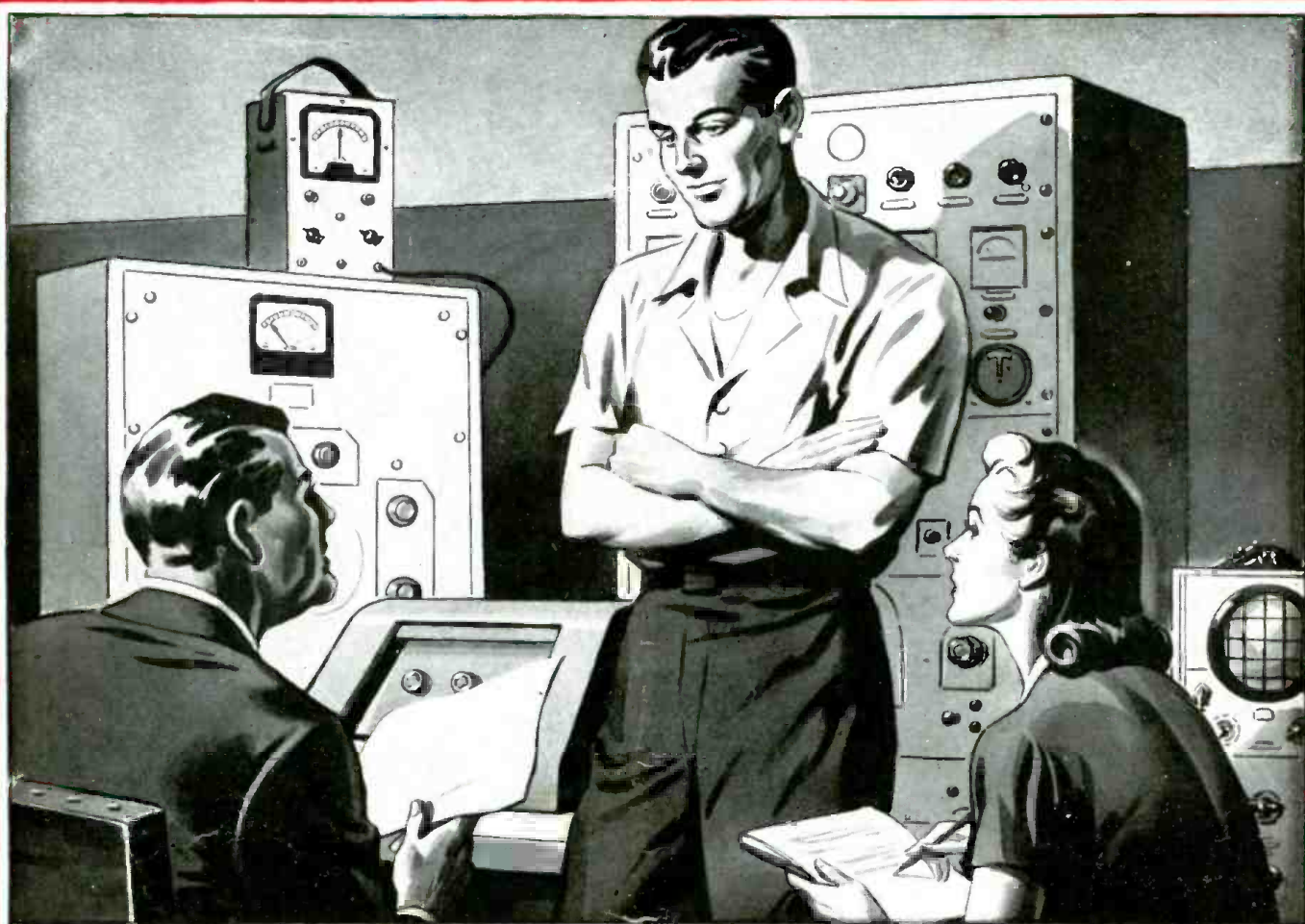

## Yes...the "Lab" work is *Complete!*

OUR post-war plans, policies and perfected line of Eastern sound equipment have long ago passed the stage of draft-board design and laboratory tests! We're "in the groove"—ready to go! Based on our many years of experience, the new Eastern equipment incorporates the many

wartime techniques which we have been building into *quality* units for Uncle Sam.

For details and information please fill out and mail the Coupon today. Eastern Amplifier Corporation, 794 East 140th Street, New York 54, New York.

# **EASTERN AMPLIFIERS**

*This is Your Ticket*

for complete information on our post-war line and the details of our proposition.

EASTERN AMPLIFIER CORPORATION, Dept. 8-L  
794 East 140th St., New York 54, N. Y.

We are  JOBBERS,  DEALERS,  A SERVICE ORGANIZATION,  SOUND SPECIALISTS. We're definitely interested in your post-war line, your policy, your proposition. Mail us complete information, without obligation.

COMPANY NAME .....

ADDRESS .....

CITY .....ZONE.....STATE.....

INDIVIDUAL .....TITLE.....

# ADV Plans, LLC

## Copyright Notice:

The entire contents of this CD/DVD are copyright 2014 by ADV Plans, LLC. All Rights Reserved.

Reproduction or distribution of this disk, either free or for a fee is strictly prohibited. We actively monitor and remove listings on eBay thru Vero.

You are free to copy or use individual images in your own projects, magazines, brochures or other school projects.

Only the sellers listed here are authorized distributors of this collection:  
[www.theclassicarchives.com/authorizedsuppliers](http://www.theclassicarchives.com/authorizedsuppliers)

Please view our other products at  
[www.theclassicarchives.com](http://www.theclassicarchives.com),  
or our ebay stores:

[TheClassicArchives](#)  
[ADVPlans](#)  
[SuperShedPlans](#)

